

06						
05						
04						
03						
02						
01						
ΕΚΔΟΣΗ	ΗΜΕΡΟΜΗΝΙΑ	ΜΕΛΕΤΗ	ΣΧΕΔΙΑΣΗ	ΕΛΕΓΧΟΣ	ΕΓΚΡΙΣΗ	ΠΑΡΑΤΗΡΗΣΕΙΣ



Το παρόν συνοδεύει την

Απόφαση της ΔΠΑΝΣΜ με αριθ. πρωτ.:

1490548/50452

4361/14.11.2019

ΕΡΓΟΔΟΤΗΣ

ΔΗΜΟΣ ΠΑΤΡΩΝ

ΕΡΓΟ

ΜΕΤΑΤΡΟΠΗ ΠΑΛΑΙΟΥ ΔΗΜΟΤΙΚΟΥ ΝΟΣΟΚΟΜΕΙΟΥ
 ΣΕ ΕΚΘΕΣΙΑΚΟ - ΜΟΥΣΕΙΑΚΟ ΧΩΡΟ

ΣΤΑΔΙΟ ΜΕΛΕΤΗΣ

ΣΤΑΤΙΚΗ ΜΕΛΕΤΗ ΕΦΑΡΜΟΓΗΣ

ΘΕΜΑ ΣΧΕΔΙΟΥ

ΣΕΠΤΕΜΒΡΙΟΣ 2010

ΠΡΟΤΑΣΗ ΕΠΕΜΒΑΣΕΩΝ
 ΣΤΑΤΙΚΟΙ ΥΠΟΛΟΓΙΣΜΟΙ - ΤΜΗΜΑ Β

ΚΛΙΜΑΚΑ

ΚΩΔΙΚΟΣ ΕΡΓΟΥ
 Β231-0501

ΜΕΛΕΤΗ ΕΡΓΟΥ

ΑΡΧΙΤΕΚΤΟΝΙΚΗ ΜΕΛΕΤΗ

ΕΙΔΙΚΗ ΑΡΧΙΤΕΚΤΟΝΙΚΗ ΜΕΛΕΤΗ

ΣΤΑΤΙΚΗ ΜΕΛΕΤΗ

Η/Μ ΜΕΛΕΤΗ

ΕΙΔΙΚΟΙ ΣΥΜΒΟΥΛΟΙ

- ΙΩΑΝΝΗΣ ΒΕΝΤΟΥΡΑΚΗΣ
- ΒΕΤΑΓΓΛΑΝ Α.Ε.Μ.
- ΔΟΜΗ Α.Ε.
- TEAM M-H ΕΠ.Ε.
- ΘΩΜΑΣ ΓΡΑΒΑΝΗΣ (ΦΩΤΟΤΕΧΝΙΚΑ)
- ΕΜΜΑΝΟΥΗΛ ΤΖΕΚΑΚΗΣ (ΑΚΟΥΣΤΙΚΗ)
- ΑΛΚΜΗΝΗ ΠΑΚΑ (ΘΕΜΑΤΑ ΠΑΡΟΥΣΙΑΣΗΣ ΕΚΘΕΣΕΩΝ)

ΑΡΙΘΜΟΣ ΤΕΥΧΟΥΣ

T-12

ΚΟΡΓΙΑΛΕΝΙΟΥ 14, 11526 ΑΘΗΝΑ ΤΗΛ. 2106930200 FAX: 210-6930240

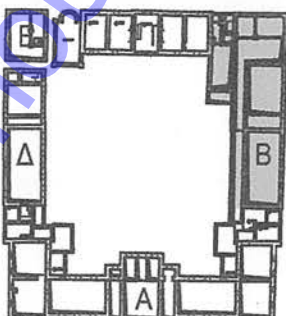

ΥΠΟΓΡΑΦΗ ΚΑΙ ΣΦΡΑΓΙΔΑ ΜΕΛΕΤΗΤΗ

Σ. ΣΤΑΘΟΠΟΥΛΟΣ - Κ. ΦΑΡΡΟΣ
 ΣΥΜΒΟΥΛΟΙ ΜΗΧΑΝΙΚΟΙ ΑΝΩΝΥΜΗ ΕΤΑΙΡΙΑ
 ΚΟΡΓΙΑΛΕΝΙΟΥ 14 - Τ.Κ. 115 26 ΑΘΗΝΑ
 ΑΦΜ: 091146711 - ΤΗΛ: 210 6930200 - ΑΘΗΝΩΝ
 ΑΡ.Μ.Π.Ε. 6664/01/Β/05/471, ΑΦ.Ο.Α.Κ. 676511
 ΤΗΛ. 210.6930200 - FAX: 210.6930240



0003543A7F908851CD669C51C48E7881

Υπουργείο Περιβάλλοντος & Ενέργειας



ΤΜΗΜΑ Β – ΤΕΥΧΟΣ ΣΤΑΤΙΚΩΝ ΥΠΟΛΟΓΙΣΜΩΝ ΠΡΟΤΑΣΗΣ ΕΝΙΣΧΥΣΗΣ

ΠΕΡΙΕΧΟΜΕΝΑ

ΤΡΙΣΔΙΑΣΤΑΤΟ ΠΡΟΣΟΜΟΙΩΜΑ	1
ΔΕΔΟΜΕΝΑ ΧΩΡΙΚΟΥ ΜΟΝΤΕΛΟΥ	6
ΔΙΑΤΟΜΕΣ ΚΑΙ ΥΛΙΚΑ	35
ΦΟΡΤΙΑ	41
ΑΠΟΤΕΛΕΣΜΑΤΑ ΑΝΑΛΥΣΗΣ ΜΕ ΔΕΙΚΤΗ ΕΔΑΦΟΥΣ 3000KN/m^3	45
ΣΥΝΘΗΚΕΣ ΣΤΗΡΙΞΗΣ	46
ΟΡΙΖΟΝΤΙΕΣ ΜΕΤΑΚΙΝΗΣΕΙΣ ΣΕ ΧΑΡΑΚΤΗΡΙΣΤΙΚΕΣ ΘΕΣΕΙΣ	50
ΧΡΩΜΑΤΟΓΡΑΦΙΚΗ ΑΠΕΙΚΟΝΙΣΗ ΤΑΣΕΩΝ	53
ΑΠΟΤΕΛΕΣΜΑΤΑ ΑΝΑΛΥΣΗΣ ΜΕ ΔΕΙΚΤΗ ΕΔΑΦΟΥΣ 20000KN/m^3	84
ΣΥΝΘΗΚΕΣ ΣΤΗΡΙΞΗΣ	85
ΟΡΙΖΟΝΤΙΕΣ ΜΕΤΑΚΙΝΗΣΕΙΣ ΣΕ ΧΑΡΑΚΤΗΡΙΣΤΙΚΕΣ ΘΕΣΕΙΣ	89
ΧΡΩΜΑΤΟΓΡΑΦΙΚΗ ΑΠΕΙΚΟΝΙΣΗ ΤΑΣΕΩΝ	92



ΕΓΚΥΡΟ ΑΝΤΙΓΡΑΦΟ	Α/Α Πράξης: 423334
 0003543A7F90B851CD669C51C48E7881	Ημ/νία έκδοσης πράξης: 07/06/2022 ΕΛΕΓΧΟΣ ΕΓΚΥΡΟΤΗΤΑΣ https://apps.tee.gr/adeiapublic/faces/searchDocFile

Υπουργείο Περιβάλλοντος & Ενέργειας

ΕΡΓΟ : ΜΕΤΑΤΡΟΠΗ ΠΑΛΑΙΟΥ ΔΗΜΟΤΙΚΟΥ ΝΟΣΟΚΟΜΕΙΟΥ ΣΕ ΕΚΘΕΣΙΑΚΟ – ΜΟΥΣΕΙΑΚΟ ΧΩΡΟ

ΠΑΡΑΔΟΧΕΣ

I. ΥΛΙΚΑ

- Οπλισμένο σκυρόδεμα γενικά : C20/25
- Οπλισμένο σκυρόδεμα μηχανοστασίου υποσταθμού ΔΕΗ : C20/25
- Εκτοξευόμενο σκυρόδεμα : C20/25
- Σκυρόδεμα δαπέδων : C20/25
- Άοπλο σκυρόδεμα εξομαλύνσεως (καθαριότητας) : C12/15
- Χάλυβας σκυροδέματος : B500C
- Δομικός χάλυβας : Fe 360
- Δομική ξυλεία : C18
- Αργολιθοδομή σύμφωνα με την παράγραφο 6 της Τεχνικής Έκθεσης.

II. ΦΟΡΤΙΑ

Μόνιμα

- Ίδιον βάρος σκυροδέματος : 25,00 kN/m³
- Ίδιον βάρος αργολιθοδομής : 23,50 kN/m³
- Ίδιον βάρος δομικού χάλυβα : 78,50 kN/m³
- Ίδιον βάρος μπατικών τοίχων : 3,60 kN/m²
- Ίδιον βάρος δρομικών τοίχων : 2,10 kN/m²
- Ίδιον βάρος στέγης + κεραμίδια : 2,10 kN/m²
- Ίδιον βάρος ψευδοροφής : 0,30 kN/m²
- Επικάλυψη δαπέδων : 2,00 kN/m²
- Οροφή μηχανοστασίου : 5,00 kN/m²
- Οροφή υποσταθμού ΔΕΗ : 5,00 kN/m²

Κινητά

- Κινητό δαπέδων γενικά : 5,00 kN/m²
- Κινητό κλιμακοστασίων : 5,00 kN/m²
- Κινητό εξωστών : 5,00 kN/m²
- Κινητό αιθουσών εκθέσεων : 5,00 kN/m²
- Κινητό Η/Μ εγκαταστάσεων πτέρυγα Hansen (εφαρμόζεται στο ενδιάμεσο επίπεδο) : 1,00 kN/m²
- Κινητό στο κάτω πέλμα των ζευκτών εκτός πτέρυγας Hansen (φορτία Η/Μ εγκαταστάσεων) : 1,00 kN/m²





0003543A7908851C0669C51C48E7881

Υπουργείο Περιβάλλοντος & Ενέργειας



- Κινητό οροφής μηχανοστασίου : 5,00 kN/m²
- Κινητό οροφής υποσταθμού ΔΕΗ : 5,00 kN/m²
- Χιόνι : Σύμφωνα με EC1
- Άνεμος : Σύμφωνα με EC1

III. ΣΕΙΣΜΟΣ

Υπολογίζεται βάσει του ΕΑΚ 2000

- Ζώνη σεισμικής επικινδυνότητας : II
- Συντελεστής σπουδαιότητας κτιρίου : α=024
- Συντελεστής σπουδαιότητας κτιρίου : 1,30

IV. ΕΔΑΦΟΣ

Δείκτης εδάφους λαμβάνεται 3000 kN/m³ και 20000 kN/m³, έγιναν δύο επιλύσεις, η διαστασιολόγηση έγινε με τις τιμές της περιβάλλουσας των επιλύσεων.

V. ΠΡΟΒΛΕΨΗ

Δεν γίνεται πρόβλεψη ορόφων.





0003543A7F908851CD669C51C48E7881

Υπουργείο Περιβάλλοντος & Ενέργειας



ΠΕΡΙΓΡΑΦΗ ΑΝΑΛΥΣΗΣ ΤΡΙΣΔΙΑΣΤΑΤΟΥ ΜΟΝΤΕΛΟΥ

Η μοντελοποίηση πραγματοποιήθηκε με το πρόγραμμα στατικής και δυναμικής ανάλυσης EATBS v9.70 της CSI. Το πρόγραμμα αυτό είναι ικανό να αναλύσει πολύπλοκους φορείς με πεπερασμένα και γραμμικά στοιχεία. (Μεμβράνες και κελύφη).

Γενικά

Οι φορείς των κτιρίων είναι κατά κανόνα τοίχοι από αργολιθοδομή, επί των οποίων στηρίζονται ξύλινες στέγες. Οι τοίχοι περιγράφηκαν από πεπερασμένα στοιχεία μεγέθους περίπου 1 x 1m. Τα στοιχεία αυτά έχουν τις ιδιότητες ενός κελύφους. Δηλαδή είναι ικανά να μεταφέρουν τις εσωτερικές δυνάμεις που δρουν όχι μόνο στο επίπεδό τους αλλά και κάθετα στο επίπεδο αυτό. Η στήριξη του κτιρίου αποτελείται από σημειακές στηρίξεις κάθε μία εκ των οποίων είναι δεσμευμένη στις οριζόντιες μετακινήσεις, ελεύθερα στρεπτή και κατά τον κατακόρυφο άξονα δόθηκαν χαρακτηριστικά ελατηρίου, ανάλογα με το δείκτη εδάφους (3000 KN/m³ και 20000 KN/m³).

Στο κτίριο εφαρμόστηκε η ισοδύναμη στατική ανάλυση και δεν εφαρμόστηκε η δυναμική φασματική ανάλυση λόγω του άκαμπτου της κατασκευής.

Πλάκες

Όπου υπήρχαν πλάκες από σκυρόδεμα δόθηκαν οριζόντια πεπερασμένα στοιχεία. Τα στοιχεία αυτά πήραν τα χαρακτηριστικά διαφράγματος. (Η σχετική οριζόντια μετακίνηση στο επίπεδο του διαφράγματος είναι μηδέν).

Στηρίξεις ζευκτών

Τα ζευκτά στηρίζονται πάνω σε σενάζ απο σκυρόδεμα πλάτους, για μεν τους εξωτερικούς τοίχους το πλάτος του τοίχου μείον 0,10÷0,15 m ώστε να επενδυθούν, για δε τους εσωτερικούς τοίχους όλο το πλάτος του τοίχου. Ύψος των σενάζ 0,40 m. Τα σενάζ προσομοιώθηκαν ως γραμμικά μέλη.

Τα ζευκτά δεν περιγράφηκαν στο μοντέλο αλλά δόθηκαν ως γραμμικά φορτία πάνω στα σενάζ.

Τοίχοι

Η ενίσχυση της τοιχοποιίας γίνεται τόσο εσωτερικά όσο και εξωτερικά με οπλισμένο επίχρισμα πάχους 5÷7 cm. Επίσης οι τοίχοι ενισχύονται με ενέματα, με αποτέλεσμα την αύξηση του μέτρου ελαστικότητας της αργολιθοδομής από 4000 MPα σε 7300 MPα.



ΕΓΚΥΡΟ ΑΝΤΙΓΡΑΦΟ	A/A Πράξης: 423334
 0003543A7908851CD669C51C48E7881	Ημ/νία έκδοσης πράξης: 07/06/2022 ΕΛΕΓΧΟΣ ΕΓΚΥΡΟΤΗΤΑΣ https://apps.tee.gr/adeiapublic/faces/searchDocFile

Στη φάση της ενίσχυσης λαμβάνεται $q=1.50$ (συντελεστής συμπεριφοράς) και οι τοίχοι θεωρούνται ρηγματωμένοι· έτσι λοιπόν η δυσκαμψία τους πολλαπλασιάστηκε με συντελεστή 0.60.

Ελεγχος αποτελεσμάτων

Τα αποτελέσματα της ανάλυσης του φορέα αφορούν της μετακινήσεις σημείων πάνω στην ανώτερη στάθμη των τοίχων κατά X και κατά την Y διεύθυνση. Επίσης οι τάσεις των πεπερασμένων στοιχείων στους τοίχους εμφανίζονται ως χρωματογραφικές απεικονίσεις.

ΕΓΚΥΡΟ ΑΝΤΙΓΡΑΦΟ	Α/Α Πράξης: 423334
 0003543A7F908851CD669C51C48E7881	Ημ/νία έκδοσης πράξης: 07/06/2022 ΕΛΕΓΧΟΣ ΕΓΚΥΡΟΤΗΤΑΣ https://apps.tee.gr/adeiapublic/faces/searchDocFile

Υπουργείο Περιβάλλοντος & Ενέργειας

ΤΡΙΣΔΙΑΣΤΑΤΟ ΠΡΟΣΟΜΟΙΩΜΑ





ETABS

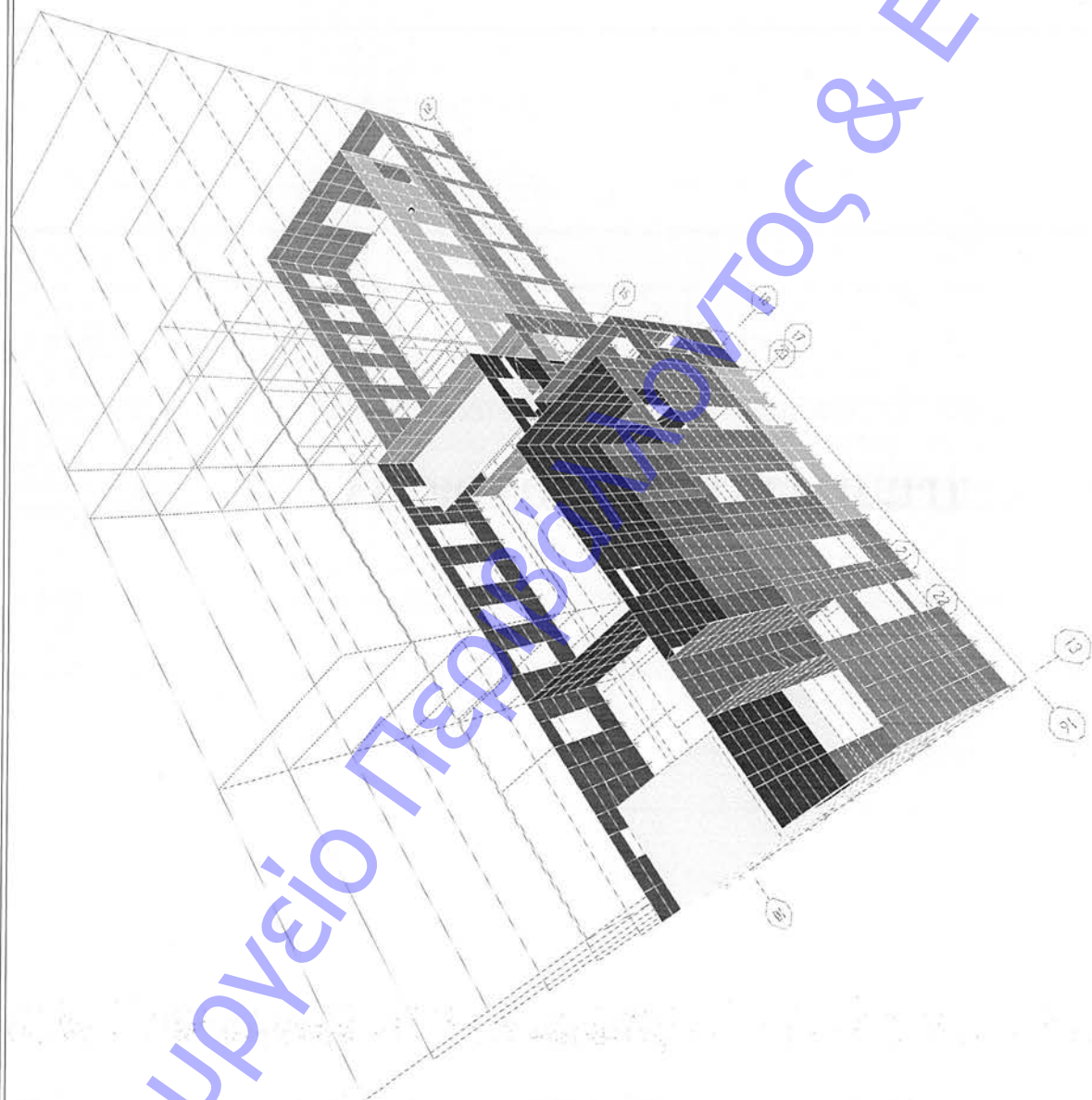



ETABS

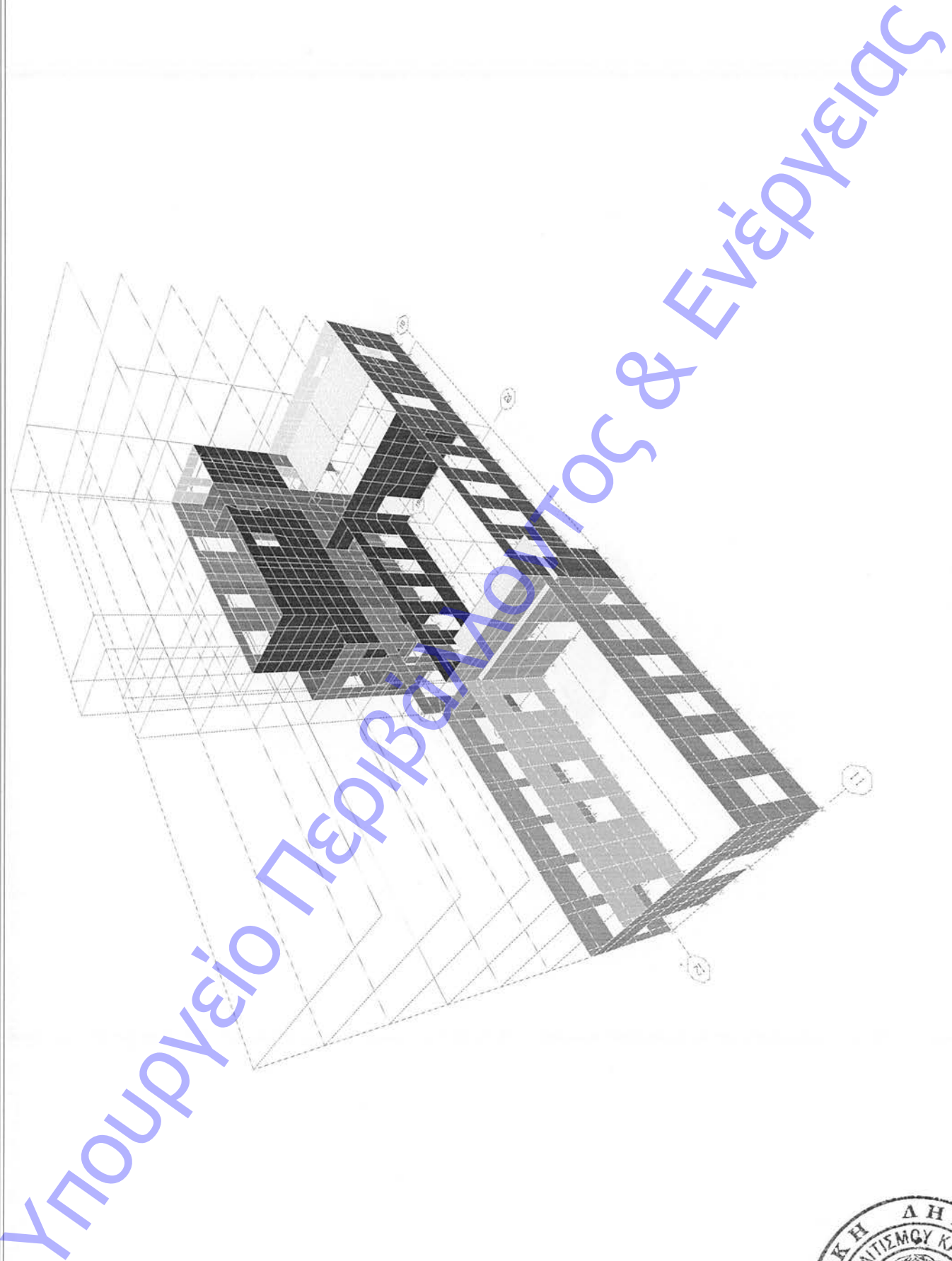



ETABS

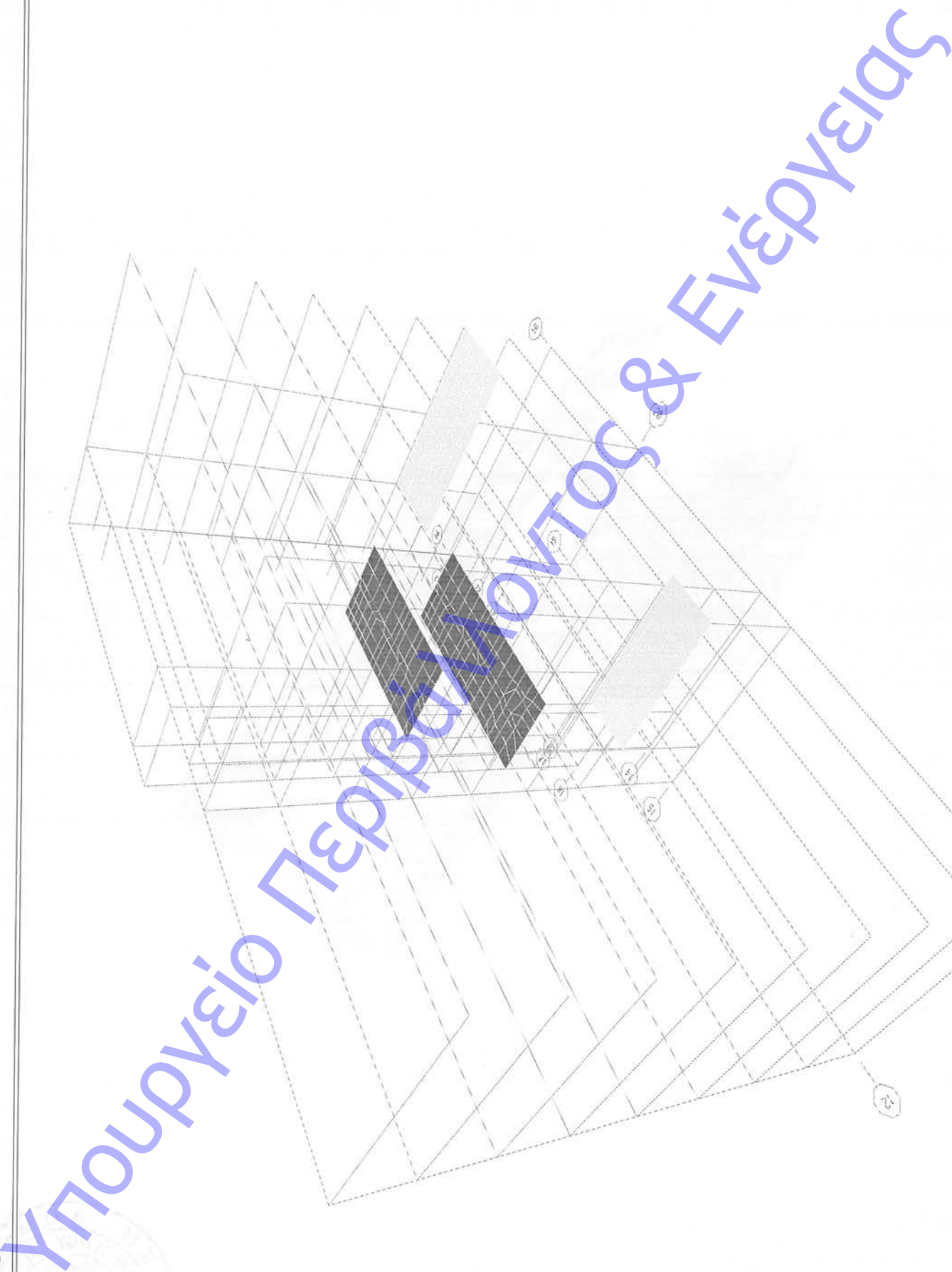



ETABS

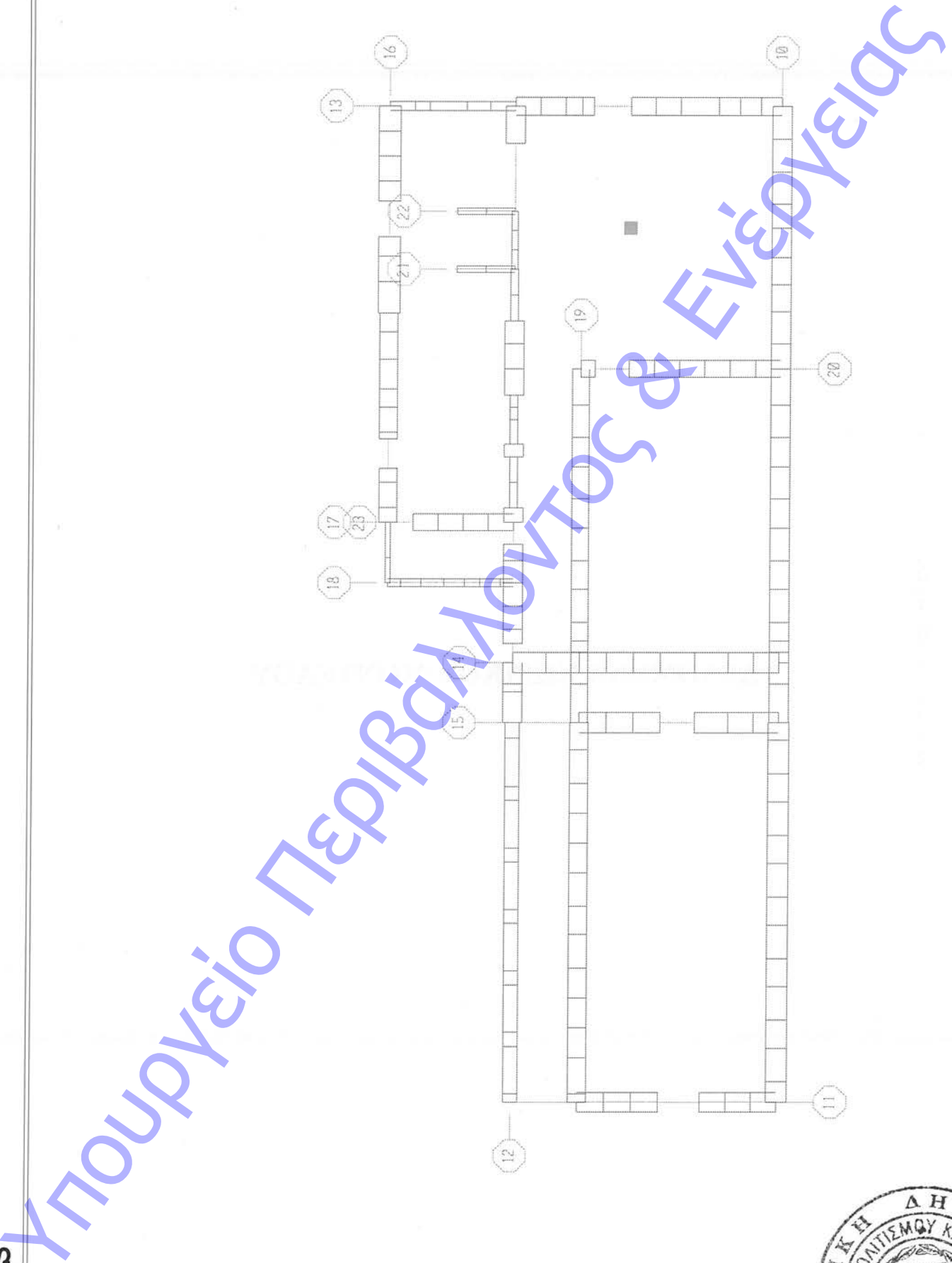

ΕΓΚΥΡΟ ΑΝΤΙΓΡΑΦΟ	Α/Α Πράξης: 423334
 0003543A7F90B851CD669C51C48E7881	Ημ/νία έκδοσης πράξης: 07/06/2022 ΕΛΕΓΧΟΣ ΕΓΚΥΡΟΤΗΤΑΣ https://apps.tee.gr/adeiapublic/faces/searchDocFile

ΔΕΔΟΜΕΝΑ ΧΩΡΙΚΟΥ ΜΟΝΤΕΛΟΥ

M A S S S O U R C E D A T A

MASS	LATERAL	LUMP MASS
FROM	MASS ONLY	AT STORIES
Loads	No	No

M A S S S O U R C E L O A D S

LOAD	MULTIPLIER
DEAD	1.0000
LIVE	0.5000
SELFWEIGHT	1.0000

Υπουργείο Περιβάλλοντος & Ενέργειας



D I A P H R A G M M A S S D A T A

STORY	DIAPHRAGM	MASS-X	MASS-Y	MMI	X-M	Y-M
STORY4	D3	6.590E+01	6.590E+01	9.063E+02	37.184	22.829
STORY2	D1	6.155E+01	6.155E+01	8.549E+02	46.492	15.346
STORY2	D2	4.083E+01	4.083E+01	3.795E+02	26.073	14.130
STORY2	D4	5.878E+01	5.878E+01	9.257E+02	35.817	23.040

Υπουργείο Περιβάλλοντος & Ενέργειας



ASSEMBLED POINT MASSES

STORY	POINT	UX	UY	UZ	RX	RY	RZ
STORY5	66-4	9.657E-01	9.657E-01	9.657E-01	0.000E+00	0.000E+00	0.000E+00
STORY5	67-4	9.720E-01	9.720E-01	9.720E-01	0.000E+00	0.000E+00	0.000E+00
STORY5	68-4	1.234E+00	1.234E+00	1.234E+00	0.000E+00	0.000E+00	0.000E+00
STORY5	69-4	9.283E-01	9.283E-01	9.283E-01	0.000E+00	0.000E+00	0.000E+00
STORY5	70-4	9.034E-01	9.034E-01	9.034E-01	0.000E+00	0.000E+00	0.000E+00
STORY5	71-4	8.936E-01	8.936E-01	8.936E-01	0.000E+00	0.000E+00	0.000E+00
STORY5	72-4	9.348E-01	9.348E-01	9.348E-01	0.000E+00	0.000E+00	0.000E+00
STORY5	73-4	1.064E+00	1.064E+00	1.064E+00	0.000E+00	0.000E+00	0.000E+00
STORY5	74-3	8.343E-01	8.343E-01	8.343E-01	0.000E+00	0.000E+00	0.000E+00
STORY5	76-4	1.038E+00	1.038E+00	1.038E+00	0.000E+00	0.000E+00	0.000E+00
STORY5	77-4	1.153E+00	1.153E+00	1.153E+00	0.000E+00	0.000E+00	0.000E+00
STORY5	78-4	1.121E+00	1.121E+00	1.121E+00	0.000E+00	0.000E+00	0.000E+00
STORY5	79-4	1.038E+00	1.038E+00	1.038E+00	0.000E+00	0.000E+00	0.000E+00
STORY5	80-3	5.137E-01	5.137E-01	5.137E-01	0.000E+00	0.000E+00	0.000E+00
STORY5	82-4	5.919E-01	5.919E-01	5.919E-01	0.000E+00	0.000E+00	0.000E+00
STORY5	83-4	9.453E-01	9.453E-01	9.453E-01	0.000E+00	0.000E+00	0.000E+00
STORY5	84-4	9.346E-01	9.346E-01	9.346E-01	0.000E+00	0.000E+00	0.000E+00
STORY5	85-4	9.346E-01	9.346E-01	9.346E-01	0.000E+00	0.000E+00	0.000E+00
STORY5	86-4	7.165E-01	7.165E-01	7.165E-01	0.000E+00	0.000E+00	0.000E+00
STORY5	66-5	9.927E+00	9.927E+00	9.927E+00	0.000E+00	0.000E+00	0.000E+00
STORY5	67-5	4.860E-01	4.860E-01	4.860E-01	0.000E+00	0.000E+00	0.000E+00
STORY5	68-5	6.168E-01	6.168E-01	6.168E-01	0.000E+00	0.000E+00	0.000E+00
STORY5	69-5	4.642E-01	4.642E-01	4.642E-01	0.000E+00	0.000E+00	0.000E+00
STORY5	70-5	4.517E-01	4.517E-01	4.517E-01	0.000E+00	0.000E+00	0.000E+00
STORY5	71-5	4.468E-01	4.468E-01	4.468E-01	0.000E+00	0.000E+00	0.000E+00
STORY5	72-5	4.674E-01	4.674E-01	4.674E-01	0.000E+00	0.000E+00	0.000E+00
STORY5	73-5	6.961E-01	6.961E-01	6.961E-01	0.000E+00	0.000E+00	0.000E+00
STORY5	74-4	5.811E-01	5.811E-01	5.811E-01	0.000E+00	0.000E+00	0.000E+00
STORY5	76-5	5.188E-01	5.188E-01	5.188E-01	0.000E+00	0.000E+00	0.000E+00
STORY5	77-5	5.763E-01	5.763E-01	5.763E-01	0.000E+00	0.000E+00	0.000E+00
STORY5	78-5	1.002E+01	1.002E+01	1.002E+01	0.000E+00	0.000E+00	0.000E+00
STORY5	79-5	5.815E-01	5.815E-01	5.815E-01	0.000E+00	0.000E+00	0.000E+00
STORY5	81-2	5.921E-01	5.921E-01	5.921E-01	0.000E+00	0.000E+00	0.000E+00
STORY5	81-3	5.764E-01	5.764E-01	5.764E-01	0.000E+00	0.000E+00	0.000E+00
STORY5	82-5	2.959E-01	2.959E-01	2.959E-01	0.000E+00	0.000E+00	0.000E+00
STORY5	83-5	4.726E-01	4.726E-01	4.726E-01	0.000E+00	0.000E+00	0.000E+00
STORY5	84-5	4.673E-01	4.673E-01	4.673E-01	0.000E+00	0.000E+00	0.000E+00
STORY5	85-5	4.673E-01	4.673E-01	4.673E-01	0.000E+00	0.000E+00	0.000E+00
STORY5	86-5	3.583E-01	3.583E-01	3.583E-01	0.000E+00	0.000E+00	0.000E+00
STORY5	163-13	7.788E-01	7.788E-01	7.788E-01	0.000E+00	0.000E+00	0.000E+00
STORY5	165-10	9.159E-01	9.159E-01	9.159E-01	0.000E+00	0.000E+00	0.000E+00
STORY5	166-13	9.159E-01	9.159E-01	9.159E-01	0.000E+00	0.000E+00	0.000E+00
STORY5	167-10	1.053E+00	1.053E+00	1.053E+00	0.000E+00	0.000E+00	0.000E+00
STORY5	168-13	1.208E+00	1.208E+00	1.208E+00	0.000E+00	0.000E+00	0.000E+00
STORY5	153-14	9.753E-01	9.753E-01	9.753E-01	0.000E+00	0.000E+00	0.000E+00
STORY5	163-14	3.355E-01	3.355E-01	3.355E-01	0.000E+00	0.000E+00	0.000E+00
STORY5	165-11	3.721E-01	3.721E-01	3.721E-01	0.000E+00	0.000E+00	0.000E+00
STORY5	166-14	3.721E-01	3.721E-01	3.721E-01	0.000E+00	0.000E+00	0.000E+00
STORY5	167-11	4.278E-01	4.278E-01	4.278E-01	0.000E+00	0.000E+00	0.000E+00
STORY5	168-14	4.961E-01	4.961E-01	4.961E-01	0.000E+00	0.000E+00	0.000E+00
STORY5	153-15	9.881E+00	9.881E+00	9.881E+00	0.000E+00	0.000E+00	0.000E+00
STORY5	169-12	3.824E-01	3.824E-01	3.824E-01	0.000E+00	0.000E+00	0.000E+00
STORY5	170-7	3.824E-01	3.824E-01	3.824E-01	0.000E+00	0.000E+00	0.000E+00
STORY5	169-13	1.912E-01	1.912E-01	1.912E-01	0.000E+00	0.000E+00	0.000E+00
STORY5	170-8	1.912E-01	1.912E-01	1.912E-01	0.000E+00	0.000E+00	0.000E+00
STORY5	171-10	5.736E-01	5.736E-01	5.736E-01	0.000E+00	0.000E+00	0.000E+00
STORY5	172-10	2.868E-01	2.868E-01	2.868E-01	0.000E+00	0.000E+00	0.000E+00
STORY5	171-11	2.868E-01	2.868E-01	2.868E-01	0.000E+00	0.000E+00	0.000E+00
STORY5	172-11	1.434E-01	1.434E-01	1.434E-01	0.000E+00	0.000E+00	0.000E+00
STORY5	173-12	5.736E-01	5.736E-01	5.736E-01	0.000E+00	0.000E+00	0.000E+00
STORY5	174-12	2.868E-01	2.868E-01	2.868E-01	0.000E+00	0.000E+00	0.000E+00
STORY5	173-13	2.868E-01	2.868E-01	2.868E-01	0.000E+00	0.000E+00	0.000E+00
STORY5	174-13	1.434E-01	1.434E-01	1.434E-01	0.000E+00	0.000E+00	0.000E+00
STORY5	142-12	8.762E-01	8.762E-01	8.762E-01	0.000E+00	0.000E+00	0.000E+00
STORY5	143-12	9.931E-01	9.931E-01	9.931E-01	0.000E+00	0.000E+00	0.000E+00
STORY5	144-8	7.759E-01	7.759E-01	7.759E-01	0.000E+00	0.000E+00	0.000E+00
STORY5	146-12	7.857E-01	7.857E-01	7.857E-01	0.000E+00	0.000E+00	0.000E+00
STORY5	155-8	6.996E-01	6.996E-01	6.996E-01	0.000E+00	0.000E+00	0.000E+00
STORY5	147-12	1.140E+00	1.140E+00	1.140E+00	0.000E+00	0.000E+00	0.000E+00
STORY5	148-12	8.080E-01	8.080E-01	8.080E-01	0.000E+00	0.000E+00	0.000E+00
STORY5	152-12	1.048E+00	1.048E+00	1.048E+00	0.000E+00	0.000E+00	0.000E+00
STORY5	150-13	9.671E-01	9.671E-01	9.671E-01	0.000E+00	0.000E+00	0.000E+00
STORY5	142-15	3.797E-01	3.797E-01	3.797E-01	0.000E+00	0.000E+00	0.000E+00
STORY5	143-15	4.303E-01	4.303E-01	4.303E-01	0.000E+00	0.000E+00	0.000E+00
STORY5	144-11	5.149E-01	5.149E-01	5.149E-01	0.000E+00	0.000E+00	0.000E+00
STORY5	146-15	3.405E-01	3.405E-01	3.405E-01	0.000E+00	0.000E+00	0.000E+00
STORY5	155-10	4.819E-01	4.819E-01	4.819E-01	0.000E+00	0.000E+00	0.000E+00
STORY5	147-15	4.942E-01	4.942E-01	4.942E-01	0.000E+00	0.000E+00	0.000E+00
STORY5	148-15	3.605E-01	3.605E-01	3.605E-01	0.000E+00	0.000E+00	0.000E+00
STORY5	150-15	5.195E-01	5.195E-01	5.195E-01	0.000E+00	0.000E+00	0.000E+00
STORY5	154-9	4.950E-01	4.950E-01	4.950E-01	0.000E+00	0.000E+00	0.000E+00
STORY5	154-10	4.950E-01	4.950E-01	4.950E-01	0.000E+00	0.000E+00	0.000E+00
STORY5	152-15	4.542E-01	4.542E-01	4.542E-01	0.000E+00	0.000E+00	0.000E+00
STORY5	149-11	3.359E-01	3.359E-01	3.359E-01	0.000E+00	0.000E+00	0.000E+00
STORY5	149-12	3.359E-01	3.359E-01	3.359E-01	0.000E+00	0.000E+00	0.000E+00
STORY5	176-12	1.491E+00	1.491E+00	1.491E+00	0.000E+00	0.000E+00	0.000E+00
STORY5	177-12	1.061E+00	1.061E+00	1.061E+00	0.000E+00	0.000E+00	0.000E+00





00035437908851C0669C51C48E7881

Ημ/νία έκδοσης πρόξης: 07/06/2022
 ΕΛΕΓΧΟΣ ΕΓΚΥΡΟΤΗΤΑΣ
<https://apps.tee.gr/adeiapublic/faces/searchDocFile>

ETABS v9.7.0 File:ANATOLIKH_PTERYGA_3000_ENISXISI Units:KN-m ΟαδδΥιανήιδ 23, 2010 9:52 PAGE 4

A S S E M B L E D P O I N T M A S S E S

STORY	POINT	UX	UY	UZ	RX	RY	RZ
STORY5	178-12	1.491E+00	1.491E+00	1.491E+00	0.000E+00	0.000E+00	0.000E+00
STORY5	179-12	1.335E+00	1.335E+00	1.335E+00	0.000E+00	0.000E+00	0.000E+00
STORY5	180-12	9.277E-01	9.277E-01	9.277E-01	0.000E+00	0.000E+00	0.000E+00
STORY5	182-12	8.020E-01	8.020E-01	8.020E-01	0.000E+00	0.000E+00	0.000E+00
STORY5	181-12	9.176E-01	9.176E-01	9.176E-01	0.000E+00	0.000E+00	0.000E+00
STORY5	185-8	1.451E+00	1.451E+00	1.451E+00	0.000E+00	0.000E+00	0.000E+00
STORY5	176-15	6.463E-01	6.463E-01	6.463E-01	0.000E+00	0.000E+00	0.000E+00
STORY5	177-15	9.930E+00	9.930E+00	9.930E+00	0.000E+00	0.000E+00	0.000E+00
STORY5	178-15	6.463E-01	6.463E-01	6.463E-01	0.000E+00	0.000E+00	0.000E+00
STORY5	179-15	5.456E-01	5.456E-01	5.456E-01	0.000E+00	0.000E+00	0.000E+00
STORY5	180-15	4.749E-01	4.749E-01	4.749E-01	0.000E+00	0.000E+00	0.000E+00
STORY5	182-15	3.154E-01	3.154E-01	3.154E-01	0.000E+00	0.000E+00	0.000E+00
STORY5	181-15	4.717E-01	4.717E-01	4.717E-01	0.000E+00	0.000E+00	0.000E+00
STORY5	185-11	6.289E-01	6.289E-01	6.289E-01	0.000E+00	0.000E+00	0.000E+00
STORY5	184-8	1.178E+00	1.178E+00	1.178E+00	0.000E+00	0.000E+00	0.000E+00
STORY5	184-11	5.104E-01	5.104E-01	5.104E-01	0.000E+00	0.000E+00	0.000E+00
STORY5	204-3	3.499E-01	3.499E-01	3.499E-01	0.000E+00	0.000E+00	0.000E+00
STORY5	200-14	3.523E-01	3.523E-01	3.523E-01	0.000E+00	0.000E+00	0.000E+00
STORY5	205-3	4.371E-01	4.371E-01	4.371E-01	0.000E+00	0.000E+00	0.000E+00
STORY5	201-14	4.393E-01	4.393E-01	4.393E-01	0.000E+00	0.000E+00	0.000E+00
STORY5	204-4	1.644E-01	1.644E-01	1.644E-01	0.000E+00	0.000E+00	0.000E+00
STORY5	199-13	2.801E-01	2.801E-01	2.801E-01	0.000E+00	0.000E+00	0.000E+00
STORY5	199-14	2.801E-01	2.801E-01	2.801E-01	0.000E+00	0.000E+00	0.000E+00
STORY5	198-13	2.097E-01	2.097E-01	2.097E-01	0.000E+00	0.000E+00	0.000E+00
STORY5	198-14	2.097E-01	2.097E-01	2.097E-01	0.000E+00	0.000E+00	0.000E+00
STORY5	200-15	2.130E-01	2.130E-01	2.130E-01	0.000E+00	0.000E+00	0.000E+00
STORY5	205-4	2.432E-01	2.432E-01	2.432E-01	0.000E+00	0.000E+00	0.000E+00
STORY5	201-15	2.497E-01	2.497E-01	2.497E-01	0.000E+00	0.000E+00	0.000E+00
STORY4	66-1	9.657E-01	9.657E-01	9.657E-01	0.000E+00	0.000E+00	0.000E+00
STORY4	67-1	9.720E-01	9.720E-01	9.720E-01	0.000E+00	0.000E+00	0.000E+00
STORY4	67-2	0.000E+00	0.000E+00	1.258E+00	0.000E+00	0.000E+00	0.000E+00
STORY4	66-2	0.000E+00	0.000E+00	1.319E+00	0.000E+00	0.000E+00	0.000E+00
STORY4	68-1	1.234E+00	1.234E+00	1.234E+00	0.000E+00	0.000E+00	0.000E+00
STORY4	68-2	0.000E+00	0.000E+00	1.603E+00	0.000E+00	0.000E+00	0.000E+00
STORY4	69-1	9.283E-01	9.283E-01	9.283E-01	0.000E+00	0.000E+00	0.000E+00
STORY4	70-1	9.034E-01	9.034E-01	9.034E-01	0.000E+00	0.000E+00	0.000E+00
STORY4	70-2	0.000E+00	0.000E+00	1.174E+00	0.000E+00	0.000E+00	0.000E+00
STORY4	69-2	0.000E+00	0.000E+00	1.206E+00	0.000E+00	0.000E+00	0.000E+00
STORY4	71-1	8.936E-01	8.936E-01	8.936E-01	0.000E+00	0.000E+00	0.000E+00
STORY4	71-2	0.000E+00	0.000E+00	1.161E+00	0.000E+00	0.000E+00	0.000E+00
STORY4	72-1	9.348E-01	9.348E-01	9.348E-01	0.000E+00	0.000E+00	0.000E+00
STORY4	73-1	9.945E-01	9.945E-01	9.945E-01	0.000E+00	0.000E+00	0.000E+00
STORY4	73-2	0.000E+00	0.000E+00	1.647E+00	0.000E+00	0.000E+00	0.000E+00
STORY4	72-2	0.000E+00	0.000E+00	1.214E+00	0.000E+00	0.000E+00	0.000E+00
STORY4	74-1	7.885E-01	7.885E-01	7.885E-01	0.000E+00	0.000E+00	0.000E+00
STORY4	75-1	0.000E+00	0.000E+00	1.510E+00	0.000E+00	0.000E+00	0.000E+00
STORY4	76-1	1.062E+00	1.062E+00	1.062E+00	0.000E+00	0.000E+00	0.000E+00
STORY4	76-2	0.000E+00	0.000E+00	1.510E+00	0.000E+00	0.000E+00	0.000E+00
STORY4	77-1	1.153E+00	1.153E+00	1.153E+00	0.000E+00	0.000E+00	0.000E+00
STORY4	78-1	1.136E+00	1.136E+00	1.136E+00	0.000E+00	0.000E+00	0.000E+00
STORY4	78-2	1.203E+00	1.203E+00	1.203E+00	0.000E+00	0.000E+00	0.000E+00
STORY4	77-2	1.153E+00	1.153E+00	1.153E+00	0.000E+00	0.000E+00	0.000E+00
STORY4	79-1	1.038E+00	1.038E+00	1.038E+00	0.000E+00	0.000E+00	0.000E+00
STORY4	79-2	0.000E+00	0.000E+00	1.577E+00	0.000E+00	0.000E+00	0.000E+00
STORY4	80-1	4.984E-01	4.984E-01	4.984E-01	0.000E+00	0.000E+00	0.000E+00
STORY4	81-1	0.000E+00	0.000E+00	1.329E+00	0.000E+00	0.000E+00	0.000E+00
STORY4	82-1	5.919E-01	5.919E-01	5.919E-01	0.000E+00	0.000E+00	0.000E+00
STORY4	82-2	0.000E+00	0.000E+00	7.690E-01	0.000E+00	0.000E+00	0.000E+00
STORY4	66-3	9.933E-01	9.933E-01	9.933E-01	0.000E+00	0.000E+00	0.000E+00
STORY4	67-3	9.720E-01	9.720E-01	9.720E-01	0.000E+00	0.000E+00	0.000E+00
STORY4	68-3	1.234E+00	1.234E+00	1.234E+00	0.000E+00	0.000E+00	0.000E+00
STORY4	69-3	9.283E-01	9.283E-01	9.283E-01	0.000E+00	0.000E+00	0.000E+00
STORY4	70-3	9.034E-01	9.034E-01	9.034E-01	0.000E+00	0.000E+00	0.000E+00
STORY4	71-3	8.936E-01	8.936E-01	8.936E-01	0.000E+00	0.000E+00	0.000E+00
STORY4	72-3	9.348E-01	9.348E-01	9.348E-01	0.000E+00	0.000E+00	0.000E+00
STORY4	73-3	6.445E-01	6.445E-01	6.445E-01	0.000E+00	0.000E+00	0.000E+00
STORY4	74-2	4.146E-01	4.146E-01	4.146E-01	0.000E+00	0.000E+00	0.000E+00
STORY4	76-3	1.038E+00	1.038E+00	1.038E+00	0.000E+00	0.000E+00	0.000E+00
STORY4	77-3	1.153E+00	1.153E+00	1.153E+00	0.000E+00	0.000E+00	0.000E+00
STORY4	78-3	1.128E+00	1.128E+00	1.128E+00	0.000E+00	0.000E+00	0.000E+00
STORY4	79-3	9.969E-01	9.969E-01	9.969E-01	0.000E+00	0.000E+00	0.000E+00
STORY4	80-2	3.738E-01	3.738E-01	3.738E-01	0.000E+00	0.000E+00	0.000E+00
STORY4	82-3	5.919E-01	5.919E-01	5.919E-01	0.000E+00	0.000E+00	0.000E+00
STORY4	83-1	9.453E-01	9.453E-01	9.453E-01	0.000E+00	0.000E+00	0.000E+00
STORY4	84-1	9.346E-01	9.346E-01	9.346E-01	0.000E+00	0.000E+00	0.000E+00
STORY4	84-2	9.346E-01	9.346E-01	9.346E-01	0.000E+00	0.000E+00	0.000E+00
STORY4	83-2	9.453E-01	9.453E-01	9.453E-01	0.000E+00	0.000E+00	0.000E+00
STORY4	83-3	9.453E-01	9.453E-01	9.453E-01	0.000E+00	0.000E+00	0.000E+00
STORY4	84-3	9.346E-01	9.346E-01	9.346E-01	0.000E+00	0.000E+00	0.000E+00
STORY4	85-1	9.346E-01	9.346E-01	9.346E-01	0.000E+00	0.000E+00	0.000E+00
STORY4	85-2	9.346E-01	9.346E-01	9.346E-01	0.000E+00	0.000E+00	0.000E+00
STORY4	85-3	9.346E-01	9.346E-01	9.346E-01	0.000E+00	0.000E+00	0.000E+00
STORY4	86-1	7.165E-01	7.165E-01	7.165E-01	0.000E+00	0.000E+00	0.000E+00
STORY4	86-2	7.165E-01	7.165E-01	7.165E-01	0.000E+00	0.000E+00	0.000E+00
STORY4	86-3	7.165E-01	7.165E-01	7.165E-01	0.000E+00	0.000E+00	0.000E+00
STORY4	81-4	5.611E-01	5.611E-01	5.611E-01	0.000E+00	0.000E+00	0.000E+00
STORY4	87-3	7.001E-01	7.001E-01	7.001E-01	0.000E+00	0.000E+00	0.000E+00

ASSEMBLED POINT MASSES

STORY	POINT	UX	UY	UZ	RX	RY	RZ
STORY4	88-3	9.638E-01	9.638E-01	9.638E-01	0.000E+00	0.000E+00	0.000E+00
STORY4	89-3	9.581E-01	9.581E-01	9.581E-01	0.000E+00	0.000E+00	0.000E+00
STORY4	66-8	1.542E+00	1.542E+00	1.542E+00	0.000E+00	0.000E+00	0.000E+00
STORY4	67-8	1.002E+00	1.002E+00	1.002E+00	0.000E+00	0.000E+00	0.000E+00
STORY4	68-8	1.272E+00	1.272E+00	1.272E+00	0.000E+00	0.000E+00	0.000E+00
STORY4	69-8	9.574E-01	9.574E-01	9.574E-01	0.000E+00	0.000E+00	0.000E+00
STORY4	70-8	9.316E-01	9.316E-01	9.316E-01	0.000E+00	0.000E+00	0.000E+00
STORY4	71-8	9.215E-01	9.215E-01	9.215E-01	0.000E+00	0.000E+00	0.000E+00
STORY4	72-8	9.640E-01	9.640E-01	9.640E-01	0.000E+00	0.000E+00	0.000E+00
STORY4	73-8	1.288E+00	1.288E+00	1.288E+00	0.000E+00	0.000E+00	0.000E+00
STORY4	75-4	1.199E+00	1.199E+00	1.199E+00	0.000E+00	0.000E+00	0.000E+00
STORY4	76-8	1.218E+00	1.218E+00	1.218E+00	0.000E+00	0.000E+00	0.000E+00
STORY4	77-8	1.189E+00	1.189E+00	1.189E+00	0.000E+00	0.000E+00	0.000E+00
STORY4	78-8	1.271E+00	1.271E+00	1.271E+00	0.000E+00	0.000E+00	0.000E+00
STORY4	79-8	1.285E+00	1.285E+00	1.285E+00	0.000E+00	0.000E+00	0.000E+00
STORY4	81-7	1.135E+00	1.135E+00	1.135E+00	0.000E+00	0.000E+00	0.000E+00
STORY4	82-8	6.104E-01	6.104E-01	6.104E-01	0.000E+00	0.000E+00	0.000E+00
STORY4	87-4	3.395E-01	3.395E-01	3.395E-01	0.000E+00	0.000E+00	0.000E+00
STORY4	88-4	4.673E-01	4.673E-01	4.673E-01	0.000E+00	0.000E+00	0.000E+00
STORY4	89-4	4.645E-01	4.645E-01	4.645E-01	0.000E+00	0.000E+00	0.000E+00
STORY4	83-8	9.748E-01	9.748E-01	9.748E-01	0.000E+00	0.000E+00	0.000E+00
STORY4	84-8	9.638E-01	9.638E-01	9.638E-01	0.000E+00	0.000E+00	0.000E+00
STORY4	85-8	9.638E-01	9.638E-01	9.638E-01	0.000E+00	0.000E+00	0.000E+00
STORY4	86-8	7.389E-01	7.389E-01	7.389E-01	0.000E+00	0.000E+00	0.000E+00
STORY4	163-9	8.031E-01	8.031E-01	8.031E-01	0.000E+00	0.000E+00	0.000E+00
STORY4	165-6	9.445E-01	9.445E-01	9.445E-01	0.000E+00	0.000E+00	0.000E+00
STORY4	166-9	9.445E-01	9.445E-01	9.445E-01	0.000E+00	0.000E+00	0.000E+00
STORY4	167-6	1.086E+00	1.086E+00	1.086E+00	0.000E+00	0.000E+00	0.000E+00
STORY4	168-9	1.259E+00	1.259E+00	1.259E+00	0.000E+00	0.000E+00	0.000E+00
STORY4	153-10	1.177E+00	1.177E+00	1.177E+00	0.000E+00	0.000E+00	0.000E+00
STORY4	163-10	0.000E+00	0.000E+00	9.044E-01	0.000E+00	0.000E+00	0.000E+00
STORY4	165-7	0.000E+00	0.000E+00	1.006E+00	0.000E+00	0.000E+00	0.000E+00
STORY4	166-10	0.000E+00	0.000E+00	1.015E+00	0.000E+00	0.000E+00	0.000E+00
STORY4	167-7	0.000E+00	0.000E+00	1.130E+00	0.000E+00	0.000E+00	0.000E+00
STORY4	168-10	0.000E+00	0.000E+00	1.350E+00	0.000E+00	0.000E+00	0.000E+00
STORY4	153-11	0.000E+00	0.000E+00	1.162E+00	0.000E+00	0.000E+00	0.000E+00
STORY4	163-11	7.788E-01	7.788E-01	7.788E-01	0.000E+00	0.000E+00	0.000E+00
STORY4	165-8	9.159E-01	9.159E-01	9.159E-01	0.000E+00	0.000E+00	0.000E+00
STORY4	166-11	9.159E-01	9.159E-01	9.159E-01	0.000E+00	0.000E+00	0.000E+00
STORY4	167-8	1.053E+00	1.053E+00	1.053E+00	0.000E+00	0.000E+00	0.000E+00
STORY4	168-11	1.234E+00	1.234E+00	1.234E+00	0.000E+00	0.000E+00	0.000E+00
STORY4	153-12	1.078E+00	1.078E+00	1.078E+00	0.000E+00	0.000E+00	0.000E+00
STORY4	163-12	8.567E-01	8.567E-01	8.567E-01	0.000E+00	0.000E+00	0.000E+00
STORY4	165-9	1.040E+00	1.040E+00	1.040E+00	0.000E+00	0.000E+00	0.000E+00
STORY4	166-12	1.040E+00	1.040E+00	1.040E+00	0.000E+00	0.000E+00	0.000E+00
STORY4	167-9	1.196E+00	1.196E+00	1.196E+00	0.000E+00	0.000E+00	0.000E+00
STORY4	168-12	1.387E+00	1.387E+00	1.387E+00	0.000E+00	0.000E+00	0.000E+00
STORY4	153-13	1.166E+00	1.166E+00	1.166E+00	0.000E+00	0.000E+00	0.000E+00
STORY4	169-8	3.943E-01	3.943E-01	3.943E-01	0.000E+00	0.000E+00	0.000E+00
STORY4	169-9	3.824E-01	3.824E-01	3.824E-01	0.000E+00	0.000E+00	0.000E+00
STORY4	170-3	3.943E-01	3.943E-01	3.943E-01	0.000E+00	0.000E+00	0.000E+00
STORY4	170-4	3.824E-01	3.824E-01	3.824E-01	0.000E+00	0.000E+00	0.000E+00
STORY4	169-10	3.824E-01	3.824E-01	3.824E-01	0.000E+00	0.000E+00	0.000E+00
STORY4	170-5	3.824E-01	3.824E-01	3.824E-01	0.000E+00	0.000E+00	0.000E+00
STORY4	169-11	3.824E-01	3.824E-01	3.824E-01	0.000E+00	0.000E+00	0.000E+00
STORY4	170-6	3.824E-01	3.824E-01	3.824E-01	0.000E+00	0.000E+00	0.000E+00
STORY4	171-6	5.915E-01	5.915E-01	5.915E-01	0.000E+00	0.000E+00	0.000E+00
STORY4	172-6	2.958E-01	2.958E-01	2.958E-01	0.000E+00	0.000E+00	0.000E+00
STORY4	171-7	5.736E-01	5.736E-01	5.736E-01	0.000E+00	0.000E+00	0.000E+00
STORY4	172-7	2.868E-01	2.868E-01	2.868E-01	0.000E+00	0.000E+00	0.000E+00
STORY4	171-8	5.736E-01	5.736E-01	5.736E-01	0.000E+00	0.000E+00	0.000E+00
STORY4	172-8	2.868E-01	2.868E-01	2.868E-01	0.000E+00	0.000E+00	0.000E+00
STORY4	171-9	5.736E-01	5.736E-01	5.736E-01	0.000E+00	0.000E+00	0.000E+00
STORY4	172-9	2.868E-01	2.868E-01	2.868E-01	0.000E+00	0.000E+00	0.000E+00
STORY4	173-8	5.915E-01	5.915E-01	5.915E-01	0.000E+00	0.000E+00	0.000E+00
STORY4	174-8	2.958E-01	2.958E-01	2.958E-01	0.000E+00	0.000E+00	0.000E+00
STORY4	173-9	0.000E+00	0.000E+00	9.464E-01	0.000E+00	0.000E+00	0.000E+00
STORY4	174-9	0.000E+00	0.000E+00	5.598E-01	0.000E+00	0.000E+00	0.000E+00
STORY4	173-10	5.736E-01	5.736E-01	5.736E-01	0.000E+00	0.000E+00	0.000E+00
STORY4	174-10	2.868E-01	2.868E-01	2.868E-01	0.000E+00	0.000E+00	0.000E+00
STORY4	173-11	5.736E-01	5.736E-01	5.736E-01	0.000E+00	0.000E+00	0.000E+00
STORY4	81-14	4.780E-01	4.780E-01	4.780E-01	0.000E+00	0.000E+00	0.000E+00
STORY4	174-11	2.868E-01	2.868E-01	2.868E-01	0.000E+00	0.000E+00	0.000E+00
STORY4	142-10	9.638E-01	9.638E-01	9.638E-01	0.000E+00	0.000E+00	0.000E+00
STORY4	143-10	1.092E+00	1.092E+00	1.092E+00	0.000E+00	0.000E+00	0.000E+00
STORY4	144-6	1.307E+00	1.307E+00	1.307E+00	0.000E+00	0.000E+00	0.000E+00
STORY4	146-10	8.643E-01	8.643E-01	8.643E-01	0.000E+00	0.000E+00	0.000E+00
STORY4	155-5	1.223E+00	1.223E+00	1.223E+00	0.000E+00	0.000E+00	0.000E+00
STORY4	147-10	1.254E+00	1.254E+00	1.254E+00	0.000E+00	0.000E+00	0.000E+00
STORY4	148-10	9.150E-01	9.150E-01	9.150E-01	0.000E+00	0.000E+00	0.000E+00
STORY4	149-7	8.526E-01	8.526E-01	8.526E-01	0.000E+00	0.000E+00	0.000E+00
STORY4	150-10	1.319E+00	1.319E+00	1.319E+00	0.000E+00	0.000E+00	0.000E+00
STORY4	154-6	1.256E+00	1.256E+00	1.256E+00	0.000E+00	0.000E+00	0.000E+00
STORY4	152-10	1.153E+00	1.153E+00	1.153E+00	0.000E+00	0.000E+00	0.000E+00
STORY4	142-11	0.000E+00	0.000E+00	1.003E+00	0.000E+00	0.000E+00	0.000E+00
STORY4	143-11	0.000E+00	0.000E+00	1.130E+00	0.000E+00	0.000E+00	0.000E+00
STORY4	144-7	0.000E+00	0.000E+00	1.361E+00	0.000E+00	0.000E+00	0.000E+00



A S S E M B L E D P O I N T M A S S E S

STORY	POINT	UX	UY	UZ	RX	RY	RZ
STORY4	146-11	0.000E+00	0.000E+00	8.998E-01	0.000E+00	0.000E+00	0.000E+00
STORY4	155-6	0.000E+00	0.000E+00	1.273E+00	0.000E+00	0.000E+00	0.000E+00
STORY4	147-11	0.000E+00	0.000E+00	1.306E+00	0.000E+00	0.000E+00	0.000E+00
STORY4	148-11	0.000E+00	0.000E+00	9.526E-01	0.000E+00	0.000E+00	0.000E+00
STORY4	149-9	0.000E+00	0.000E+00	8.876E-01	0.000E+00	0.000E+00	0.000E+00
STORY4	150-11	0.000E+00	0.000E+00	1.373E+00	0.000E+00	0.000E+00	0.000E+00
STORY4	154-7	0.000E+00	0.000E+00	1.308E+00	0.000E+00	0.000E+00	0.000E+00
STORY4	152-11	0.000E+00	0.000E+00	1.184E+00	0.000E+00	0.000E+00	0.000E+00
STORY4	143-13	1.203E+00	1.203E+00	1.203E+00	0.000E+00	0.000E+00	0.000E+00
STORY4	142-13	1.061E+00	1.061E+00	1.061E+00	0.000E+00	0.000E+00	0.000E+00
STORY4	143-14	1.126E+00	1.126E+00	1.126E+00	0.000E+00	0.000E+00	0.000E+00
STORY4	142-14	9.930E-01	9.930E-01	9.930E-01	0.000E+00	0.000E+00	0.000E+00
STORY4	144-9	4.597E-01	4.597E-01	4.597E-01	0.000E+00	0.000E+00	0.000E+00
STORY4	144-10	8.256E-01	8.256E-01	8.256E-01	0.000E+00	0.000E+00	0.000E+00
STORY4	155-9	3.673E-01	3.673E-01	3.673E-01	0.000E+00	0.000E+00	0.000E+00
STORY4	146-13	9.516E-01	9.516E-01	9.516E-01	0.000E+00	0.000E+00	0.000E+00
STORY4	147-13	1.381E+00	1.381E+00	1.381E+00	0.000E+00	0.000E+00	0.000E+00
STORY4	146-14	8.905E-01	8.905E-01	8.905E-01	0.000E+00	0.000E+00	0.000E+00
STORY4	147-14	1.292E+00	1.292E+00	1.292E+00	0.000E+00	0.000E+00	0.000E+00
STORY4	148-13	7.969E-01	7.969E-01	7.969E-01	0.000E+00	0.000E+00	0.000E+00
STORY4	148-14	8.307E-01	8.307E-01	8.307E-01	0.000E+00	0.000E+00	0.000E+00
STORY4	150-12	1.010E+00	1.010E+00	1.010E+00	0.000E+00	0.000E+00	0.000E+00
STORY4	154-8	5.584E-01	5.584E-01	5.584E-01	0.000E+00	0.000E+00	0.000E+00
STORY4	150-14	7.969E-01	7.969E-01	7.969E-01	0.000E+00	0.000E+00	0.000E+00
STORY4	152-13	1.269E+00	1.269E+00	1.269E+00	0.000E+00	0.000E+00	0.000E+00
STORY4	152-14	1.188E+00	1.188E+00	1.188E+00	0.000E+00	0.000E+00	0.000E+00
STORY4	149-10	3.789E-01	3.789E-01	3.789E-01	0.000E+00	0.000E+00	0.000E+00
STORY4	155-11	7.391E-01	7.391E-01	7.391E-01	0.000E+00	0.000E+00	0.000E+00
STORY4	176-10	1.641E+00	1.641E+00	1.641E+00	0.000E+00	0.000E+00	0.000E+00
STORY4	177-10	1.159E+00	1.159E+00	1.159E+00	0.000E+00	0.000E+00	0.000E+00
STORY4	178-10	1.641E+00	1.641E+00	1.641E+00	0.000E+00	0.000E+00	0.000E+00
STORY4	179-10	1.468E+00	1.468E+00	1.468E+00	0.000E+00	0.000E+00	0.000E+00
STORY4	180-10	1.824E+00	1.824E+00	1.824E+00	0.000E+00	0.000E+00	0.000E+00
STORY4	181-10	1.813E+00	1.813E+00	1.813E+00	0.000E+00	0.000E+00	0.000E+00
STORY4	182-10	8.822E-01	8.822E-01	8.822E-01	0.000E+00	0.000E+00	0.000E+00
STORY4	184-2	1.092E+00	1.092E+00	1.092E+00	0.000E+00	0.000E+00	0.000E+00
STORY4	185-6	1.318E+00	1.318E+00	1.318E+00	0.000E+00	0.000E+00	0.000E+00
STORY4	176-11	1.525E+00	1.525E+00	1.525E+00	0.000E+00	0.000E+00	0.000E+00
STORY4	177-11	1.072E+00	1.072E+00	1.072E+00	0.000E+00	0.000E+00	0.000E+00
STORY4	178-11	1.525E+00	1.525E+00	1.525E+00	0.000E+00	0.000E+00	0.000E+00
STORY4	179-11	1.364E+00	1.364E+00	1.364E+00	0.000E+00	0.000E+00	0.000E+00
STORY4	180-11	1.172E+00	1.172E+00	1.172E+00	0.000E+00	0.000E+00	0.000E+00
STORY4	181-11	1.162E+00	1.162E+00	1.162E+00	0.000E+00	0.000E+00	0.000E+00
STORY4	182-11	8.198E-01	8.198E-01	8.198E-01	0.000E+00	0.000E+00	0.000E+00
STORY4	184-4	3.322E-01	3.322E-01	3.322E-01	0.000E+00	0.000E+00	0.000E+00
STORY4	185-7	0.000E+00	0.000E+00	1.050E+00	0.000E+00	0.000E+00	0.000E+00
STORY4	177-13	1.272E+00	1.272E+00	1.272E+00	0.000E+00	0.000E+00	0.000E+00
STORY4	176-13	1.806E+00	1.806E+00	1.806E+00	0.000E+00	0.000E+00	0.000E+00
STORY4	177-14	1.188E+00	1.188E+00	1.188E+00	0.000E+00	0.000E+00	0.000E+00
STORY4	176-14	1.690E+00	1.690E+00	1.690E+00	0.000E+00	0.000E+00	0.000E+00
STORY4	178-13	1.806E+00	1.806E+00	1.806E+00	0.000E+00	0.000E+00	0.000E+00
STORY4	178-14	1.690E+00	1.690E+00	1.690E+00	0.000E+00	0.000E+00	0.000E+00
STORY4	179-13	1.649E+00	1.649E+00	1.649E+00	0.000E+00	0.000E+00	0.000E+00
STORY4	179-14	1.513E+00	1.513E+00	1.513E+00	0.000E+00	0.000E+00	0.000E+00
STORY4	180-13	7.787E-01	7.787E-01	7.787E-01	0.000E+00	0.000E+00	0.000E+00
STORY4	180-14	6.675E-01	6.675E-01	6.675E-01	0.000E+00	0.000E+00	0.000E+00
STORY4	181-13	7.654E-01	7.654E-01	7.654E-01	0.000E+00	0.000E+00	0.000E+00
STORY4	182-13	1.003E+00	1.003E+00	1.003E+00	0.000E+00	0.000E+00	0.000E+00
STORY4	181-14	6.561E-01	6.561E-01	6.561E-01	0.000E+00	0.000E+00	0.000E+00
STORY4	182-14	9.090E-01	9.090E-01	9.090E-01	0.000E+00	0.000E+00	0.000E+00
STORY4	185-9	1.758E+00	1.758E+00	1.758E+00	0.000E+00	0.000E+00	0.000E+00
STORY4	185-10	1.389E+00	1.389E+00	1.389E+00	0.000E+00	0.000E+00	0.000E+00
STORY4	184-9	1.427E+00	1.427E+00	1.427E+00	0.000E+00	0.000E+00	0.000E+00
STORY4	184-10	1.149E+00	1.149E+00	1.149E+00	0.000E+00	0.000E+00	0.000E+00
STORY4	188-5	3.559E-01	3.559E-01	3.559E-01	0.000E+00	0.000E+00	0.000E+00
STORY4	187-10	2.570E-01	2.570E-01	2.570E-01	0.000E+00	0.000E+00	0.000E+00
STORY4	189-5	3.460E-01	3.460E-01	3.460E-01	0.000E+00	0.000E+00	0.000E+00
STORY4	188-6	1.725E-01	1.725E-01	1.725E-01	0.000E+00	0.000E+00	0.000E+00
STORY4	187-11	1.246E-01	1.246E-01	1.246E-01	0.000E+00	0.000E+00	0.000E+00
STORY4	189-6	1.677E-01	1.677E-01	1.677E-01	0.000E+00	0.000E+00	0.000E+00
STORY4	190-10	3.855E-01	3.855E-01	3.855E-01	0.000E+00	0.000E+00	0.000E+00
STORY4	196-6	5.783E-01	5.783E-01	5.783E-01	0.000E+00	0.000E+00	0.000E+00
STORY4	197-6	5.783E-01	5.783E-01	5.783E-01	0.000E+00	0.000E+00	0.000E+00
STORY4	193-10	3.114E-01	3.114E-01	3.114E-01	0.000E+00	0.000E+00	0.000E+00
STORY4	194-10	3.410E-01	3.410E-01	3.410E-01	0.000E+00	0.000E+00	0.000E+00
STORY4	195-10	4.152E-01	4.152E-01	4.152E-01	0.000E+00	0.000E+00	0.000E+00
STORY4	190-11	1.869E-01	1.869E-01	1.869E-01	0.000E+00	0.000E+00	0.000E+00
STORY4	196-7	2.804E-01	2.804E-01	2.804E-01	0.000E+00	0.000E+00	0.000E+00
STORY4	197-7	2.804E-01	2.804E-01	2.804E-01	0.000E+00	0.000E+00	0.000E+00
STORY4	193-11	1.510E-01	1.510E-01	1.510E-01	0.000E+00	0.000E+00	0.000E+00
STORY4	194-11	1.653E-01	1.653E-01	1.653E-01	0.000E+00	0.000E+00	0.000E+00
STORY4	195-11	2.013E-01	2.013E-01	2.013E-01	0.000E+00	0.000E+00	0.000E+00
STORY4	198-10	6.573E-01	6.573E-01	6.573E-01	0.000E+00	0.000E+00	0.000E+00
STORY4	199-10	8.200E-01	8.200E-01	8.200E-01	0.000E+00	0.000E+00	0.000E+00
STORY4	200-10	6.989E-01	6.989E-01	6.989E-01	0.000E+00	0.000E+00	0.000E+00
STORY4	201-10	5.363E-01	5.363E-01	5.363E-01	0.000E+00	0.000E+00	0.000E+00
STORY4	198-11	5.995E-01	5.995E-01	5.995E-01	0.000E+00	0.000E+00	0.000E+00

ASSEMBLED POINT MASSES

STORY	POINT	UX	UY	UZ	RX	RY	RZ
STORY4	199-11	7.546E-01	7.546E-01	7.546E-01	0.000E+00	0.000E+00	0.000E+00
STORY4	200-11	5.801E-01	5.801E-01	5.801E-01	0.000E+00	0.000E+00	0.000E+00
STORY4	201-11	4.770E-01	4.770E-01	4.770E-01	0.000E+00	0.000E+00	0.000E+00
STORY4	204-1	2.596E-01	2.596E-01	2.596E-01	0.000E+00	0.000E+00	0.000E+00
STORY4	199-12	1.935E-01	1.935E-01	1.935E-01	0.000E+00	0.000E+00	0.000E+00
STORY4	198-12	1.554E-01	1.554E-01	1.554E-01	0.000E+00	0.000E+00	0.000E+00
STORY4	200-12	3.466E-01	3.466E-01	3.466E-01	0.000E+00	0.000E+00	0.000E+00
STORY4	205-1	3.371E-01	3.371E-01	3.371E-01	0.000E+00	0.000E+00	0.000E+00
STORY4	201-12	4.133E-01	4.133E-01	4.133E-01	0.000E+00	0.000E+00	0.000E+00
STORY4	204-2	2.317E-01	2.317E-01	2.317E-01	0.000E+00	0.000E+00	0.000E+00
STORY4	200-13	2.569E-01	2.569E-01	2.569E-01	0.000E+00	0.000E+00	0.000E+00
STORY4	205-2	2.569E-01	2.569E-01	2.569E-01	0.000E+00	0.000E+00	0.000E+00
STORY4	201-13	3.642E-01	3.642E-01	3.642E-01	0.000E+00	0.000E+00	0.000E+00
STORY4	318-2	0.000E+00	0.000E+00	3.248E-01	0.000E+00	0.000E+00	0.000E+00
STORY4	319-2	0.000E+00	0.000E+00	3.832E-01	0.000E+00	0.000E+00	0.000E+00
STORY4	320-2	0.000E+00	0.000E+00	3.651E-01	0.000E+00	0.000E+00	0.000E+00
STORY4	321-2	0.000E+00	0.000E+00	2.477E-01	0.000E+00	0.000E+00	0.000E+00
STORY4	322-2	0.000E+00	0.000E+00	2.659E-01	0.000E+00	0.000E+00	0.000E+00
STORY4	323-2	0.000E+00	0.000E+00	3.645E-01	0.000E+00	0.000E+00	0.000E+00
STORY4	324-2	0.000E+00	0.000E+00	2.511E-01	0.000E+00	0.000E+00	0.000E+00
STORY4	325-2	0.000E+00	0.000E+00	3.554E-01	0.000E+00	0.000E+00	0.000E+00
STORY4	326-2	0.000E+00	0.000E+00	3.798E-01	0.000E+00	0.000E+00	0.000E+00
STORY4	327-2	0.000E+00	0.000E+00	2.800E-01	0.000E+00	0.000E+00	0.000E+00
STORY4	328-2	0.000E+00	0.000E+00	2.987E-01	0.000E+00	0.000E+00	0.000E+00
STORY4	329-2	0.000E+00	0.000E+00	2.619E-01	0.000E+00	0.000E+00	0.000E+00
STORY4	183-6	0.000E+00	0.000E+00	9.589E-01	0.000E+00	0.000E+00	0.000E+00
STORY4	330-2	0.000E+00	0.000E+00	2.262E-01	0.000E+00	0.000E+00	0.000E+00
STORY4	331-2	0.000E+00	0.000E+00	3.425E-01	0.000E+00	0.000E+00	0.000E+00
STORY4	332-2	0.000E+00	0.000E+00	2.933E-01	0.000E+00	0.000E+00	0.000E+00
STORY4	333-2	0.000E+00	0.000E+00	2.915E-01	0.000E+00	0.000E+00	0.000E+00
STORY4	334-2	0.000E+00	0.000E+00	2.262E-01	0.000E+00	0.000E+00	0.000E+00
STORY4	335-2	0.000E+00	0.000E+00	5.025E-01	0.000E+00	0.000E+00	0.000E+00
STORY4	336-2	0.000E+00	0.000E+00	3.932E-01	0.000E+00	0.000E+00	0.000E+00
STORY4	337-2	0.000E+00	0.000E+00	3.303E-01	0.000E+00	0.000E+00	0.000E+00
STORY4	338-2	0.000E+00	0.000E+00	4.832E-01	0.000E+00	0.000E+00	0.000E+00
STORY4	339-2	0.000E+00	0.000E+00	4.464E-01	0.000E+00	0.000E+00	0.000E+00
STORY4	340-2	0.000E+00	0.000E+00	5.011E-01	0.000E+00	0.000E+00	0.000E+00
STORY4	341-2	0.000E+00	0.000E+00	4.774E-01	0.000E+00	0.000E+00	0.000E+00
STORY4	342-2	0.000E+00	0.000E+00	3.240E-01	0.000E+00	0.000E+00	0.000E+00
STORY4	343-2	0.000E+00	0.000E+00	3.477E-01	0.000E+00	0.000E+00	0.000E+00
STORY4	344-2	0.000E+00	0.000E+00	4.767E-01	0.000E+00	0.000E+00	0.000E+00
STORY4	345-2	0.000E+00	0.000E+00	3.284E-01	0.000E+00	0.000E+00	0.000E+00
STORY4	346-2	0.000E+00	0.000E+00	4.648E-01	0.000E+00	0.000E+00	0.000E+00
STORY4	347-2	0.000E+00	0.000E+00	4.967E-01	0.000E+00	0.000E+00	0.000E+00
STORY4	348-2	0.000E+00	0.000E+00	3.662E-01	0.000E+00	0.000E+00	0.000E+00
STORY4	350-2	0.000E+00	0.000E+00	3.521E-01	0.000E+00	0.000E+00	0.000E+00
STORY4	351-2	0.000E+00	0.000E+00	4.029E-01	0.000E+00	0.000E+00	0.000E+00
STORY4	352-2	0.000E+00	0.000E+00	3.740E-01	0.000E+00	0.000E+00	0.000E+00
STORY4	353-2	0.000E+00	0.000E+00	2.647E-01	0.000E+00	0.000E+00	0.000E+00
STORY4	354-2	0.000E+00	0.000E+00	2.811E-01	0.000E+00	0.000E+00	0.000E+00
STORY4	355-2	0.000E+00	0.000E+00	3.601E-01	0.000E+00	0.000E+00	0.000E+00
STORY4	356-2	0.000E+00	0.000E+00	2.691E-01	0.000E+00	0.000E+00	0.000E+00
STORY4	357-2	0.000E+00	0.000E+00	3.538E-01	0.000E+00	0.000E+00	0.000E+00
STORY4	358-2	0.000E+00	0.000E+00	3.747E-01	0.000E+00	0.000E+00	0.000E+00
STORY4	359-2	0.000E+00	0.000E+00	3.049E-01	0.000E+00	0.000E+00	0.000E+00
STORY4	361-2	0.000E+00	0.000E+00	4.571E-01	0.000E+00	0.000E+00	0.000E+00
STORY4	362-2	0.000E+00	0.000E+00	5.118E-01	0.000E+00	0.000E+00	0.000E+00
STORY4	363-2	0.000E+00	0.000E+00	3.940E-01	0.000E+00	0.000E+00	0.000E+00
STORY4	364-2	0.000E+00	0.000E+00	3.710E-01	0.000E+00	0.000E+00	0.000E+00
STORY4	365-2	0.000E+00	0.000E+00	3.693E-01	0.000E+00	0.000E+00	0.000E+00
STORY4	366-2	0.000E+00	0.000E+00	2.664E-01	0.000E+00	0.000E+00	0.000E+00
STORY4	367-2	0.000E+00	0.000E+00	3.832E-01	0.000E+00	0.000E+00	0.000E+00
STORY4	368-2	0.000E+00	0.000E+00	5.582E-01	0.000E+00	0.000E+00	0.000E+00
STORY4	369-2	0.000E+00	0.000E+00	4.728E-01	0.000E+00	0.000E+00	0.000E+00
STORY4	373-2	0.000E+00	0.000E+00	5.744E-01	0.000E+00	0.000E+00	0.000E+00
STORY4	374-2	0.000E+00	0.000E+00	1.043E-01	0.000E+00	0.000E+00	0.000E+00
STORY4	375-2	0.000E+00	0.000E+00	1.364E-01	0.000E+00	0.000E+00	0.000E+00
STORY4	376-2	0.000E+00	0.000E+00	9.628E-02	0.000E+00	0.000E+00	0.000E+00
STORY4	377-2	0.000E+00	0.000E+00	7.457E-01	0.000E+00	0.000E+00	0.000E+00
STORY4	378-2	0.000E+00	0.000E+00	7.066E-01	0.000E+00	0.000E+00	0.000E+00
STORY4	379-2	0.000E+00	0.000E+00	6.955E-01	0.000E+00	0.000E+00	0.000E+00
STORY4	380-2	0.000E+00	0.000E+00	7.474E-01	0.000E+00	0.000E+00	0.000E+00
STORY4	381-2	0.000E+00	0.000E+00	5.594E-01	0.000E+00	0.000E+00	0.000E+00
STORY4	382-2	0.000E+00	0.000E+00	3.542E-01	0.000E+00	0.000E+00	0.000E+00
STORY4	383-2	0.000E+00	0.000E+00	5.347E-01	0.000E+00	0.000E+00	0.000E+00
STORY4	384-2	0.000E+00	0.000E+00	5.406E-01	0.000E+00	0.000E+00	0.000E+00
STORY4	385-2	0.000E+00	0.000E+00	5.555E-01	0.000E+00	0.000E+00	0.000E+00
STORY4	386-2	0.000E+00	0.000E+00	7.382E-01	0.000E+00	0.000E+00	0.000E+00
STORY4	387-2	0.000E+00	0.000E+00	5.501E-01	0.000E+00	0.000E+00	0.000E+00
STORY4	183-7	4.419E-01	4.419E-01	4.419E-01	0.000E+00	0.000E+00	0.000E+00
STORY4	183-8	4.821E-01	4.821E-01	4.821E-01	0.000E+00	0.000E+00	0.000E+00
STORY4	393-1	6.590E+01	6.590E+01	0.000E+00	0.000E+00	0.000E+00	9.063E+02
STORY3	1-6	5.896E-01	5.896E-01	5.896E-01	0.000E+00	0.000E+00	0.000E+00
STORY3	2-6	1.671E+01	1.671E+01	1.671E+01	0.000E+00	0.000E+00	0.000E+00
STORY3	4-6	6.766E-01	6.766E-01	6.766E-01	0.000E+00	0.000E+00	0.000E+00
STORY3	3-6	1.591E+01	1.591E+01	1.591E+01	0.000E+00	0.000E+00	0.000E+00
STORY3	5-6	6.551E-01	6.551E-01	6.551E-01	0.000E+00	0.000E+00	0.000E+00





0003543A7F908851CD669C51C48E7881

Ημ/νία έκδοσης πρόξης: 07/06/2022
 ΕΛΕΓΧΟΣ ΕΓΚΥΡΟΤΗΤΑΣ
<https://apps.tee.gr/adeiapublic/faces/searchDocFile>

ETABS v9.7.0 File:ANATOLIKH_PTERYGA_3000_ENISXISI Units:KN-m ΟάδδΥιάνειδ 23, 2010 9:52 PAGE 8

A S S E M B L E D P O I N T M A S S E S

STORY	POINT	UX	UY	UZ	RX	RY	RZ
STORY3	6-6	6.524E-01	6.524E-01	6.524E-01	0.000E+00	0.000E+00	0.000E+00
STORY3	7-6	1.586E+00	1.586E+00	1.586E+00	0.000E+00	0.000E+00	0.000E+00
STORY3	8-6	6.524E-01	6.524E-01	6.524E-01	0.000E+00	0.000E+00	0.000E+00
STORY3	9-6	6.497E-01	6.497E-01	6.497E-01	0.000E+00	0.000E+00	0.000E+00
STORY3	10-6	6.470E-01	6.470E-01	6.470E-01	0.000E+00	0.000E+00	0.000E+00
STORY3	11-6	1.581E+00	1.581E+00	1.581E+00	0.000E+00	0.000E+00	0.000E+00
STORY3	12-6	6.524E-01	6.524E-01	6.524E-01	0.000E+00	0.000E+00	0.000E+00
STORY3	13-6	6.524E-01	6.524E-01	6.524E-01	0.000E+00	0.000E+00	0.000E+00
STORY3	14-6	6.524E-01	6.524E-01	6.524E-01	0.000E+00	0.000E+00	0.000E+00
STORY3	15-6	6.008E-01	6.008E-01	6.008E-01	0.000E+00	0.000E+00	0.000E+00
STORY3	16-6	6.741E+00	6.741E+00	6.741E+00	0.000E+00	0.000E+00	0.000E+00
STORY3	17-6	8.050E-01	8.050E-01	8.050E-01	0.000E+00	0.000E+00	0.000E+00
STORY3	18-6	8.930E-01	8.930E-01	8.930E-01	0.000E+00	0.000E+00	0.000E+00
STORY3	19-6	8.050E-01	8.050E-01	8.050E-01	0.000E+00	0.000E+00	0.000E+00
STORY3	20-6	1.786E+00	1.786E+00	1.786E+00	0.000E+00	0.000E+00	0.000E+00
STORY3	21-6	8.307E-01	8.307E-01	8.307E-01	0.000E+00	0.000E+00	0.000E+00
STORY3	22-6	8.346E-01	8.346E-01	8.346E-01	0.000E+00	0.000E+00	0.000E+00
STORY3	23-6	1.734E+00	1.734E+00	1.734E+00	0.000E+00	0.000E+00	0.000E+00
STORY3	24-6	8.520E-01	8.520E-01	8.520E-01	0.000E+00	0.000E+00	0.000E+00
STORY3	25-6	8.028E-01	8.028E-01	8.028E-01	0.000E+00	0.000E+00	0.000E+00
STORY3	26-6	8.505E-01	8.505E-01	8.505E-01	0.000E+00	0.000E+00	0.000E+00
STORY3	27-7	8.068E+00	8.068E+00	8.068E+00	0.000E+00	0.000E+00	0.000E+00
STORY3	28-6	8.184E-01	8.184E-01	8.184E-01	0.000E+00	0.000E+00	0.000E+00
STORY3	29-6	1.634E+01	1.634E+01	1.634E+01	0.000E+00	0.000E+00	0.000E+00
STORY3	30-6	8.303E-01	8.303E-01	8.303E-01	0.000E+00	0.000E+00	0.000E+00
STORY3	31-6	9.489E-01	9.489E-01	9.489E-01	0.000E+00	0.000E+00	0.000E+00
STORY3	32-6	9.489E-01	9.489E-01	9.489E-01	0.000E+00	0.000E+00	0.000E+00
STORY3	33-6	9.489E-01	9.489E-01	9.489E-01	0.000E+00	0.000E+00	0.000E+00
STORY3	34-6	9.489E-01	9.489E-01	9.489E-01	0.000E+00	0.000E+00	0.000E+00
STORY3	35-6	9.489E-01	9.489E-01	9.489E-01	0.000E+00	0.000E+00	0.000E+00
STORY3	36-6	9.489E-01	9.489E-01	9.489E-01	0.000E+00	0.000E+00	0.000E+00
STORY3	37-6	9.489E-01	9.489E-01	9.489E-01	0.000E+00	0.000E+00	0.000E+00
STORY3	38-6	9.489E-01	9.489E-01	9.489E-01	0.000E+00	0.000E+00	0.000E+00
STORY3	39-6	9.489E-01	9.489E-01	9.489E-01	0.000E+00	0.000E+00	0.000E+00
STORY3	40-6	9.489E-01	9.489E-01	9.489E-01	0.000E+00	0.000E+00	0.000E+00
STORY3	41-6	7.860E-01	7.860E-01	7.860E-01	0.000E+00	0.000E+00	0.000E+00
STORY3	42-6	1.556E+01	1.556E+01	1.556E+01	0.000E+00	0.000E+00	0.000E+00
STORY3	46-1	7.784E-01	7.784E-01	7.784E-01	0.000E+00	0.000E+00	0.000E+00
STORY3	47-1	7.784E-01	7.784E-01	7.784E-01	0.000E+00	0.000E+00	0.000E+00
STORY3	43-2	1.001E+00	1.001E+00	1.001E+00	0.000E+00	0.000E+00	0.000E+00
STORY3	44-2	9.761E-01	9.761E-01	9.761E-01	0.000E+00	0.000E+00	0.000E+00
STORY3	48-1	7.290E-01	7.290E-01	7.290E-01	0.000E+00	0.000E+00	0.000E+00
STORY3	49-1	7.290E-01	7.290E-01	7.290E-01	0.000E+00	0.000E+00	0.000E+00
STORY3	50-1	1.283E+00	1.283E+00	1.283E+00	0.000E+00	0.000E+00	0.000E+00
STORY3	51-1	1.283E+00	1.283E+00	1.283E+00	0.000E+00	0.000E+00	0.000E+00
STORY3	52-1	1.467E+00	1.467E+00	1.467E+00	0.000E+00	0.000E+00	0.000E+00
STORY3	53-1	1.609E+00	1.609E+00	1.609E+00	0.000E+00	0.000E+00	0.000E+00
STORY3	54-1	1.385E+00	1.385E+00	1.385E+00	0.000E+00	0.000E+00	0.000E+00
STORY3	55-1	1.202E+00	1.202E+00	1.202E+00	0.000E+00	0.000E+00	0.000E+00
STORY3	27-8	1.420E+00	1.420E+00	1.420E+00	0.000E+00	0.000E+00	0.000E+00
STORY3	50-8	1.308E+00	1.308E+00	1.308E+00	0.000E+00	0.000E+00	0.000E+00
STORY3	51-8	1.308E+00	1.308E+00	1.308E+00	0.000E+00	0.000E+00	0.000E+00
STORY3	52-8	1.495E+00	1.495E+00	1.495E+00	0.000E+00	0.000E+00	0.000E+00
STORY3	53-8	1.641E+00	1.641E+00	1.641E+00	0.000E+00	0.000E+00	0.000E+00
STORY3	54-8	1.412E+00	1.412E+00	1.412E+00	0.000E+00	0.000E+00	0.000E+00
STORY3	55-8	1.225E+00	1.225E+00	1.225E+00	0.000E+00	0.000E+00	0.000E+00
STORY3	42-8	1.233E+00	1.233E+00	1.233E+00	0.000E+00	0.000E+00	0.000E+00
STORY3	27-9	8.614E+00	8.614E+00	8.614E+00	0.000E+00	0.000E+00	0.000E+00
STORY3	50-9	8.555E-01	8.555E-01	8.555E-01	0.000E+00	0.000E+00	0.000E+00
STORY3	51-9	8.555E-01	8.555E-01	8.555E-01	0.000E+00	0.000E+00	0.000E+00
STORY3	52-9	9.777E-01	9.777E-01	9.777E-01	0.000E+00	0.000E+00	0.000E+00
STORY3	53-9	1.073E+00	1.073E+00	1.073E+00	0.000E+00	0.000E+00	0.000E+00
STORY3	54-9	9.234E-01	9.234E-01	9.234E-01	0.000E+00	0.000E+00	0.000E+00
STORY3	55-9	8.012E-01	8.012E-01	8.012E-01	0.000E+00	0.000E+00	0.000E+00
STORY3	42-9	2.642E+01	2.642E+01	2.642E+01	0.000E+00	0.000E+00	0.000E+00
STORY3	87-1	7.213E-01	7.213E-01	7.213E-01	0.000E+00	0.000E+00	0.000E+00
STORY3	88-1	9.930E-01	9.930E-01	9.930E-01	0.000E+00	0.000E+00	0.000E+00
STORY3	88-2	1.069E+00	1.069E+00	1.069E+00	0.000E+00	0.000E+00	0.000E+00
STORY3	87-2	2.041E+00	2.041E+00	2.041E+00	0.000E+00	0.000E+00	0.000E+00
STORY3	89-1	9.871E-01	9.871E-01	9.871E-01	0.000E+00	0.000E+00	0.000E+00
STORY3	89-2	1.063E+00	1.063E+00	1.063E+00	0.000E+00	0.000E+00	0.000E+00
STORY3	66-6	1.589E+00	1.589E+00	1.589E+00	0.000E+00	0.000E+00	0.000E+00
STORY3	67-6	1.033E+00	1.033E+00	1.033E+00	0.000E+00	0.000E+00	0.000E+00
STORY3	67-7	8.853E-01	8.853E-01	8.853E-01	0.000E+00	0.000E+00	0.000E+00
STORY3	66-7	1.661E+00	1.661E+00	1.661E+00	0.000E+00	0.000E+00	0.000E+00
STORY3	68-6	1.311E+00	1.311E+00	1.311E+00	0.000E+00	0.000E+00	0.000E+00
STORY3	68-7	9.578E-01	9.578E-01	9.578E-01	0.000E+00	0.000E+00	0.000E+00
STORY3	69-6	9.864E-01	9.864E-01	9.864E-01	0.000E+00	0.000E+00	0.000E+00
STORY3	70-6	9.599E-01	9.599E-01	9.599E-01	0.000E+00	0.000E+00	0.000E+00
STORY3	70-7	8.160E-01	8.160E-01	8.160E-01	0.000E+00	0.000E+00	0.000E+00
STORY3	69-7	8.354E-01	8.354E-01	8.354E-01	0.000E+00	0.000E+00	0.000E+00
STORY3	71-6	9.494E-01	9.494E-01	9.494E-01	0.000E+00	0.000E+00	0.000E+00
STORY3	71-7	6.938E-01	6.938E-01	6.938E-01	0.000E+00	0.000E+00	0.000E+00
STORY3	72-6	9.932E-01	9.932E-01	9.932E-01	0.000E+00	0.000E+00	0.000E+00
STORY3	73-6	1.327E+00	1.327E+00	1.327E+00	0.000E+00	0.000E+00	0.000E+00
STORY3	73-7	3.218E+00	3.218E+00	3.218E+00	0.000E+00	0.000E+00	0.000E+00
STORY3	72-7	9.628E-01	9.628E-01	9.628E-01	0.000E+00	0.000E+00	0.000E+00

ASSEMBLED POINT MASSES

STORY	POINT	UX	UY	UZ	RX	RY	RZ
STORY3	75-2	1.235E+00	1.235E+00	1.235E+00	0.000E+00	0.000E+00	0.000E+00
STORY3	75-3	1.330E+00	1.330E+00	1.330E+00	0.000E+00	0.000E+00	0.000E+00
STORY3	76-6	1.255E+00	1.255E+00	1.255E+00	0.000E+00	0.000E+00	0.000E+00
STORY3	76-7	1.122E+00	1.122E+00	1.122E+00	0.000E+00	0.000E+00	0.000E+00
STORY3	77-6	1.225E+00	1.225E+00	1.225E+00	0.000E+00	0.000E+00	0.000E+00
STORY3	78-6	1.309E+00	1.309E+00	1.309E+00	0.000E+00	0.000E+00	0.000E+00
STORY3	78-7	3.106E+01	3.106E+01	3.106E+01	0.000E+00	0.000E+00	0.000E+00
STORY3	77-7	1.267E+00	1.267E+00	1.267E+00	0.000E+00	0.000E+00	0.000E+00
STORY3	79-6	1.324E+00	1.324E+00	1.324E+00	0.000E+00	0.000E+00	0.000E+00
STORY3	79-7	9.675E-01	9.675E-01	9.675E-01	0.000E+00	0.000E+00	0.000E+00
STORY3	81-5	1.170E+00	1.170E+00	1.170E+00	0.000E+00	0.000E+00	0.000E+00
STORY3	81-6	9.916E-01	9.916E-01	9.916E-01	0.000E+00	0.000E+00	0.000E+00
STORY3	82-6	6.289E-01	6.289E-01	6.289E-01	0.000E+00	0.000E+00	0.000E+00
STORY3	82-7	4.596E-01	4.596E-01	4.596E-01	0.000E+00	0.000E+00	0.000E+00
STORY3	83-6	1.004E+00	1.004E+00	1.004E+00	0.000E+00	0.000E+00	0.000E+00
STORY3	84-6	9.930E-01	9.930E-01	9.930E-01	0.000E+00	0.000E+00	0.000E+00
STORY3	84-7	4.965E-01	4.965E-01	4.965E-01	0.000E+00	0.000E+00	0.000E+00
STORY3	83-7	1.040E+00	1.040E+00	1.040E+00	0.000E+00	0.000E+00	0.000E+00
STORY3	85-6	9.930E-01	9.930E-01	9.930E-01	0.000E+00	0.000E+00	0.000E+00
STORY3	85-7	4.965E-01	4.965E-01	4.965E-01	0.000E+00	0.000E+00	0.000E+00
STORY3	86-6	7.613E-01	7.613E-01	7.613E-01	0.000E+00	0.000E+00	0.000E+00
STORY3	86-7	3.806E-01	3.806E-01	3.806E-01	0.000E+00	0.000E+00	0.000E+00
STORY3	68-9	6.465E-01	6.465E-01	6.465E-01	0.000E+00	0.000E+00	0.000E+00
STORY3	67-9	7.885E-01	7.885E-01	7.885E-01	0.000E+00	0.000E+00	0.000E+00
STORY3	71-9	4.683E-01	4.683E-01	4.683E-01	0.000E+00	0.000E+00	0.000E+00
STORY3	70-9	7.183E-01	7.183E-01	7.183E-01	0.000E+00	0.000E+00	0.000E+00
STORY3	79-9	6.530E-01	6.530E-01	6.530E-01	0.000E+00	0.000E+00	0.000E+00
STORY3	76-9	1.057E+00	1.057E+00	1.057E+00	0.000E+00	0.000E+00	0.000E+00
STORY3	81-8	8.586E-01	8.586E-01	8.586E-01	0.000E+00	0.000E+00	0.000E+00
STORY3	82-9	3.102E-01	3.102E-01	3.102E-01	0.000E+00	0.000E+00	0.000E+00
STORY3	69-9	7.314E-01	7.314E-01	7.314E-01	0.000E+00	0.000E+00	0.000E+00
STORY3	72-9	9.965E-01	9.965E-01	9.965E-01	0.000E+00	0.000E+00	0.000E+00
STORY3	78-10	1.984E+00	1.984E+00	1.984E+00	0.000E+00	0.000E+00	0.000E+00
STORY3	93-1	1.322E+00	1.322E+00	1.322E+00	0.000E+00	0.000E+00	0.000E+00
STORY3	93-2	8.211E-01	8.211E-01	8.211E-01	0.000E+00	0.000E+00	0.000E+00
STORY3	94-1	7.256E-01	7.256E-01	7.256E-01	0.000E+00	0.000E+00	0.000E+00
STORY3	94-2	7.256E-01	7.256E-01	7.256E-01	0.000E+00	0.000E+00	0.000E+00
STORY3	3-7	2.820E+01	2.820E+01	2.820E+01	0.000E+00	0.000E+00	0.000E+00
STORY3	3-8	7.938E-01	7.938E-01	7.938E-01	0.000E+00	0.000E+00	0.000E+00
STORY3	95-1	5.729E-01	5.729E-01	5.729E-01	0.000E+00	0.000E+00	0.000E+00
STORY3	96-1	5.538E-01	5.538E-01	5.538E-01	0.000E+00	0.000E+00	0.000E+00
STORY3	96-2	8.615E-01	8.615E-01	8.615E-01	0.000E+00	0.000E+00	0.000E+00
STORY3	95-2	8.844E-01	8.844E-01	8.844E-01	0.000E+00	0.000E+00	0.000E+00
STORY3	97-1	6.874E-01	6.874E-01	6.874E-01	0.000E+00	0.000E+00	0.000E+00
STORY3	87-5	1.277E+00	1.277E+00	1.277E+00	0.000E+00	0.000E+00	0.000E+00
STORY3	97-2	6.874E-01	6.874E-01	6.874E-01	0.000E+00	0.000E+00	0.000E+00
STORY3	88-5	1.224E+00	1.224E+00	1.224E+00	0.000E+00	0.000E+00	0.000E+00
STORY3	89-5	1.217E+00	1.217E+00	1.217E+00	0.000E+00	0.000E+00	0.000E+00
STORY3	66-9	1.852E+00	1.852E+00	1.852E+00	0.000E+00	0.000E+00	0.000E+00
STORY3	73-9	3.476E+00	3.476E+00	3.476E+00	0.000E+00	0.000E+00	0.000E+00
STORY3	75-5	1.523E+00	1.523E+00	1.523E+00	0.000E+00	0.000E+00	0.000E+00
STORY3	77-9	1.010E+00	1.010E+00	1.010E+00	0.000E+00	0.000E+00	0.000E+00
STORY3	99-3	1.226E+00	1.226E+00	1.226E+00	0.000E+00	0.000E+00	0.000E+00
STORY3	99-4	9.133E-01	9.133E-01	9.133E-01	0.000E+00	0.000E+00	0.000E+00
STORY3	100-3	5.585E-01	5.585E-01	5.585E-01	0.000E+00	0.000E+00	0.000E+00
STORY3	100-4	7.721E-01	7.721E-01	7.721E-01	0.000E+00	0.000E+00	0.000E+00
STORY3	101-1	3.858E-01	3.858E-01	3.858E-01	0.000E+00	0.000E+00	0.000E+00
STORY3	101-2	8.244E-01	8.244E-01	8.244E-01	0.000E+00	0.000E+00	0.000E+00
STORY3	102-1	6.610E-01	6.610E-01	6.610E-01	0.000E+00	0.000E+00	0.000E+00
STORY3	103-1	1.721E+00	1.721E+00	1.721E+00	0.000E+00	0.000E+00	0.000E+00
STORY3	103-2	1.256E+00	1.256E+00	1.256E+00	0.000E+00	0.000E+00	0.000E+00
STORY3	102-2	9.824E-01	9.824E-01	9.824E-01	0.000E+00	0.000E+00	0.000E+00
STORY3	104-1	7.856E-01	7.856E-01	7.856E-01	0.000E+00	0.000E+00	0.000E+00
STORY3	104-2	1.252E+00	1.252E+00	1.252E+00	0.000E+00	0.000E+00	0.000E+00
STORY3	105-1	7.977E-01	7.977E-01	7.977E-01	0.000E+00	0.000E+00	0.000E+00
STORY3	105-2	1.278E+00	1.278E+00	1.278E+00	0.000E+00	0.000E+00	0.000E+00
STORY3	106-1	7.930E-01	7.930E-01	7.930E-01	0.000E+00	0.000E+00	0.000E+00
STORY3	106-2	1.273E+00	1.273E+00	1.273E+00	0.000E+00	0.000E+00	0.000E+00
STORY3	107-1	7.915E-01	7.915E-01	7.915E-01	0.000E+00	0.000E+00	0.000E+00
STORY3	107-2	1.270E+00	1.270E+00	1.270E+00	0.000E+00	0.000E+00	0.000E+00
STORY3	108-1	7.961E-01	7.961E-01	7.961E-01	0.000E+00	0.000E+00	0.000E+00
STORY3	108-2	1.275E+00	1.275E+00	1.275E+00	0.000E+00	0.000E+00	0.000E+00
STORY3	109-1	8.851E-01	8.851E-01	8.851E-01	0.000E+00	0.000E+00	0.000E+00
STORY3	109-2	1.465E+00	1.465E+00	1.465E+00	0.000E+00	0.000E+00	0.000E+00
STORY3	110-1	1.012E+01	1.012E+01	1.012E+01	0.000E+00	0.000E+00	0.000E+00
STORY3	110-2	3.228E+00	3.228E+00	3.228E+00	0.000E+00	0.000E+00	0.000E+00
STORY3	99-5	7.510E-01	7.510E-01	7.510E-01	0.000E+00	0.000E+00	0.000E+00
STORY3	112-2	1.158E+00	1.158E+00	1.158E+00	0.000E+00	0.000E+00	0.000E+00
STORY3	115-3	1.002E+00	1.002E+00	1.002E+00	0.000E+00	0.000E+00	0.000E+00
STORY3	115-4	7.399E-01	7.399E-01	7.399E-01	0.000E+00	0.000E+00	0.000E+00
STORY3	116-1	4.525E-01	4.525E-01	4.525E-01	0.000E+00	0.000E+00	0.000E+00
STORY3	116-2	6.346E-01	6.346E-01	6.346E-01	0.000E+00	0.000E+00	0.000E+00
STORY3	117-1	5.355E-01	5.355E-01	5.355E-01	0.000E+00	0.000E+00	0.000E+00
STORY3	118-1	6.393E-01	6.393E-01	6.393E-01	0.000E+00	0.000E+00	0.000E+00
STORY3	118-2	1.027E+00	1.027E+00	1.027E+00	0.000E+00	0.000E+00	0.000E+00
STORY3	117-2	8.051E-01	8.051E-01	8.051E-01	0.000E+00	0.000E+00	0.000E+00
STORY3	119-1	6.364E-01	6.364E-01	6.364E-01	0.000E+00	0.000E+00	0.000E+00





0003543A7F908851CD669C51C48E7881

Ημ/νία έκδοσης πρόχεις: 07/06/2022

ΕΛΕΓΧΟΣ ΕΓΚΥΡΟΤΗΤΑΣ

<https://apps.tee.gr/adeiapublic/faces/searchDocFile>

ETABS v9.7.0 File:ANATOLIKH_PTERYGA_3000_ENISXISI Units:KN-m ΟαδδΥιανέιθ 23, 2010 9:52 PAGE 10

A S S E M B L E D P O I N T M A S S E S

STORY	POINT	UX	UY	UZ	RX	RY	RZ
STORY3	119-2	1.024E+00	1.024E+00	1.024E+00	0.000E+00	0.000E+00	0.000E+00
STORY3	120-1	6.463E-01	6.463E-01	6.463E-01	0.000E+00	0.000E+00	0.000E+00
STORY3	120-2	1.045E+00	1.045E+00	1.045E+00	0.000E+00	0.000E+00	0.000E+00
STORY3	121-1	6.425E-01	6.425E-01	6.425E-01	0.000E+00	0.000E+00	0.000E+00
STORY3	121-2	1.040E+00	1.040E+00	1.040E+00	0.000E+00	0.000E+00	0.000E+00
STORY3	122-1	6.412E-01	6.412E-01	6.412E-01	0.000E+00	0.000E+00	0.000E+00
STORY3	122-2	1.038E+00	1.038E+00	1.038E+00	0.000E+00	0.000E+00	0.000E+00
STORY3	123-1	6.449E-01	6.449E-01	6.449E-01	0.000E+00	0.000E+00	0.000E+00
STORY3	123-2	1.042E+00	1.042E+00	1.042E+00	0.000E+00	0.000E+00	0.000E+00
STORY3	124-1	7.171E-01	7.171E-01	7.171E-01	0.000E+00	0.000E+00	0.000E+00
STORY3	124-2	1.196E+00	1.196E+00	1.196E+00	0.000E+00	0.000E+00	0.000E+00
STORY3	125-1	3.730E+00	3.730E+00	3.730E+00	0.000E+00	0.000E+00	0.000E+00
STORY3	125-2	2.059E+00	2.059E+00	2.059E+00	0.000E+00	0.000E+00	0.000E+00
STORY3	126-1	5.959E-01	5.959E-01	5.959E-01	0.000E+00	0.000E+00	0.000E+00
STORY3	126-2	9.397E-01	9.397E-01	9.397E-01	0.000E+00	0.000E+00	0.000E+00
STORY3	113-2	6.165E-01	6.165E-01	6.165E-01	0.000E+00	0.000E+00	0.000E+00
STORY3	113-3	9.835E-01	9.835E-01	9.835E-01	0.000E+00	0.000E+00	0.000E+00
STORY3	114-2	5.859E-01	5.859E-01	5.859E-01	0.000E+00	0.000E+00	0.000E+00
STORY3	111-2	6.767E-01	6.767E-01	6.767E-01	0.000E+00	0.000E+00	0.000E+00
STORY3	111-3	1.007E+00	1.007E+00	1.007E+00	0.000E+00	0.000E+00	0.000E+00
STORY3	114-3	8.418E-01	8.418E-01	8.418E-01	0.000E+00	0.000E+00	0.000E+00
STORY3	127-1	6.878E-01	6.878E-01	6.878E-01	0.000E+00	0.000E+00	0.000E+00
STORY3	127-2	1.254E+00	1.254E+00	1.254E+00	0.000E+00	0.000E+00	0.000E+00
STORY3	112-4	2.507E+01	2.507E+01	2.507E+01	0.000E+00	0.000E+00	0.000E+00
STORY3	128-1	5.614E-01	5.614E-01	5.614E-01	0.000E+00	0.000E+00	0.000E+00
STORY3	128-2	1.200E+00	1.200E+00	1.200E+00	0.000E+00	0.000E+00	0.000E+00
STORY3	129-1	5.890E-01	5.890E-01	5.890E-01	0.000E+00	0.000E+00	0.000E+00
STORY3	129-2	1.227E+00	1.227E+00	1.227E+00	0.000E+00	0.000E+00	0.000E+00
STORY3	130-1	5.614E-01	5.614E-01	5.614E-01	0.000E+00	0.000E+00	0.000E+00
STORY3	130-2	1.056E+00	1.056E+00	1.056E+00	0.000E+00	0.000E+00	0.000E+00
STORY3	115-5	6.084E-01	6.084E-01	6.084E-01	0.000E+00	0.000E+00	0.000E+00
STORY3	131-1	3.125E-01	3.125E-01	3.125E-01	0.000E+00	0.000E+00	0.000E+00
STORY3	131-2	6.679E-01	6.679E-01	6.679E-01	0.000E+00	0.000E+00	0.000E+00
STORY3	132-6	1.274E+00	1.274E+00	1.274E+00	0.000E+00	0.000E+00	0.000E+00
STORY3	132-7	6.987E-01	6.987E-01	6.987E-01	0.000E+00	0.000E+00	0.000E+00
STORY3	133-6	1.053E+00	1.053E+00	1.053E+00	0.000E+00	0.000E+00	0.000E+00
STORY3	133-7	5.775E-01	5.775E-01	5.775E-01	0.000E+00	0.000E+00	0.000E+00
STORY3	134-6	7.085E-01	7.085E-01	7.085E-01	0.000E+00	0.000E+00	0.000E+00
STORY3	134-7	3.885E-01	3.885E-01	3.885E-01	0.000E+00	0.000E+00	0.000E+00
STORY3	135-6	5.822E-01	5.822E-01	5.822E-01	0.000E+00	0.000E+00	0.000E+00
STORY3	135-7	1.062E+00	1.062E+00	1.062E+00	0.000E+00	0.000E+00	0.000E+00
STORY3	136-6	5.822E-01	5.822E-01	5.822E-01	0.000E+00	0.000E+00	0.000E+00
STORY3	136-7	1.062E+00	1.062E+00	1.062E+00	0.000E+00	0.000E+00	0.000E+00
STORY3	137-6	8.151E-01	8.151E-01	8.151E-01	0.000E+00	0.000E+00	0.000E+00
STORY3	137-7	1.111E+00	1.111E+00	1.111E+00	0.000E+00	0.000E+00	0.000E+00
STORY3	138-3	8.733E-01	8.733E-01	8.733E-01	0.000E+00	0.000E+00	0.000E+00
STORY3	138-4	1.217E+00	1.217E+00	1.217E+00	0.000E+00	0.000E+00	0.000E+00
STORY3	139-6	6.880E-01	6.880E-01	6.880E-01	0.000E+00	0.000E+00	0.000E+00
STORY3	139-7	1.255E+00	1.255E+00	1.255E+00	0.000E+00	0.000E+00	0.000E+00
STORY3	140-6	8.555E-01	8.555E-01	8.555E-01	0.000E+00	0.000E+00	0.000E+00
STORY3	140-7	1.560E+00	1.560E+00	1.560E+00	0.000E+00	0.000E+00	0.000E+00
STORY3	141-4	6.773E-01	6.773E-01	6.773E-01	0.000E+00	0.000E+00	0.000E+00
STORY3	141-5	1.235E+00	1.235E+00	1.235E+00	0.000E+00	0.000E+00	0.000E+00
STORY3	156-5	1.387E+00	1.387E+00	1.387E+00	0.000E+00	0.000E+00	0.000E+00
STORY3	156-6	6.487E-01	6.487E-01	6.487E-01	0.000E+00	0.000E+00	0.000E+00
STORY3	157-5	1.387E+00	1.387E+00	1.387E+00	0.000E+00	0.000E+00	0.000E+00
STORY3	157-6	6.487E-01	6.487E-01	6.487E-01	0.000E+00	0.000E+00	0.000E+00
STORY3	158-5	1.387E+00	1.387E+00	1.387E+00	0.000E+00	0.000E+00	0.000E+00
STORY3	158-6	6.487E-01	6.487E-01	6.487E-01	0.000E+00	0.000E+00	0.000E+00
STORY3	159-5	1.387E+00	1.387E+00	1.387E+00	0.000E+00	0.000E+00	0.000E+00
STORY3	159-6	6.487E-01	6.487E-01	6.487E-01	0.000E+00	0.000E+00	0.000E+00
STORY3	160-5	1.387E+00	1.387E+00	1.387E+00	0.000E+00	0.000E+00	0.000E+00
STORY3	160-6	6.487E-01	6.487E-01	6.487E-01	0.000E+00	0.000E+00	0.000E+00
STORY3	161-5	1.627E+00	1.627E+00	1.627E+00	0.000E+00	0.000E+00	0.000E+00
STORY3	161-6	7.613E-01	7.613E-01	7.613E-01	0.000E+00	0.000E+00	0.000E+00
STORY3	162-3	1.323E+00	1.323E+00	1.323E+00	0.000E+00	0.000E+00	0.000E+00
STORY3	162-4	6.190E-01	6.190E-01	6.190E-01	0.000E+00	0.000E+00	0.000E+00
STORY3	163-6	8.930E-01	8.930E-01	8.930E-01	0.000E+00	0.000E+00	0.000E+00
STORY3	163-7	8.275E-01	8.275E-01	8.275E-01	0.000E+00	0.000E+00	0.000E+00
STORY3	165-3	2.085E-01	2.085E-01	2.085E-01	0.000E+00	0.000E+00	0.000E+00
STORY3	165-4	5.050E-01	5.050E-01	5.050E-01	0.000E+00	0.000E+00	0.000E+00
STORY3	166-6	1.056E+00	1.056E+00	1.056E+00	0.000E+00	0.000E+00	0.000E+00
STORY3	167-3	3.784E-01	3.784E-01	3.784E-01	0.000E+00	0.000E+00	0.000E+00
STORY3	166-7	9.731E-01	9.731E-01	9.731E-01	0.000E+00	0.000E+00	0.000E+00
STORY3	167-4	6.506E-01	6.506E-01	6.506E-01	0.000E+00	0.000E+00	0.000E+00
STORY3	168-6	1.387E+00	1.387E+00	1.387E+00	0.000E+00	0.000E+00	0.000E+00
STORY3	168-7	1.297E+00	1.297E+00	1.297E+00	0.000E+00	0.000E+00	0.000E+00
STORY3	153-7	1.296E+00	1.296E+00	1.296E+00	0.000E+00	0.000E+00	0.000E+00
STORY3	153-8	1.213E+00	1.213E+00	1.213E+00	0.000E+00	0.000E+00	0.000E+00
STORY3	163-8	8.187E-01	8.187E-01	8.187E-01	0.000E+00	0.000E+00	0.000E+00
STORY3	165-5	8.388E-01	8.388E-01	8.388E-01	0.000E+00	0.000E+00	0.000E+00
STORY3	166-8	9.572E-01	9.572E-01	9.572E-01	0.000E+00	0.000E+00	0.000E+00
STORY3	167-5	9.701E-01	9.701E-01	9.701E-01	0.000E+00	0.000E+00	0.000E+00
STORY3	168-8	1.297E+00	1.297E+00	1.297E+00	0.000E+00	0.000E+00	0.000E+00
STORY3	153-9	1.213E+00	1.213E+00	1.213E+00	0.000E+00	0.000E+00	0.000E+00
STORY3	169-1	4.387E-01	4.387E-01	4.387E-01	0.000E+00	0.000E+00	0.000E+00
STORY3	169-2	3.975E-01	3.975E-01	3.975E-01	0.000E+00	0.000E+00	0.000E+00

ASSEMBLED POINT MASSES

STORY	POINT	UX	UY	UZ	RX	RY	RZ
STORY3	169-7	4.063E-01	4.063E-01	4.063E-01	0.000E+00	0.000E+00	0.000E+00
STORY3	170-1	4.063E-01	4.063E-01	4.063E-01	0.000E+00	0.000E+00	0.000E+00
STORY3	170-2	5.420E-01	5.420E-01	5.420E-01	0.000E+00	0.000E+00	0.000E+00
STORY3	171-2	8.066E-01	8.066E-01	8.066E-01	0.000E+00	0.000E+00	0.000E+00
STORY3	172-2	4.033E-01	4.033E-01	4.033E-01	0.000E+00	0.000E+00	0.000E+00
STORY3	171-4	7.708E-01	7.708E-01	7.708E-01	0.000E+00	0.000E+00	0.000E+00
STORY3	172-4	3.764E-01	3.764E-01	3.764E-01	0.000E+00	0.000E+00	0.000E+00
STORY3	171-5	6.094E-01	6.094E-01	6.094E-01	0.000E+00	0.000E+00	0.000E+00
STORY3	172-5	3.047E-01	3.047E-01	3.047E-01	0.000E+00	0.000E+00	0.000E+00
STORY3	173-5	6.513E-01	6.513E-01	6.513E-01	0.000E+00	0.000E+00	0.000E+00
STORY3	174-5	3.256E-01	3.256E-01	3.256E-01	0.000E+00	0.000E+00	0.000E+00
STORY3	173-6	6.094E-01	6.094E-01	6.094E-01	0.000E+00	0.000E+00	0.000E+00
STORY3	174-6	3.047E-01	3.047E-01	3.047E-01	0.000E+00	0.000E+00	0.000E+00
STORY3	173-7	6.094E-01	6.094E-01	6.094E-01	0.000E+00	0.000E+00	0.000E+00
STORY3	174-7	3.047E-01	3.047E-01	3.047E-01	0.000E+00	0.000E+00	0.000E+00
STORY3	142-6	9.930E-01	9.930E-01	9.930E-01	0.000E+00	0.000E+00	0.000E+00
STORY3	143-6	1.126E+00	1.126E+00	1.126E+00	0.000E+00	0.000E+00	0.000E+00
STORY3	143-7	1.203E+00	1.203E+00	1.203E+00	0.000E+00	0.000E+00	0.000E+00
STORY3	142-7	1.061E+00	1.061E+00	1.061E+00	0.000E+00	0.000E+00	0.000E+00
STORY3	144-2	4.302E-01	4.302E-01	4.302E-01	0.000E+00	0.000E+00	0.000E+00
STORY3	144-3	4.597E-01	4.597E-01	4.597E-01	0.000E+00	0.000E+00	0.000E+00
STORY3	146-6	8.905E-01	8.905E-01	8.905E-01	0.000E+00	0.000E+00	0.000E+00
STORY3	155-2	3.437E-01	3.437E-01	3.437E-01	0.000E+00	0.000E+00	0.000E+00
STORY3	155-3	3.673E-01	3.673E-01	3.673E-01	0.000E+00	0.000E+00	0.000E+00
STORY3	146-7	9.516E-01	9.516E-01	9.516E-01	0.000E+00	0.000E+00	0.000E+00
STORY3	147-6	1.292E+00	1.292E+00	1.292E+00	0.000E+00	0.000E+00	0.000E+00
STORY3	147-7	1.381E+00	1.381E+00	1.381E+00	0.000E+00	0.000E+00	0.000E+00
STORY3	148-6	7.457E-01	7.457E-01	7.457E-01	0.000E+00	0.000E+00	0.000E+00
STORY3	148-7	7.969E-01	7.969E-01	7.969E-01	0.000E+00	0.000E+00	0.000E+00
STORY3	150-6	1.359E+00	1.359E+00	1.359E+00	0.000E+00	0.000E+00	0.000E+00
STORY3	154-2	6.131E-01	6.131E-01	6.131E-01	0.000E+00	0.000E+00	0.000E+00
STORY3	154-3	6.551E-01	6.551E-01	6.551E-01	0.000E+00	0.000E+00	0.000E+00
STORY3	150-7	1.452E+00	1.452E+00	1.452E+00	0.000E+00	0.000E+00	0.000E+00
STORY3	152-6	1.188E+00	1.188E+00	1.188E+00	0.000E+00	0.000E+00	0.000E+00
STORY3	152-7	1.269E+00	1.269E+00	1.269E+00	0.000E+00	0.000E+00	0.000E+00
STORY3	142-9	9.930E-01	9.930E-01	9.930E-01	0.000E+00	0.000E+00	0.000E+00
STORY3	143-9	1.126E+00	1.126E+00	1.126E+00	0.000E+00	0.000E+00	0.000E+00
STORY3	144-5	9.343E-01	9.343E-01	9.343E-01	0.000E+00	0.000E+00	0.000E+00
STORY3	146-9	8.905E-01	8.905E-01	8.905E-01	0.000E+00	0.000E+00	0.000E+00
STORY3	155-4	8.479E-01	8.479E-01	8.479E-01	0.000E+00	0.000E+00	0.000E+00
STORY3	147-9	1.292E+00	1.292E+00	1.292E+00	0.000E+00	0.000E+00	0.000E+00
STORY3	148-9	8.882E-01	8.882E-01	8.882E-01	0.000E+00	0.000E+00	0.000E+00
STORY3	150-9	1.359E+00	1.359E+00	1.359E+00	0.000E+00	0.000E+00	0.000E+00
STORY3	154-5	9.978E-01	9.978E-01	9.978E-01	0.000E+00	0.000E+00	0.000E+00
STORY3	152-9	1.188E+00	1.188E+00	1.188E+00	0.000E+00	0.000E+00	0.000E+00
STORY3	149-8	4.392E-01	4.392E-01	4.392E-01	0.000E+00	0.000E+00	0.000E+00
STORY3	176-6	1.690E+00	1.690E+00	1.690E+00	0.000E+00	0.000E+00	0.000E+00
STORY3	177-6	1.194E+00	1.194E+00	1.194E+00	0.000E+00	0.000E+00	0.000E+00
STORY3	177-7	1.276E+00	1.276E+00	1.276E+00	0.000E+00	0.000E+00	0.000E+00
STORY3	176-7	1.806E+00	1.806E+00	1.806E+00	0.000E+00	0.000E+00	0.000E+00
STORY3	178-6	1.690E+00	1.690E+00	1.690E+00	0.000E+00	0.000E+00	0.000E+00
STORY3	178-7	1.806E+00	1.806E+00	1.806E+00	0.000E+00	0.000E+00	0.000E+00
STORY3	179-6	1.513E+00	1.513E+00	1.513E+00	0.000E+00	0.000E+00	0.000E+00
STORY3	179-7	1.616E+00	1.616E+00	1.616E+00	0.000E+00	0.000E+00	0.000E+00
STORY3	180-6	6.675E-01	6.675E-01	6.675E-01	0.000E+00	0.000E+00	0.000E+00
STORY3	180-7	7.133E-01	7.133E-01	7.133E-01	0.000E+00	0.000E+00	0.000E+00
STORY3	182-6	9.090E-01	9.090E-01	9.090E-01	0.000E+00	0.000E+00	0.000E+00
STORY3	181-6	6.561E-01	6.561E-01	6.561E-01	0.000E+00	0.000E+00	0.000E+00
STORY3	181-7	7.011E-01	7.011E-01	7.011E-01	0.000E+00	0.000E+00	0.000E+00
STORY3	182-7	9.713E-01	9.713E-01	9.713E-01	0.000E+00	0.000E+00	0.000E+00
STORY3	185-2	5.627E-01	5.627E-01	5.627E-01	0.000E+00	0.000E+00	0.000E+00
STORY3	185-3	6.013E-01	6.013E-01	6.013E-01	0.000E+00	0.000E+00	0.000E+00
STORY3	176-9	1.690E+00	1.690E+00	1.690E+00	0.000E+00	0.000E+00	0.000E+00
STORY3	177-9	1.194E+00	1.194E+00	1.194E+00	0.000E+00	0.000E+00	0.000E+00
STORY3	178-9	1.690E+00	1.690E+00	1.690E+00	0.000E+00	0.000E+00	0.000E+00
STORY3	179-9	1.513E+00	1.513E+00	1.513E+00	0.000E+00	0.000E+00	0.000E+00
STORY3	180-9	1.327E+00	1.327E+00	1.327E+00	0.000E+00	0.000E+00	0.000E+00
STORY3	182-9	9.679E-01	9.679E-01	9.679E-01	0.000E+00	0.000E+00	0.000E+00
STORY3	181-9	1.316E+00	1.316E+00	1.316E+00	0.000E+00	0.000E+00	0.000E+00
STORY3	185-5	1.163E+00	1.163E+00	1.163E+00	0.000E+00	0.000E+00	0.000E+00
STORY3	184-3	7.939E-01	7.939E-01	7.939E-01	0.000E+00	0.000E+00	0.000E+00
STORY3	184-5	2.529E-01	2.529E-01	2.529E-01	0.000E+00	0.000E+00	0.000E+00
STORY3	184-6	2.702E-01	2.702E-01	2.702E-01	0.000E+00	0.000E+00	0.000E+00
STORY3	188-1	1.222E-01	1.222E-01	1.222E-01	0.000E+00	0.000E+00	0.000E+00
STORY3	188-2	1.306E-01	1.306E-01	1.306E-01	0.000E+00	0.000E+00	0.000E+00
STORY3	187-6	2.648E-01	2.648E-01	2.648E-01	0.000E+00	0.000E+00	0.000E+00
STORY3	189-1	1.120E-01	1.120E-01	1.120E-01	0.000E+00	0.000E+00	0.000E+00
STORY3	189-2	1.197E-01	1.197E-01	1.197E-01	0.000E+00	0.000E+00	0.000E+00
STORY3	187-7	2.830E-01	2.830E-01	2.830E-01	0.000E+00	0.000E+00	0.000E+00
STORY3	188-4	2.903E-01	2.903E-01	2.903E-01	0.000E+00	0.000E+00	0.000E+00
STORY3	187-9	2.648E-01	2.648E-01	2.648E-01	0.000E+00	0.000E+00	0.000E+00
STORY3	189-4	2.801E-01	2.801E-01	2.801E-01	0.000E+00	0.000E+00	0.000E+00
STORY3	190-6	1.633E-01	1.633E-01	1.633E-01	0.000E+00	0.000E+00	0.000E+00
STORY3	190-8	1.528E-01	1.528E-01	1.528E-01	0.000E+00	0.000E+00	0.000E+00
STORY3	193-7	3.428E-01	3.428E-01	3.428E-01	0.000E+00	0.000E+00	0.000E+00
STORY3	193-8	3.208E-01	3.208E-01	3.208E-01	0.000E+00	0.000E+00	0.000E+00
STORY3	194-6	3.755E-01	3.755E-01	3.755E-01	0.000E+00	0.000E+00	0.000E+00



A S S E M B L E D P O I N T M A S S E S

STORY	POINT	UX	UY	UZ	RX	RY	RZ
STORY3	195-7	1.959E-01	1.959E-01	1.959E-01	0.000E+00	0.000E+00	0.000E+00
STORY3	194-8	3.514E-01	3.514E-01	3.514E-01	0.000E+00	0.000E+00	0.000E+00
STORY3	195-8	1.833E-01	1.833E-01	1.833E-01	0.000E+00	0.000E+00	0.000E+00
STORY3	196-3	1.796E-01	1.796E-01	1.796E-01	0.000E+00	0.000E+00	0.000E+00
STORY3	196-4	1.680E-01	1.680E-01	1.680E-01	0.000E+00	0.000E+00	0.000E+00
STORY3	197-3	1.680E-01	1.680E-01	1.680E-01	0.000E+00	0.000E+00	0.000E+00
STORY3	197-4	1.796E-01	1.796E-01	1.796E-01	0.000E+00	0.000E+00	0.000E+00
STORY3	190-9	3.056E-01	3.056E-01	3.056E-01	0.000E+00	0.000E+00	0.000E+00
STORY3	193-9	3.208E-01	3.208E-01	3.208E-01	0.000E+00	0.000E+00	0.000E+00
STORY3	194-9	3.514E-01	3.514E-01	3.514E-01	0.000E+00	0.000E+00	0.000E+00
STORY3	195-9	3.361E-01	3.361E-01	3.361E-01	0.000E+00	0.000E+00	0.000E+00
STORY3	196-5	4.355E-01	4.355E-01	4.355E-01	0.000E+00	0.000E+00	0.000E+00
STORY3	197-5	4.355E-01	4.355E-01	4.355E-01	0.000E+00	0.000E+00	0.000E+00
STORY3	198-6	7.055E-01	7.055E-01	7.055E-01	0.000E+00	0.000E+00	0.000E+00
STORY3	198-8	6.773E-01	6.773E-01	6.773E-01	0.000E+00	0.000E+00	0.000E+00
STORY3	199-6	6.643E-01	6.643E-01	6.643E-01	0.000E+00	0.000E+00	0.000E+00
STORY3	199-8	8.448E-01	8.448E-01	8.448E-01	0.000E+00	0.000E+00	0.000E+00
STORY3	200-6	7.200E-01	7.200E-01	7.200E-01	0.000E+00	0.000E+00	0.000E+00
STORY3	200-7	5.310E-01	5.310E-01	5.310E-01	0.000E+00	0.000E+00	0.000E+00
STORY3	201-6	5.904E-01	5.904E-01	5.904E-01	0.000E+00	0.000E+00	0.000E+00
STORY3	201-8	5.525E-01	5.525E-01	5.525E-01	0.000E+00	0.000E+00	0.000E+00
STORY3	198-9	6.773E-01	6.773E-01	6.773E-01	0.000E+00	0.000E+00	0.000E+00
STORY3	199-9	8.448E-01	8.448E-01	8.448E-01	0.000E+00	0.000E+00	0.000E+00
STORY3	200-9	7.200E-01	7.200E-01	7.200E-01	0.000E+00	0.000E+00	0.000E+00
STORY3	201-9	5.525E-01	5.525E-01	5.525E-01	0.000E+00	0.000E+00	0.000E+00
STORY2	1-4	1.113E+00	1.113E+00	1.113E+00	0.000E+00	0.000E+00	0.000E+00
STORY2	1-5	1.501E+00	1.501E+00	1.501E+00	0.000E+00	0.000E+00	0.000E+00
STORY2	2-4	2.674E+00	2.674E+00	2.674E+00	0.000E+00	0.000E+00	0.000E+00
STORY2	2-5	1.755E+00	1.755E+00	1.755E+00	0.000E+00	0.000E+00	0.000E+00
STORY2	3-4	3.839E+00	3.839E+00	3.839E+00	0.000E+00	0.000E+00	0.000E+00
STORY2	4-4	1.408E+00	1.408E+00	1.408E+00	0.000E+00	0.000E+00	0.000E+00
STORY2	4-5	1.722E+00	1.722E+00	1.722E+00	0.000E+00	0.000E+00	0.000E+00
STORY2	3-5	4.317E+00	4.317E+00	4.317E+00	0.000E+00	0.000E+00	0.000E+00
STORY2	5-3	1.303E+00	1.303E+00	1.303E+00	0.000E+00	0.000E+00	0.000E+00
STORY2	5-4	1.668E+00	1.668E+00	1.668E+00	0.000E+00	0.000E+00	0.000E+00
STORY2	6-3	1.298E+00	1.298E+00	1.298E+00	0.000E+00	0.000E+00	0.000E+00
STORY2	6-4	1.661E+00	1.661E+00	1.661E+00	0.000E+00	0.000E+00	0.000E+00
STORY2	7-3	1.306E+00	1.306E+00	1.306E+00	0.000E+00	0.000E+00	0.000E+00
STORY2	7-4	1.668E+00	1.668E+00	1.668E+00	0.000E+00	0.000E+00	0.000E+00
STORY2	8-3	1.302E+00	1.302E+00	1.302E+00	0.000E+00	0.000E+00	0.000E+00
STORY2	8-4	1.661E+00	1.661E+00	1.661E+00	0.000E+00	0.000E+00	0.000E+00
STORY2	9-3	1.293E+00	1.293E+00	1.293E+00	0.000E+00	0.000E+00	0.000E+00
STORY2	9-4	1.654E+00	1.654E+00	1.654E+00	0.000E+00	0.000E+00	0.000E+00
STORY2	10-3	1.289E+00	1.289E+00	1.289E+00	0.000E+00	0.000E+00	0.000E+00
STORY2	10-4	1.647E+00	1.647E+00	1.647E+00	0.000E+00	0.000E+00	0.000E+00
STORY2	11-3	1.306E+00	1.306E+00	1.306E+00	0.000E+00	0.000E+00	0.000E+00
STORY2	11-4	1.661E+00	1.661E+00	1.661E+00	0.000E+00	0.000E+00	0.000E+00
STORY2	12-3	1.306E+00	1.306E+00	1.306E+00	0.000E+00	0.000E+00	0.000E+00
STORY2	12-4	1.661E+00	1.661E+00	1.661E+00	0.000E+00	0.000E+00	0.000E+00
STORY2	13-3	1.306E+00	1.306E+00	1.306E+00	0.000E+00	0.000E+00	0.000E+00
STORY2	13-4	1.661E+00	1.661E+00	1.661E+00	0.000E+00	0.000E+00	0.000E+00
STORY2	14-3	1.306E+00	1.306E+00	1.306E+00	0.000E+00	0.000E+00	0.000E+00
STORY2	14-4	1.661E+00	1.661E+00	1.661E+00	0.000E+00	0.000E+00	0.000E+00
STORY2	15-4	1.150E+00	1.150E+00	1.150E+00	0.000E+00	0.000E+00	0.000E+00
STORY2	15-5	1.529E+00	1.529E+00	1.529E+00	0.000E+00	0.000E+00	0.000E+00
STORY2	16-4	3.725E+00	3.725E+00	3.725E+00	0.000E+00	0.000E+00	0.000E+00
STORY2	16-5	3.018E+00	3.018E+00	3.018E+00	0.000E+00	0.000E+00	0.000E+00
STORY2	17-4	2.464E+00	2.464E+00	2.464E+00	0.000E+00	0.000E+00	0.000E+00
STORY2	17-5	2.049E+00	2.049E+00	2.049E+00	0.000E+00	0.000E+00	0.000E+00
STORY2	18-4	2.273E+00	2.273E+00	2.273E+00	0.000E+00	0.000E+00	0.000E+00
STORY2	18-5	2.044E+00	2.044E+00	2.044E+00	0.000E+00	0.000E+00	0.000E+00
STORY2	19-4	2.464E+00	2.464E+00	2.464E+00	0.000E+00	0.000E+00	0.000E+00
STORY2	19-5	2.049E+00	2.049E+00	2.049E+00	0.000E+00	0.000E+00	0.000E+00
STORY2	20-4	1.984E+00	1.984E+00	1.984E+00	0.000E+00	0.000E+00	0.000E+00
STORY2	20-5	2.181E+00	2.181E+00	2.181E+00	0.000E+00	0.000E+00	0.000E+00
STORY2	21-4	1.910E+00	1.910E+00	1.910E+00	0.000E+00	0.000E+00	0.000E+00
STORY2	21-5	2.115E+00	2.115E+00	2.115E+00	0.000E+00	0.000E+00	0.000E+00
STORY2	22-4	2.124E+00	2.124E+00	2.124E+00	0.000E+00	0.000E+00	0.000E+00
STORY2	22-5	1.916E+00	1.916E+00	1.916E+00	0.000E+00	0.000E+00	0.000E+00
STORY2	23-4	2.457E+00	2.457E+00	2.457E+00	0.000E+00	0.000E+00	0.000E+00
STORY2	23-5	2.044E+00	2.044E+00	2.044E+00	0.000E+00	0.000E+00	0.000E+00
STORY2	24-4	2.169E+00	2.169E+00	2.169E+00	0.000E+00	0.000E+00	0.000E+00
STORY2	24-5	1.975E+00	1.975E+00	1.975E+00	0.000E+00	0.000E+00	0.000E+00
STORY2	25-4	2.457E+00	2.457E+00	2.457E+00	0.000E+00	0.000E+00	0.000E+00
STORY2	25-5	2.044E+00	2.044E+00	2.044E+00	0.000E+00	0.000E+00	0.000E+00
STORY2	26-4	1.972E+00	1.972E+00	1.972E+00	0.000E+00	0.000E+00	0.000E+00
STORY2	26-5	2.165E+00	2.165E+00	2.165E+00	0.000E+00	0.000E+00	0.000E+00
STORY2	27-4	5.602E+00	5.602E+00	5.602E+00	0.000E+00	0.000E+00	0.000E+00
STORY2	27-5	0.000E+00	0.000E+00	3.719E+00	0.000E+00	0.000E+00	0.000E+00
STORY2	28-4	2.147E+00	2.147E+00	2.147E+00	0.000E+00	0.000E+00	0.000E+00
STORY2	28-5	1.900E+00	1.900E+00	1.900E+00	0.000E+00	0.000E+00	0.000E+00
STORY2	27-6	3.243E+00	3.243E+00	3.243E+00	0.000E+00	0.000E+00	0.000E+00
STORY2	29-4	2.084E+00	2.084E+00	2.084E+00	0.000E+00	0.000E+00	0.000E+00
STORY2	29-5	1.733E+00	1.733E+00	1.733E+00	0.000E+00	0.000E+00	0.000E+00
STORY2	30-4	2.114E+00	2.114E+00	2.114E+00	0.000E+00	0.000E+00	0.000E+00
STORY2	30-5	1.812E+00	1.812E+00	1.812E+00	0.000E+00	0.000E+00	0.000E+00
STORY2	31-1	2.416E+00	2.416E+00	2.416E+00	0.000E+00	0.000E+00	0.000E+00

ASSEMBLED POINT MASSES

STORY	POINT	UX	UY	UZ	RX	RY	RZ
STORY2	31-2	2.175E+00	2.175E+00	2.175E+00	0.000E+00	0.000E+00	0.000E+00
STORY2	32-1	2.416E+00	2.416E+00	2.416E+00	0.000E+00	0.000E+00	0.000E+00
STORY2	32-2	2.175E+00	2.175E+00	2.175E+00	0.000E+00	0.000E+00	0.000E+00
STORY2	33-1	2.416E+00	2.416E+00	2.416E+00	0.000E+00	0.000E+00	0.000E+00
STORY2	33-2	2.175E+00	2.175E+00	2.175E+00	0.000E+00	0.000E+00	0.000E+00
STORY2	34-1	2.416E+00	2.416E+00	2.416E+00	0.000E+00	0.000E+00	0.000E+00
STORY2	34-2	2.175E+00	2.175E+00	2.175E+00	0.000E+00	0.000E+00	0.000E+00
STORY2	35-1	2.416E+00	2.416E+00	2.416E+00	0.000E+00	0.000E+00	0.000E+00
STORY2	35-2	2.175E+00	2.175E+00	2.175E+00	0.000E+00	0.000E+00	0.000E+00
STORY2	36-1	2.416E+00	2.416E+00	2.416E+00	0.000E+00	0.000E+00	0.000E+00
STORY2	36-2	2.175E+00	2.175E+00	2.175E+00	0.000E+00	0.000E+00	0.000E+00
STORY2	37-1	2.416E+00	2.416E+00	2.416E+00	0.000E+00	0.000E+00	0.000E+00
STORY2	37-2	2.175E+00	2.175E+00	2.175E+00	0.000E+00	0.000E+00	0.000E+00
STORY2	38-1	2.416E+00	2.416E+00	2.416E+00	0.000E+00	0.000E+00	0.000E+00
STORY2	38-2	2.175E+00	2.175E+00	2.175E+00	0.000E+00	0.000E+00	0.000E+00
STORY2	39-1	2.416E+00	2.416E+00	2.416E+00	0.000E+00	0.000E+00	0.000E+00
STORY2	39-2	2.175E+00	2.175E+00	2.175E+00	0.000E+00	0.000E+00	0.000E+00
STORY2	40-1	2.416E+00	2.416E+00	2.416E+00	0.000E+00	0.000E+00	0.000E+00
STORY2	40-2	2.175E+00	2.175E+00	2.175E+00	0.000E+00	0.000E+00	0.000E+00
STORY2	41-1	2.047E+00	2.047E+00	2.047E+00	0.000E+00	0.000E+00	0.000E+00
STORY2	41-2	1.696E+00	1.696E+00	1.696E+00	0.000E+00	0.000E+00	0.000E+00
STORY2	42-1	0.000E+00	0.000E+00	1.844E+00	0.000E+00	0.000E+00	0.000E+00
STORY2	42-2	3.491E+00	3.491E+00	3.491E+00	0.000E+00	0.000E+00	0.000E+00
STORY2	42-7	1.551E+00	1.551E+00	1.551E+00	0.000E+00	0.000E+00	0.000E+00
STORY2	46-2	1.981E+00	1.981E+00	1.981E+00	0.000E+00	0.000E+00	0.000E+00
STORY2	47-2	1.981E+00	1.981E+00	1.981E+00	0.000E+00	0.000E+00	0.000E+00
STORY2	43-3	2.548E+00	2.548E+00	2.548E+00	0.000E+00	0.000E+00	0.000E+00
STORY2	44-3	2.485E+00	2.485E+00	2.485E+00	0.000E+00	0.000E+00	0.000E+00
STORY2	48-2	1.856E+00	1.856E+00	1.856E+00	0.000E+00	0.000E+00	0.000E+00
STORY2	49-2	1.856E+00	1.856E+00	1.856E+00	0.000E+00	0.000E+00	0.000E+00
STORY2	49-3	2.231E+00	2.231E+00	2.231E+00	0.000E+00	0.000E+00	0.000E+00
STORY2	48-6	2.231E+00	2.231E+00	2.231E+00	0.000E+00	0.000E+00	0.000E+00
STORY2	44-6	2.061E+00	2.061E+00	2.061E+00	0.000E+00	0.000E+00	0.000E+00
STORY2	46-6	2.382E+00	2.382E+00	2.382E+00	0.000E+00	0.000E+00	0.000E+00
STORY2	47-6	2.382E+00	2.382E+00	2.382E+00	0.000E+00	0.000E+00	0.000E+00
STORY2	43-6	2.136E+00	2.136E+00	2.136E+00	0.000E+00	0.000E+00	0.000E+00
STORY2	50-2	1.258E+00	1.258E+00	1.258E+00	0.000E+00	0.000E+00	0.000E+00
STORY2	51-2	1.258E+00	1.258E+00	1.258E+00	0.000E+00	0.000E+00	0.000E+00
STORY2	52-2	1.438E+00	1.438E+00	1.438E+00	0.000E+00	0.000E+00	0.000E+00
STORY2	53-2	1.578E+00	1.578E+00	1.578E+00	0.000E+00	0.000E+00	0.000E+00
STORY2	54-2	1.358E+00	1.358E+00	1.358E+00	0.000E+00	0.000E+00	0.000E+00
STORY2	55-2	1.178E+00	1.178E+00	1.178E+00	0.000E+00	0.000E+00	0.000E+00
STORY2	55-3	0.000E+00	0.000E+00	1.827E+00	0.000E+00	0.000E+00	0.000E+00
STORY2	55-4	2.074E+00	2.074E+00	2.074E+00	0.000E+00	0.000E+00	0.000E+00
STORY2	54-6	2.281E+00	2.281E+00	2.281E+00	0.000E+00	0.000E+00	0.000E+00
STORY2	54-7	0.000E+00	0.000E+00	2.106E+00	0.000E+00	0.000E+00	0.000E+00
STORY2	53-6	1.893E+00	1.893E+00	1.893E+00	0.000E+00	0.000E+00	0.000E+00
STORY2	53-7	0.000E+00	0.000E+00	2.447E+00	0.000E+00	0.000E+00	0.000E+00
STORY2	50-6	2.214E+00	2.214E+00	2.214E+00	0.000E+00	0.000E+00	0.000E+00
STORY2	50-7	0.000E+00	0.000E+00	1.951E+00	0.000E+00	0.000E+00	0.000E+00
STORY2	51-6	2.114E+00	2.114E+00	2.114E+00	0.000E+00	0.000E+00	0.000E+00
STORY2	51-7	0.000E+00	0.000E+00	1.951E+00	0.000E+00	0.000E+00	0.000E+00
STORY2	52-6	1.658E+00	1.658E+00	1.658E+00	0.000E+00	0.000E+00	0.000E+00
STORY2	52-7	0.000E+00	0.000E+00	2.230E+00	0.000E+00	0.000E+00	0.000E+00
STORY2	79-10	6.949E-01	6.949E-01	6.949E-01	0.000E+00	0.000E+00	0.000E+00
STORY2	76-10	1.125E+00	1.125E+00	1.125E+00	0.000E+00	0.000E+00	0.000E+00
STORY2	76-11	1.125E+00	1.125E+00	1.125E+00	0.000E+00	0.000E+00	0.000E+00
STORY2	79-11	6.949E-01	6.949E-01	6.949E-01	0.000E+00	0.000E+00	0.000E+00
STORY2	76-12	1.436E+00	1.436E+00	1.436E+00	0.000E+00	0.000E+00	0.000E+00
STORY2	79-12	8.866E-01	8.866E-01	8.866E-01	0.000E+00	0.000E+00	0.000E+00
STORY2	70-10	9.753E-01	9.753E-01	9.753E-01	0.000E+00	0.000E+00	0.000E+00
STORY2	71-10	6.426E-01	6.426E-01	6.426E-01	0.000E+00	0.000E+00	0.000E+00
STORY2	67-10	1.091E+00	1.091E+00	1.091E+00	0.000E+00	0.000E+00	0.000E+00
STORY2	68-10	8.778E-01	8.778E-01	8.778E-01	0.000E+00	0.000E+00	0.000E+00
STORY2	71-12	4.916E-01	4.916E-01	4.916E-01	0.000E+00	0.000E+00	0.000E+00
STORY2	70-12	7.644E-01	7.644E-01	7.644E-01	0.000E+00	0.000E+00	0.000E+00
STORY2	71-13	4.983E-01	4.983E-01	4.983E-01	0.000E+00	0.000E+00	0.000E+00
STORY2	70-13	7.644E-01	7.644E-01	7.644E-01	0.000E+00	0.000E+00	0.000E+00
STORY2	67-12	8.391E-01	8.391E-01	8.391E-01	0.000E+00	0.000E+00	0.000E+00
STORY2	68-12	6.880E-01	6.880E-01	6.880E-01	0.000E+00	0.000E+00	0.000E+00
STORY2	67-13	8.192E-01	8.192E-01	8.192E-01	0.000E+00	0.000E+00	0.000E+00
STORY2	68-13	6.880E-01	6.880E-01	6.880E-01	0.000E+00	0.000E+00	0.000E+00
STORY2	81-9	8.646E-01	8.646E-01	8.646E-01	0.000E+00	0.000E+00	0.000E+00
STORY2	81-10	6.967E-01	6.967E-01	6.967E-01	0.000E+00	0.000E+00	0.000E+00
STORY2	81-11	1.180E+00	1.180E+00	1.180E+00	0.000E+00	0.000E+00	0.000E+00
STORY2	82-10	4.477E-01	4.477E-01	4.477E-01	0.000E+00	0.000E+00	0.000E+00
STORY2	82-12	3.035E-01	3.035E-01	3.035E-01	0.000E+00	0.000E+00	0.000E+00
STORY2	82-13	0.000E+00	0.000E+00	5.072E-01	0.000E+00	0.000E+00	0.000E+00
STORY2	69-10	9.930E-01	9.930E-01	9.930E-01	0.000E+00	0.000E+00	0.000E+00
STORY2	69-12	7.783E-01	7.783E-01	7.783E-01	0.000E+00	0.000E+00	0.000E+00
STORY2	69-13	7.783E-01	7.783E-01	7.783E-01	0.000E+00	0.000E+00	0.000E+00
STORY2	72-10	1.360E+00	1.360E+00	1.360E+00	0.000E+00	0.000E+00	0.000E+00
STORY2	72-12	1.054E+00	1.054E+00	1.054E+00	0.000E+00	0.000E+00	0.000E+00
STORY2	78-11	3.128E+00	3.128E+00	3.128E+00	0.000E+00	0.000E+00	0.000E+00
STORY2	77-10	0.000E+00	0.000E+00	1.699E+00	0.000E+00	0.000E+00	0.000E+00
STORY2	78-12	0.000E+00	0.000E+00	1.513E+00	0.000E+00	0.000E+00	0.000E+00
STORY2	78-13	1.282E+00	1.282E+00	1.282E+00	0.000E+00	0.000E+00	0.000E+00





0003543A7F908851CD669C51C48E7881

Ημ/νία έκδοσης πρόξης: 07/06/2022
 ΕΛΕΓΧΟΣ ΕΓΚΥΡΟΤΗΤΑΣ
<https://apps.tee.gr/adeiapublic/faces/searchDocFile>

ETABS v9.7.0 File:ANATOLIKH_PTERYGA_3000_ENISXISI Units:KN-m ΟαδδΥιανέιθ 23, 2010 9:52 PAGE 14

A S S E M B L E D P O I N T M A S S E S

STORY	POINT	UX	UY	UZ	RX	RY	RZ
STORY2	77-11	6.515E-01	6.515E-01	6.515E-01	0.000E+00	0.000E+00	0.000E+00
STORY2	78-14	1.226E+00	1.226E+00	1.226E+00	0.000E+00	0.000E+00	0.000E+00
STORY2	77-12	6.298E-01	6.298E-01	6.298E-01	0.000E+00	0.000E+00	0.000E+00
STORY2	77-13	7.818E-01	7.818E-01	7.818E-01	0.000E+00	0.000E+00	0.000E+00
STORY2	78-15	1.490E+00	1.490E+00	1.490E+00	0.000E+00	0.000E+00	0.000E+00
STORY2	77-14	1.607E+00	1.607E+00	1.607E+00	0.000E+00	0.000E+00	0.000E+00
STORY2	75-6	2.068E+00	2.068E+00	2.068E+00	0.000E+00	0.000E+00	0.000E+00
STORY2	73-10	2.222E+00	2.222E+00	2.222E+00	0.000E+00	0.000E+00	0.000E+00
STORY2	73-12	1.741E+00	1.741E+00	1.741E+00	0.000E+00	0.000E+00	0.000E+00
STORY2	75-8	1.620E+00	1.620E+00	1.620E+00	0.000E+00	0.000E+00	0.000E+00
STORY2	73-13	2.820E+00	2.820E+00	2.820E+00	0.000E+00	0.000E+00	0.000E+00
STORY2	75-9	1.620E+00	1.620E+00	1.620E+00	0.000E+00	0.000E+00	0.000E+00
STORY2	72-15	1.060E+00	1.060E+00	1.060E+00	0.000E+00	0.000E+00	0.000E+00
STORY2	66-10	1.702E+00	1.702E+00	1.702E+00	0.000E+00	0.000E+00	0.000E+00
STORY2	66-12	0.000E+00	0.000E+00	1.781E+00	0.000E+00	0.000E+00	0.000E+00
STORY2	66-13	1.753E+00	1.753E+00	1.753E+00	0.000E+00	0.000E+00	0.000E+00
STORY2	88-6	1.685E+00	1.685E+00	1.685E+00	0.000E+00	0.000E+00	0.000E+00
STORY2	89-6	7.553E-01	7.553E-01	7.553E-01	0.000E+00	0.000E+00	0.000E+00
STORY2	87-6	1.780E+00	1.780E+00	1.780E+00	0.000E+00	0.000E+00	0.000E+00
STORY2	87-8	8.539E-01	8.539E-01	8.539E-01	0.000E+00	0.000E+00	0.000E+00
STORY2	88-8	1.303E+00	1.303E+00	1.303E+00	0.000E+00	0.000E+00	0.000E+00
STORY2	87-9	8.989E-01	8.989E-01	8.989E-01	0.000E+00	0.000E+00	0.000E+00
STORY2	88-9	1.281E+00	1.281E+00	1.281E+00	0.000E+00	0.000E+00	0.000E+00
STORY2	97-3	1.213E+00	1.213E+00	1.213E+00	0.000E+00	0.000E+00	0.000E+00
STORY2	95-3	4.778E-01	4.778E-01	4.778E-01	0.000E+00	0.000E+00	0.000E+00
STORY2	96-3	4.778E-01	4.778E-01	4.778E-01	0.000E+00	0.000E+00	0.000E+00
STORY2	95-4	4.778E-01	4.778E-01	4.778E-01	0.000E+00	0.000E+00	0.000E+00
STORY2	96-4	4.778E-01	4.778E-01	4.778E-01	0.000E+00	0.000E+00	0.000E+00
STORY2	95-5	6.096E-01	6.096E-01	6.096E-01	0.000E+00	0.000E+00	0.000E+00
STORY2	96-5	1.216E+00	1.216E+00	1.216E+00	0.000E+00	0.000E+00	0.000E+00
STORY2	93-4	1.219E+00	1.219E+00	1.219E+00	0.000E+00	0.000E+00	0.000E+00
STORY2	93-5	1.072E+00	1.072E+00	1.072E+00	0.000E+00	0.000E+00	0.000E+00
STORY2	93-6	1.153E+00	1.153E+00	1.153E+00	0.000E+00	0.000E+00	0.000E+00
STORY2	89-8	0.000E+00	0.000E+00	1.102E+00	0.000E+00	0.000E+00	0.000E+00
STORY2	89-9	1.161E+00	1.161E+00	1.161E+00	0.000E+00	0.000E+00	0.000E+00
STORY2	99-1	2.072E+00	2.072E+00	2.072E+00	0.000E+00	0.000E+00	0.000E+00
STORY2	100-2	1.271E+00	1.271E+00	1.271E+00	0.000E+00	0.000E+00	0.000E+00
STORY2	110-3	2.532E+00	2.532E+00	2.532E+00	0.000E+00	0.000E+00	0.000E+00
STORY2	109-3	1.064E+00	1.064E+00	1.064E+00	0.000E+00	0.000E+00	0.000E+00
STORY2	110-4	1.478E+00	1.478E+00	1.478E+00	0.000E+00	0.000E+00	0.000E+00
STORY2	109-4	1.064E+00	1.064E+00	1.064E+00	0.000E+00	0.000E+00	0.000E+00
STORY2	110-5	1.910E+00	1.910E+00	1.910E+00	0.000E+00	0.000E+00	0.000E+00
STORY2	109-5	2.094E+00	2.094E+00	2.094E+00	0.000E+00	0.000E+00	0.000E+00
STORY2	108-3	1.835E+00	1.835E+00	1.835E+00	0.000E+00	0.000E+00	0.000E+00
STORY2	107-3	1.827E+00	1.827E+00	1.827E+00	0.000E+00	0.000E+00	0.000E+00
STORY2	107-5	8.614E-01	8.614E-01	8.614E-01	0.000E+00	0.000E+00	0.000E+00
STORY2	108-5	8.614E-01	8.614E-01	8.614E-01	0.000E+00	0.000E+00	0.000E+00
STORY2	107-6	8.614E-01	8.614E-01	8.614E-01	0.000E+00	0.000E+00	0.000E+00
STORY2	108-6	8.614E-01	8.614E-01	8.614E-01	0.000E+00	0.000E+00	0.000E+00
STORY2	106-3	1.832E+00	1.832E+00	1.832E+00	0.000E+00	0.000E+00	0.000E+00
STORY2	105-3	1.840E+00	1.840E+00	1.840E+00	0.000E+00	0.000E+00	0.000E+00
STORY2	105-5	8.648E-01	8.648E-01	8.648E-01	0.000E+00	0.000E+00	0.000E+00
STORY2	106-5	8.648E-01	8.648E-01	8.648E-01	0.000E+00	0.000E+00	0.000E+00
STORY2	105-6	8.648E-01	8.648E-01	8.648E-01	0.000E+00	0.000E+00	0.000E+00
STORY2	106-6	8.648E-01	8.648E-01	8.648E-01	0.000E+00	0.000E+00	0.000E+00
STORY2	104-3	1.805E+00	1.805E+00	1.805E+00	0.000E+00	0.000E+00	0.000E+00
STORY2	103-3	1.811E+00	1.811E+00	1.811E+00	0.000E+00	0.000E+00	0.000E+00
STORY2	103-5	8.371E-01	8.371E-01	8.371E-01	0.000E+00	0.000E+00	0.000E+00
STORY2	104-5	8.371E-01	8.371E-01	8.371E-01	0.000E+00	0.000E+00	0.000E+00
STORY2	103-6	8.371E-01	8.371E-01	8.371E-01	0.000E+00	0.000E+00	0.000E+00
STORY2	104-6	8.371E-01	8.371E-01	8.371E-01	0.000E+00	0.000E+00	0.000E+00
STORY2	102-3	1.505E+00	1.505E+00	1.505E+00	0.000E+00	0.000E+00	0.000E+00
STORY2	100-5	2.918E-01	2.918E-01	2.918E-01	0.000E+00	0.000E+00	0.000E+00
STORY2	101-3	7.715E-01	7.715E-01	7.715E-01	0.000E+00	0.000E+00	0.000E+00
STORY2	100-6	0.000E+00	0.000E+00	7.045E-01	0.000E+00	0.000E+00	0.000E+00
STORY2	101-4	0.000E+00	0.000E+00	2.555E+00	0.000E+00	0.000E+00	0.000E+00
STORY2	101-5	1.225E+00	1.225E+00	1.225E+00	0.000E+00	0.000E+00	0.000E+00
STORY2	99-6	0.000E+00	0.000E+00	1.665E+00	0.000E+00	0.000E+00	0.000E+00
STORY2	99-7	7.362E-01	7.362E-01	7.362E-01	0.000E+00	0.000E+00	0.000E+00
STORY2	102-5	4.797E-01	4.797E-01	4.797E-01	0.000E+00	0.000E+00	0.000E+00
STORY2	102-6	5.456E-01	5.456E-01	5.456E-01	0.000E+00	0.000E+00	0.000E+00
STORY2	112-3	1.843E+00	1.843E+00	1.843E+00	0.000E+00	0.000E+00	0.000E+00
STORY2	115-1	1.475E+00	1.475E+00	1.475E+00	0.000E+00	0.000E+00	0.000E+00
STORY2	57-5	5.899E-01	5.899E-01	5.899E-01	0.000E+00	0.000E+00	0.000E+00
STORY2	111-4	0.000E+00	0.000E+00	8.246E-01	0.000E+00	0.000E+00	0.000E+00
STORY2	127-3	0.000E+00	0.000E+00	1.223E+00	0.000E+00	0.000E+00	0.000E+00
STORY2	127-4	9.980E-01	9.980E-01	9.980E-01	0.000E+00	0.000E+00	0.000E+00
STORY2	111-5	4.990E-01	4.990E-01	4.990E-01	0.000E+00	0.000E+00	0.000E+00
STORY2	112-5	0.000E+00	0.000E+00	9.424E-01	0.000E+00	0.000E+00	0.000E+00
STORY2	112-6	9.214E-01	9.214E-01	9.214E-01	0.000E+00	0.000E+00	0.000E+00
STORY2	111-6	7.822E-01	7.822E-01	7.822E-01	0.000E+00	0.000E+00	0.000E+00
STORY2	127-5	1.564E+00	1.564E+00	1.564E+00	0.000E+00	0.000E+00	0.000E+00
STORY2	112-7	1.444E+00	1.444E+00	1.444E+00	0.000E+00	0.000E+00	0.000E+00
STORY2	111-7	1.585E+00	1.585E+00	1.585E+00	0.000E+00	0.000E+00	0.000E+00
STORY2	127-6	1.996E+00	1.996E+00	1.996E+00	0.000E+00	0.000E+00	0.000E+00
STORY2	128-3	1.277E+00	1.277E+00	1.277E+00	0.000E+00	0.000E+00	0.000E+00
STORY2	113-4	6.384E-01	6.384E-01	6.384E-01	0.000E+00	0.000E+00	0.000E+00

ASSEMBLED POINT MASSES

STORY	POINT	UX	UY	UZ	RX	RY	RZ
STORY2	113-5	6.384E-01	6.384E-01	6.384E-01	0.000E+00	0.000E+00	0.000E+00
STORY2	128-4	1.277E+00	1.277E+00	1.277E+00	0.000E+00	0.000E+00	0.000E+00
STORY2	113-6	1.407E+00	1.407E+00	1.407E+00	0.000E+00	0.000E+00	0.000E+00
STORY2	128-5	1.629E+00	1.629E+00	1.629E+00	0.000E+00	0.000E+00	0.000E+00
STORY2	129-3	1.372E+00	1.372E+00	1.372E+00	0.000E+00	0.000E+00	0.000E+00
STORY2	129-4	1.340E+00	1.340E+00	1.340E+00	0.000E+00	0.000E+00	0.000E+00
STORY2	129-5	1.709E+00	1.709E+00	1.709E+00	0.000E+00	0.000E+00	0.000E+00
STORY2	130-3	0.000E+00	0.000E+00	1.943E+00	0.000E+00	0.000E+00	0.000E+00
STORY2	130-4	1.277E+00	1.277E+00	1.277E+00	0.000E+00	0.000E+00	0.000E+00
STORY2	130-5	7.823E-01	7.823E-01	7.823E-01	0.000E+00	0.000E+00	0.000E+00
STORY2	130-6	1.629E+00	1.629E+00	1.629E+00	0.000E+00	0.000E+00	0.000E+00
STORY2	114-4	0.000E+00	0.000E+00	6.631E-01	0.000E+00	0.000E+00	0.000E+00
STORY2	114-5	3.672E-01	3.672E-01	3.672E-01	0.000E+00	0.000E+00	0.000E+00
STORY2	114-6	5.757E-01	5.757E-01	5.757E-01	0.000E+00	0.000E+00	0.000E+00
STORY2	114-7	1.322E+00	1.322E+00	1.322E+00	0.000E+00	0.000E+00	0.000E+00
STORY2	126-3	1.348E+00	1.348E+00	1.348E+00	0.000E+00	0.000E+00	0.000E+00
STORY2	125-3	2.796E+00	2.796E+00	2.796E+00	0.000E+00	0.000E+00	0.000E+00
STORY2	125-5	2.192E+00	2.192E+00	2.192E+00	0.000E+00	0.000E+00	0.000E+00
STORY2	126-5	5.918E-01	5.918E-01	5.918E-01	0.000E+00	0.000E+00	0.000E+00
STORY2	125-6	2.192E+00	2.192E+00	2.192E+00	0.000E+00	0.000E+00	0.000E+00
STORY2	126-6	5.918E-01	5.918E-01	5.918E-01	0.000E+00	0.000E+00	0.000E+00
STORY2	124-3	8.620E-01	8.620E-01	8.620E-01	0.000E+00	0.000E+00	0.000E+00
STORY2	124-4	8.620E-01	8.620E-01	8.620E-01	0.000E+00	0.000E+00	0.000E+00
STORY2	124-5	1.696E+00	1.696E+00	1.696E+00	0.000E+00	0.000E+00	0.000E+00
STORY2	123-3	1.487E+00	1.487E+00	1.487E+00	0.000E+00	0.000E+00	0.000E+00
STORY2	122-3	1.480E+00	1.480E+00	1.480E+00	0.000E+00	0.000E+00	0.000E+00
STORY2	122-5	6.978E-01	6.978E-01	6.978E-01	0.000E+00	0.000E+00	0.000E+00
STORY2	123-5	6.978E-01	6.978E-01	6.978E-01	0.000E+00	0.000E+00	0.000E+00
STORY2	122-6	6.978E-01	6.978E-01	6.978E-01	0.000E+00	0.000E+00	0.000E+00
STORY2	123-6	6.978E-01	6.978E-01	6.978E-01	0.000E+00	0.000E+00	0.000E+00
STORY2	121-3	1.484E+00	1.484E+00	1.484E+00	0.000E+00	0.000E+00	0.000E+00
STORY2	120-3	1.491E+00	1.491E+00	1.491E+00	0.000E+00	0.000E+00	0.000E+00
STORY2	120-5	7.007E-01	7.007E-01	7.007E-01	0.000E+00	0.000E+00	0.000E+00
STORY2	121-5	7.007E-01	7.007E-01	7.007E-01	0.000E+00	0.000E+00	0.000E+00
STORY2	120-6	7.007E-01	7.007E-01	7.007E-01	0.000E+00	0.000E+00	0.000E+00
STORY2	121-6	7.007E-01	7.007E-01	7.007E-01	0.000E+00	0.000E+00	0.000E+00
STORY2	119-3	1.462E+00	1.462E+00	1.462E+00	0.000E+00	0.000E+00	0.000E+00
STORY2	118-3	1.467E+00	1.467E+00	1.467E+00	0.000E+00	0.000E+00	0.000E+00
STORY2	118-5	6.782E-01	6.782E-01	6.782E-01	0.000E+00	0.000E+00	0.000E+00
STORY2	119-5	6.782E-01	6.782E-01	6.782E-01	0.000E+00	0.000E+00	0.000E+00
STORY2	118-6	6.782E-01	6.782E-01	6.782E-01	0.000E+00	0.000E+00	0.000E+00
STORY2	119-6	6.782E-01	6.782E-01	6.782E-01	0.000E+00	0.000E+00	0.000E+00
STORY2	117-3	1.219E+00	1.219E+00	1.219E+00	0.000E+00	0.000E+00	0.000E+00
STORY2	115-6	5.169E-01	5.169E-01	5.169E-01	0.000E+00	0.000E+00	0.000E+00
STORY2	115-7	0.000E+00	0.000E+00	9.829E-01	0.000E+00	0.000E+00	0.000E+00
STORY2	115-8	5.965E-01	5.965E-01	5.965E-01	0.000E+00	0.000E+00	0.000E+00
STORY2	116-3	2.364E-01	2.364E-01	2.364E-01	0.000E+00	0.000E+00	0.000E+00
STORY2	131-3	6.250E-01	6.250E-01	6.250E-01	0.000E+00	0.000E+00	0.000E+00
STORY2	116-4	0.000E+00	0.000E+00	6.178E-01	0.000E+00	0.000E+00	0.000E+00
STORY2	131-4	0.000E+00	0.000E+00	2.383E+00	0.000E+00	0.000E+00	0.000E+00
STORY2	116-5	5.691E-01	5.691E-01	5.691E-01	0.000E+00	0.000E+00	0.000E+00
STORY2	131-5	9.927E-01	9.927E-01	9.927E-01	0.000E+00	0.000E+00	0.000E+00
STORY2	117-5	3.886E-01	3.886E-01	3.886E-01	0.000E+00	0.000E+00	0.000E+00
STORY2	117-6	4.420E-01	4.420E-01	4.420E-01	0.000E+00	0.000E+00	0.000E+00
STORY2	132-1	2.027E+00	2.027E+00	2.027E+00	0.000E+00	0.000E+00	0.000E+00
STORY2	132-3	1.621E+00	1.621E+00	1.621E+00	0.000E+00	0.000E+00	0.000E+00
STORY2	132-4	9.818E-01	9.818E-01	9.818E-01	0.000E+00	0.000E+00	0.000E+00
STORY2	132-5	0.000E+00	0.000E+00	1.335E+00	0.000E+00	0.000E+00	0.000E+00
STORY2	133-1	1.676E+00	1.676E+00	1.676E+00	0.000E+00	0.000E+00	0.000E+00
STORY2	133-3	1.313E+00	1.313E+00	1.313E+00	0.000E+00	0.000E+00	0.000E+00
STORY2	133-4	8.379E-01	8.379E-01	8.379E-01	0.000E+00	0.000E+00	0.000E+00
STORY2	133-5	0.000E+00	0.000E+00	1.094E+00	0.000E+00	0.000E+00	0.000E+00
STORY2	134-1	1.148E+00	1.148E+00	1.148E+00	0.000E+00	0.000E+00	0.000E+00
STORY2	134-3	8.837E-01	8.837E-01	8.837E-01	0.000E+00	0.000E+00	0.000E+00
STORY2	134-4	5.428E-01	5.428E-01	5.428E-01	0.000E+00	0.000E+00	0.000E+00
STORY2	134-5	0.000E+00	0.000E+00	7.359E-01	0.000E+00	0.000E+00	0.000E+00
STORY2	135-1	1.690E+00	1.690E+00	1.690E+00	0.000E+00	0.000E+00	0.000E+00
STORY2	135-3	1.324E+00	1.324E+00	1.324E+00	0.000E+00	0.000E+00	0.000E+00
STORY2	135-4	8.448E-01	8.448E-01	8.448E-01	0.000E+00	0.000E+00	0.000E+00
STORY2	135-5	0.000E+00	0.000E+00	1.103E+00	0.000E+00	0.000E+00	0.000E+00
STORY2	136-1	1.690E+00	1.690E+00	1.690E+00	0.000E+00	0.000E+00	0.000E+00
STORY2	136-3	1.324E+00	1.324E+00	1.324E+00	0.000E+00	0.000E+00	0.000E+00
STORY2	136-4	8.448E-01	8.448E-01	8.448E-01	0.000E+00	0.000E+00	0.000E+00
STORY2	136-5	0.000E+00	0.000E+00	1.103E+00	0.000E+00	0.000E+00	0.000E+00
STORY2	137-1	1.769E+00	1.769E+00	1.769E+00	0.000E+00	0.000E+00	0.000E+00
STORY2	137-3	6.621E-01	6.621E-01	6.621E-01	0.000E+00	0.000E+00	0.000E+00
STORY2	137-4	4.224E-01	4.224E-01	4.224E-01	0.000E+00	0.000E+00	0.000E+00
STORY2	137-5	0.000E+00	0.000E+00	9.478E-01	0.000E+00	0.000E+00	0.000E+00
STORY2	138-1	1.938E+00	1.938E+00	1.938E+00	0.000E+00	0.000E+00	0.000E+00
STORY2	139-1	2.041E+00	2.041E+00	2.041E+00	0.000E+00	0.000E+00	0.000E+00
STORY2	139-3	1.565E+00	1.565E+00	1.565E+00	0.000E+00	0.000E+00	0.000E+00
STORY2	138-5	7.945E-01	7.945E-01	7.945E-01	0.000E+00	0.000E+00	0.000E+00
STORY2	139-4	9.539E-01	9.539E-01	9.539E-01	0.000E+00	0.000E+00	0.000E+00
STORY2	138-6	5.069E-01	5.069E-01	5.069E-01	0.000E+00	0.000E+00	0.000E+00
STORY2	139-5	0.000E+00	0.000E+00	1.303E+00	0.000E+00	0.000E+00	0.000E+00
STORY2	138-7	0.000E+00	0.000E+00	1.058E+00	0.000E+00	0.000E+00	0.000E+00
STORY2	140-1	1.071E+00	1.071E+00	1.071E+00	0.000E+00	0.000E+00	0.000E+00



A S S E M B L E D P O I N T M A S S E S

STORY	POINT	UX	UY	UZ	RX	RY	RZ
STORY2	140-3	1.211E+00	1.211E+00	1.211E+00	0.000E+00	0.000E+00	0.000E+00
STORY2	140-4	9.501E-01	9.501E-01	9.501E-01	0.000E+00	0.000E+00	0.000E+00
STORY2	140-5	0.000E+00	0.000E+00	2.538E+00	0.000E+00	0.000E+00	0.000E+00
STORY2	141-1	7.381E-01	7.381E-01	7.381E-01	0.000E+00	0.000E+00	0.000E+00
STORY2	141-2	8.054E-01	8.054E-01	8.054E-01	0.000E+00	0.000E+00	0.000E+00
STORY2	141-3	0.000E+00	0.000E+00	1.283E+00	0.000E+00	0.000E+00	0.000E+00
STORY2	141-6	5.074E-01	5.074E-01	5.074E-01	0.000E+00	0.000E+00	0.000E+00
STORY2	142-1	0.000E+00	0.000E+00	6.449E-01	0.000E+00	0.000E+00	0.000E+00
STORY2	142-2	9.079E-01	9.079E-01	9.079E-01	0.000E+00	0.000E+00	0.000E+00
STORY2	143-1	1.091E+00	1.091E+00	1.091E+00	0.000E+00	0.000E+00	0.000E+00
STORY2	143-2	0.000E+00	0.000E+00	7.722E-01	0.000E+00	0.000E+00	0.000E+00
STORY2	142-3	1.862E+00	1.862E+00	1.862E+00	0.000E+00	0.000E+00	0.000E+00
STORY2	143-3	2.289E+00	2.289E+00	2.289E+00	0.000E+00	0.000E+00	0.000E+00
STORY2	144-1	0.000E+00	0.000E+00	9.489E-01	0.000E+00	0.000E+00	0.000E+00
STORY2	145-1	6.585E-01	6.585E-01	6.585E-01	0.000E+00	0.000E+00	0.000E+00
STORY2	145-2	1.823E+00	1.823E+00	1.823E+00	0.000E+00	0.000E+00	0.000E+00
STORY2	146-1	1.464E+00	1.464E+00	1.464E+00	0.000E+00	0.000E+00	0.000E+00
STORY2	147-1	0.000E+00	0.000E+00	8.633E-01	0.000E+00	0.000E+00	0.000E+00
STORY2	147-2	8.515E-01	8.515E-01	8.515E-01	0.000E+00	0.000E+00	0.000E+00
STORY2	146-3	5.477E-01	5.477E-01	5.477E-01	0.000E+00	0.000E+00	0.000E+00
STORY2	146-4	0.000E+00	0.000E+00	5.801E-01	0.000E+00	0.000E+00	0.000E+00
STORY2	147-3	1.750E+00	1.750E+00	1.750E+00	0.000E+00	0.000E+00	0.000E+00
STORY2	148-1	0.000E+00	0.000E+00	6.411E-01	0.000E+00	0.000E+00	0.000E+00
STORY2	148-2	6.211E-01	6.211E-01	6.211E-01	0.000E+00	0.000E+00	0.000E+00
STORY2	148-3	1.265E+00	1.265E+00	1.265E+00	0.000E+00	0.000E+00	0.000E+00
STORY2	149-1	0.000E+00	0.000E+00	7.479E-01	0.000E+00	0.000E+00	0.000E+00
STORY2	149-2	4.192E-01	4.192E-01	4.192E-01	0.000E+00	0.000E+00	0.000E+00
STORY2	149-3	2.439E-01	2.439E-01	2.439E-01	0.000E+00	0.000E+00	0.000E+00
STORY2	150-1	7.853E-01	7.853E-01	7.853E-01	0.000E+00	0.000E+00	0.000E+00
STORY2	150-2	1.549E+00	1.549E+00	1.549E+00	0.000E+00	0.000E+00	0.000E+00
STORY2	151-1	5.153E-01	5.153E-01	5.153E-01	0.000E+00	0.000E+00	0.000E+00
STORY2	151-2	5.948E-01	5.948E-01	5.948E-01	0.000E+00	0.000E+00	0.000E+00
STORY2	152-1	7.827E-01	7.827E-01	7.827E-01	0.000E+00	0.000E+00	0.000E+00
STORY2	152-2	1.609E+00	1.609E+00	1.609E+00	0.000E+00	0.000E+00	0.000E+00
STORY2	153-1	4.889E-01	4.889E-01	4.889E-01	0.000E+00	0.000E+00	0.000E+00
STORY2	153-2	1.005E+00	1.005E+00	1.005E+00	0.000E+00	0.000E+00	0.000E+00
STORY2	154-1	0.000E+00	0.000E+00	1.066E+00	0.000E+00	0.000E+00	0.000E+00
STORY2	150-4	0.000E+00	0.000E+00	9.347E-01	0.000E+00	0.000E+00	0.000E+00
STORY2	152-4	0.000E+00	0.000E+00	7.775E-01	0.000E+00	0.000E+00	0.000E+00
STORY2	153-4	0.000E+00	0.000E+00	9.716E-01	0.000E+00	0.000E+00	0.000E+00
STORY2	155-1	0.000E+00	0.000E+00	8.255E-01	0.000E+00	0.000E+00	0.000E+00
STORY2	156-1	1.883E+00	1.883E+00	1.883E+00	0.000E+00	0.000E+00	0.000E+00
STORY2	156-3	1.476E+00	1.476E+00	1.476E+00	0.000E+00	0.000E+00	0.000E+00
STORY2	156-4	1.476E+00	1.476E+00	1.476E+00	0.000E+00	0.000E+00	0.000E+00
STORY2	157-1	1.883E+00	1.883E+00	1.883E+00	0.000E+00	0.000E+00	0.000E+00
STORY2	157-3	1.476E+00	1.476E+00	1.476E+00	0.000E+00	0.000E+00	0.000E+00
STORY2	157-4	1.476E+00	1.476E+00	1.476E+00	0.000E+00	0.000E+00	0.000E+00
STORY2	158-1	1.883E+00	1.883E+00	1.883E+00	0.000E+00	0.000E+00	0.000E+00
STORY2	158-3	1.476E+00	1.476E+00	1.476E+00	0.000E+00	0.000E+00	0.000E+00
STORY2	158-4	1.476E+00	1.476E+00	1.476E+00	0.000E+00	0.000E+00	0.000E+00
STORY2	159-1	1.883E+00	1.883E+00	1.883E+00	0.000E+00	0.000E+00	0.000E+00
STORY2	159-3	1.476E+00	1.476E+00	1.476E+00	0.000E+00	0.000E+00	0.000E+00
STORY2	159-4	1.476E+00	1.476E+00	1.476E+00	0.000E+00	0.000E+00	0.000E+00
STORY2	160-1	1.925E+00	1.925E+00	1.925E+00	0.000E+00	0.000E+00	0.000E+00
STORY2	160-3	1.476E+00	1.476E+00	1.476E+00	0.000E+00	0.000E+00	0.000E+00
STORY2	160-4	1.433E+00	1.433E+00	1.433E+00	0.000E+00	0.000E+00	0.000E+00
STORY2	161-1	1.026E+00	1.026E+00	1.026E+00	0.000E+00	0.000E+00	0.000E+00
STORY2	161-3	1.114E+00	1.114E+00	1.114E+00	0.000E+00	0.000E+00	0.000E+00
STORY2	161-4	1.475E+00	1.475E+00	1.475E+00	0.000E+00	0.000E+00	0.000E+00
STORY2	162-1	1.189E+00	1.189E+00	1.189E+00	0.000E+00	0.000E+00	0.000E+00
STORY2	162-2	7.901E-01	7.901E-01	7.901E-01	0.000E+00	0.000E+00	0.000E+00
STORY2	162-5	5.759E-01	5.759E-01	5.759E-01	0.000E+00	0.000E+00	0.000E+00
STORY2	163-1	1.950E+00	1.950E+00	1.950E+00	0.000E+00	0.000E+00	0.000E+00
STORY2	163-3	0.000E+00	0.000E+00	1.377E+00	0.000E+00	0.000E+00	0.000E+00
STORY2	164-1	2.248E+00	2.248E+00	2.248E+00	0.000E+00	0.000E+00	0.000E+00
STORY2	165-1	0.000E+00	0.000E+00	1.006E+00	0.000E+00	0.000E+00	0.000E+00
STORY2	166-1	1.984E+00	1.984E+00	1.984E+00	0.000E+00	0.000E+00	0.000E+00
STORY2	166-3	0.000E+00	0.000E+00	1.466E+00	0.000E+00	0.000E+00	0.000E+00
STORY2	167-1	0.000E+00	0.000E+00	1.125E+00	0.000E+00	0.000E+00	0.000E+00
STORY2	168-1	1.030E+00	1.030E+00	1.030E+00	0.000E+00	0.000E+00	0.000E+00
STORY2	168-3	0.000E+00	0.000E+00	1.430E+00	0.000E+00	0.000E+00	0.000E+00
STORY2	163-5	8.275E-01	8.275E-01	8.275E-01	0.000E+00	0.000E+00	0.000E+00
STORY2	165-2	1.787E-01	1.787E-01	1.787E-01	0.000E+00	0.000E+00	0.000E+00
STORY2	166-5	9.731E-01	9.731E-01	9.731E-01	0.000E+00	0.000E+00	0.000E+00
STORY2	167-2	3.244E-01	3.244E-01	3.244E-01	0.000E+00	0.000E+00	0.000E+00
STORY2	168-5	1.297E+00	1.297E+00	1.297E+00	0.000E+00	0.000E+00	0.000E+00
STORY2	153-6	1.196E+00	1.196E+00	1.196E+00	0.000E+00	0.000E+00	0.000E+00
STORY2	169-3	4.862E-01	4.862E-01	4.862E-01	0.000E+00	0.000E+00	0.000E+00
STORY2	169-4	5.165E-01	5.165E-01	5.165E-01	0.000E+00	0.000E+00	0.000E+00
STORY2	169-5	5.709E-01	5.709E-01	5.709E-01	0.000E+00	0.000E+00	0.000E+00
STORY2	83-9	5.221E-01	5.221E-01	5.221E-01	0.000E+00	0.000E+00	0.000E+00
STORY2	171-1	6.991E-01	6.991E-01	6.991E-01	0.000E+00	0.000E+00	0.000E+00
STORY2	171-2	7.170E-01	7.170E-01	7.170E-01	0.000E+00	0.000E+00	0.000E+00
STORY2	83-10	5.975E-01	5.975E-01	5.975E-01	0.000E+00	0.000E+00	0.000E+00
STORY2	172-1	3.585E-01	3.585E-01	3.585E-01	0.000E+00	0.000E+00	0.000E+00
STORY2	172-2	3.585E-01	3.585E-01	3.585E-01	0.000E+00	0.000E+00	0.000E+00
STORY2	171-3	7.170E-01	7.170E-01	7.170E-01	0.000E+00	0.000E+00	0.000E+00

ASSEMBLED POINT MASSES

STORY	POINT	UX	UY	UZ	RX	RY	RZ
STORY2	83-11	5.975E-01	5.975E-01	5.975E-01	0.000E+00	0.000E+00	0.000E+00
STORY2	172-3	3.585E-01	3.585E-01	3.585E-01	0.000E+00	0.000E+00	0.000E+00
STORY2	83-12	0.000E+00	0.000E+00	1.639E+00	0.000E+00	0.000E+00	0.000E+00
STORY2	173-2	8.843E-01	8.843E-01	8.843E-01	0.000E+00	0.000E+00	0.000E+00
STORY2	174-2	4.421E-01	4.421E-01	4.421E-01	0.000E+00	0.000E+00	0.000E+00
STORY2	173-3	4.302E-01	4.302E-01	4.302E-01	0.000E+00	0.000E+00	0.000E+00
STORY2	174-3	2.151E-01	2.151E-01	2.151E-01	0.000E+00	0.000E+00	0.000E+00
STORY2	173-4	6.094E-01	6.094E-01	6.094E-01	0.000E+00	0.000E+00	0.000E+00
STORY2	174-4	3.047E-01	3.047E-01	3.047E-01	0.000E+00	0.000E+00	0.000E+00
STORY2	175-1	0.000E+00	0.000E+00	1.559E+00	0.000E+00	0.000E+00	0.000E+00
STORY2	170-9	4.966E-01	4.966E-01	4.966E-01	0.000E+00	0.000E+00	0.000E+00
STORY2	170-10	3.914E-01	3.914E-01	3.914E-01	0.000E+00	0.000E+00	0.000E+00
STORY2	170-11	4.860E-01	4.860E-01	4.860E-01	0.000E+00	0.000E+00	0.000E+00
STORY2	143-8	1.126E+00	1.126E+00	1.126E+00	0.000E+00	0.000E+00	0.000E+00
STORY2	142-8	9.930E-01	9.930E-01	9.930E-01	0.000E+00	0.000E+00	0.000E+00
STORY2	144-4	8.256E-01	8.256E-01	8.256E-01	0.000E+00	0.000E+00	0.000E+00
STORY2	146-8	8.905E-01	8.905E-01	8.905E-01	0.000E+00	0.000E+00	0.000E+00
STORY2	147-8	1.292E+00	1.292E+00	1.292E+00	0.000E+00	0.000E+00	0.000E+00
STORY2	148-8	8.307E-01	8.307E-01	8.307E-01	0.000E+00	0.000E+00	0.000E+00
STORY2	154-4	9.070E-01	9.070E-01	9.070E-01	0.000E+00	0.000E+00	0.000E+00
STORY2	150-8	1.359E+00	1.359E+00	1.359E+00	0.000E+00	0.000E+00	0.000E+00
STORY2	152-8	1.188E+00	1.188E+00	1.188E+00	0.000E+00	0.000E+00	0.000E+00
STORY2	149-6	3.789E-01	3.789E-01	3.789E-01	0.000E+00	0.000E+00	0.000E+00
STORY2	155-7	7.391E-01	7.391E-01	7.391E-01	0.000E+00	0.000E+00	0.000E+00
STORY2	176-1	9.612E-01	9.612E-01	9.612E-01	0.000E+00	0.000E+00	0.000E+00
STORY2	176-2	1.193E+00	1.193E+00	1.193E+00	0.000E+00	0.000E+00	0.000E+00
STORY2	177-1	8.432E-01	8.432E-01	8.432E-01	0.000E+00	0.000E+00	0.000E+00
STORY2	177-2	6.792E-01	6.792E-01	6.792E-01	0.000E+00	0.000E+00	0.000E+00
STORY2	176-3	2.453E+00	2.453E+00	2.453E+00	0.000E+00	0.000E+00	0.000E+00
STORY2	177-3	1.733E+00	1.733E+00	1.733E+00	0.000E+00	0.000E+00	0.000E+00
STORY2	178-1	9.612E-01	9.612E-01	9.612E-01	0.000E+00	0.000E+00	0.000E+00
STORY2	178-2	1.193E+00	1.193E+00	1.193E+00	0.000E+00	0.000E+00	0.000E+00
STORY2	178-3	2.453E+00	2.453E+00	2.453E+00	0.000E+00	0.000E+00	0.000E+00
STORY2	179-1	9.016E-01	9.016E-01	9.016E-01	0.000E+00	0.000E+00	0.000E+00
STORY2	179-2	1.068E+00	1.068E+00	1.068E+00	0.000E+00	0.000E+00	0.000E+00
STORY2	179-3	2.153E+00	2.153E+00	2.153E+00	0.000E+00	0.000E+00	0.000E+00
STORY2	180-1	8.545E-01	8.545E-01	8.545E-01	0.000E+00	0.000E+00	0.000E+00
STORY2	180-2	9.168E-01	9.168E-01	9.168E-01	0.000E+00	0.000E+00	0.000E+00
STORY2	180-3	8.856E-01	8.856E-01	8.856E-01	0.000E+00	0.000E+00	0.000E+00
STORY2	181-1	8.466E-01	8.466E-01	8.466E-01	0.000E+00	0.000E+00	0.000E+00
STORY2	181-2	9.088E-01	9.088E-01	9.088E-01	0.000E+00	0.000E+00	0.000E+00
STORY2	182-1	1.071E+00	1.071E+00	1.071E+00	0.000E+00	0.000E+00	0.000E+00
STORY2	182-2	2.138E+00	2.138E+00	2.138E+00	0.000E+00	0.000E+00	0.000E+00
STORY2	181-3	8.705E-01	8.705E-01	8.705E-01	0.000E+00	0.000E+00	0.000E+00
STORY2	183-1	0.000E+00	0.000E+00	2.247E-01	0.000E+00	0.000E+00	0.000E+00
STORY2	183-2	1.350E+00	1.350E+00	1.350E+00	0.000E+00	0.000E+00	0.000E+00
STORY2	184-1	2.251E-01	2.251E-01	2.251E-01	0.000E+00	0.000E+00	0.000E+00
STORY2	183-3	2.753E+00	2.753E+00	2.753E+00	0.000E+00	0.000E+00	0.000E+00
STORY2	185-1	0.000E+00	0.000E+00	4.879E-01	0.000E+00	0.000E+00	0.000E+00
STORY2	182-4	5.460E-01	5.460E-01	5.460E-01	0.000E+00	0.000E+00	0.000E+00
STORY2	177-8	1.194E+00	1.194E+00	1.194E+00	0.000E+00	0.000E+00	0.000E+00
STORY2	176-8	1.690E+00	1.690E+00	1.690E+00	0.000E+00	0.000E+00	0.000E+00
STORY2	178-8	1.690E+00	1.690E+00	1.690E+00	0.000E+00	0.000E+00	0.000E+00
STORY2	179-8	1.513E+00	1.513E+00	1.513E+00	0.000E+00	0.000E+00	0.000E+00
STORY2	180-8	6.675E-01	6.675E-01	6.675E-01	0.000E+00	0.000E+00	0.000E+00
STORY2	181-8	6.561E-01	6.561E-01	6.561E-01	0.000E+00	0.000E+00	0.000E+00
STORY2	182-8	9.090E-01	9.090E-01	9.090E-01	0.000E+00	0.000E+00	0.000E+00
STORY2	185-4	5.627E-01	5.627E-01	5.627E-01	0.000E+00	0.000E+00	0.000E+00
STORY2	184-7	2.529E-01	2.529E-01	2.529E-01	0.000E+00	0.000E+00	0.000E+00
STORY2	186-1	3.379E-01	3.379E-01	3.379E-01	0.000E+00	0.000E+00	0.000E+00
STORY2	186-2	6.945E-01	6.945E-01	6.945E-01	0.000E+00	0.000E+00	0.000E+00
STORY2	187-1	2.482E-01	2.482E-01	2.482E-01	0.000E+00	0.000E+00	0.000E+00
STORY2	187-2	5.102E-01	5.102E-01	5.102E-01	0.000E+00	0.000E+00	0.000E+00
STORY2	186-4	0.000E+00	0.000E+00	5.129E-01	0.000E+00	0.000E+00	0.000E+00
STORY2	187-4	0.000E+00	0.000E+00	2.942E-01	0.000E+00	0.000E+00	0.000E+00
STORY2	188-3	2.152E-01	2.152E-01	2.152E-01	0.000E+00	0.000E+00	0.000E+00
STORY2	189-3	2.350E-01	2.350E-01	2.350E-01	0.000E+00	0.000E+00	0.000E+00
STORY2	187-8	2.773E-01	2.773E-01	2.773E-01	0.000E+00	0.000E+00	0.000E+00
STORY2	190-1	4.373E-01	4.373E-01	4.373E-01	0.000E+00	0.000E+00	0.000E+00
STORY2	190-3	1.720E-01	1.720E-01	1.720E-01	0.000E+00	0.000E+00	0.000E+00
STORY2	190-4	0.000E+00	0.000E+00	4.148E-01	0.000E+00	0.000E+00	0.000E+00
STORY2	87-11	0.000E+00	0.000E+00	1.675E-01	0.000E+00	0.000E+00	0.000E+00
STORY2	191-1	6.147E-01	6.147E-01	6.147E-01	0.000E+00	0.000E+00	0.000E+00
STORY2	192-1	6.147E-01	6.147E-01	6.147E-01	0.000E+00	0.000E+00	0.000E+00
STORY2	191-3	2.617E-01	2.617E-01	2.617E-01	0.000E+00	0.000E+00	0.000E+00
STORY2	192-3	2.582E-01	2.582E-01	2.582E-01	0.000E+00	0.000E+00	0.000E+00
STORY2	191-4	0.000E+00	0.000E+00	4.564E-01	0.000E+00	0.000E+00	0.000E+00
STORY2	192-4	0.000E+00	0.000E+00	5.458E-01	0.000E+00	0.000E+00	0.000E+00
STORY2	193-1	4.373E-01	4.373E-01	4.373E-01	0.000E+00	0.000E+00	0.000E+00
STORY2	193-3	1.685E-01	1.685E-01	1.685E-01	0.000E+00	0.000E+00	0.000E+00
STORY2	193-4	0.000E+00	0.000E+00	4.318E-01	0.000E+00	0.000E+00	0.000E+00
STORY2	194-1	4.817E-01	4.817E-01	4.817E-01	0.000E+00	0.000E+00	0.000E+00
STORY2	195-1	4.817E-01	4.817E-01	4.817E-01	0.000E+00	0.000E+00	0.000E+00
STORY2	194-3	1.935E-01	1.935E-01	1.935E-01	0.000E+00	0.000E+00	0.000E+00
STORY2	195-3	1.935E-01	1.935E-01	1.935E-01	0.000E+00	0.000E+00	0.000E+00
STORY2	194-4	0.000E+00	0.000E+00	4.587E-01	0.000E+00	0.000E+00	0.000E+00
STORY2	195-4	0.000E+00	0.000E+00	4.587E-01	0.000E+00	0.000E+00	0.000E+00



A S S E M B L E D P O I N T M A S S E S

STORY	POINT	UX	UY	UZ	RX	RY	RZ
STORY2	190-7	2.582E-01	2.582E-01	2.582E-01	0.000E+00	0.000E+00	0.000E+00
STORY2	193-6	3.208E-01	3.208E-01	3.208E-01	0.000E+00	0.000E+00	0.000E+00
STORY2	196-1	3.526E-01	3.526E-01	3.526E-01	0.000E+00	0.000E+00	0.000E+00
STORY2	197-1	3.416E-01	3.416E-01	3.416E-01	0.000E+00	0.000E+00	0.000E+00
STORY2	196-2	0.000E+00	0.000E+00	1.280E-01	0.000E+00	0.000E+00	0.000E+00
STORY2	194-7	3.623E-01	3.623E-01	3.623E-01	0.000E+00	0.000E+00	0.000E+00
STORY2	195-6	2.888E-01	2.888E-01	2.888E-01	0.000E+00	0.000E+00	0.000E+00
STORY2	198-1	9.827E-01	9.827E-01	9.827E-01	0.000E+00	0.000E+00	0.000E+00
STORY2	200-1	7.509E-01	7.509E-01	7.509E-01	0.000E+00	0.000E+00	0.000E+00
STORY2	201-1	8.017E-01	8.017E-01	8.017E-01	0.000E+00	0.000E+00	0.000E+00
STORY2	201-3	3.900E-01	3.900E-01	3.900E-01	0.000E+00	0.000E+00	0.000E+00
STORY2	200-3	1.434E-01	1.434E-01	1.434E-01	0.000E+00	0.000E+00	0.000E+00
STORY2	198-3	4.781E-01	4.781E-01	4.781E-01	0.000E+00	0.000E+00	0.000E+00
STORY2	198-4	3.851E-01	3.851E-01	3.851E-01	0.000E+00	0.000E+00	0.000E+00
STORY2	199-1	9.319E-01	9.319E-01	9.319E-01	0.000E+00	0.000E+00	0.000E+00
STORY2	199-3	2.315E-01	2.315E-01	2.315E-01	0.000E+00	0.000E+00	0.000E+00
STORY2	199-4	1.865E-01	1.865E-01	1.865E-01	0.000E+00	0.000E+00	0.000E+00
STORY2	201-4	3.142E-01	3.142E-01	3.142E-01	0.000E+00	0.000E+00	0.000E+00
STORY2	200-4	1.155E-01	1.155E-01	1.155E-01	0.000E+00	0.000E+00	0.000E+00
STORY2	198-7	6.955E-01	6.955E-01	6.955E-01	0.000E+00	0.000E+00	0.000E+00
STORY2	199-7	3.279E-01	3.279E-01	3.279E-01	0.000E+00	0.000E+00	0.000E+00
STORY2	201-7	5.525E-01	5.525E-01	5.525E-01	0.000E+00	0.000E+00	0.000E+00
STORY2	200-8	2.032E-01	2.032E-01	2.032E-01	0.000E+00	0.000E+00	0.000E+00
STORY2	206-1	0.000E+00	0.000E+00	6.980E-01	0.000E+00	0.000E+00	0.000E+00
STORY2	207-1	0.000E+00	0.000E+00	1.823E-01	0.000E+00	0.000E+00	0.000E+00
STORY2	208-1	0.000E+00	0.000E+00	8.044E-01	0.000E+00	0.000E+00	0.000E+00
STORY2	209-1	0.000E+00	0.000E+00	2.101E-01	0.000E+00	0.000E+00	0.000E+00
STORY2	210-1	0.000E+00	0.000E+00	9.346E-01	0.000E+00	0.000E+00	0.000E+00
STORY2	211-1	0.000E+00	0.000E+00	2.441E-01	0.000E+00	0.000E+00	0.000E+00
STORY2	212-1	0.000E+00	0.000E+00	8.518E-01	0.000E+00	0.000E+00	0.000E+00
STORY2	213-1	0.000E+00	0.000E+00	2.225E-01	0.000E+00	0.000E+00	0.000E+00
STORY2	214-1	0.000E+00	0.000E+00	7.453E-01	0.000E+00	0.000E+00	0.000E+00
STORY2	215-1	0.000E+00	0.000E+00	1.947E-01	0.000E+00	0.000E+00	0.000E+00
STORY2	216-1	0.000E+00	0.000E+00	1.141E+00	0.000E+00	0.000E+00	0.000E+00
STORY2	217-1	0.000E+00	0.000E+00	1.315E+00	0.000E+00	0.000E+00	0.000E+00
STORY2	218-1	0.000E+00	0.000E+00	1.528E+00	0.000E+00	0.000E+00	0.000E+00
STORY2	219-1	0.000E+00	0.000E+00	1.393E+00	0.000E+00	0.000E+00	0.000E+00
STORY2	220-1	0.000E+00	0.000E+00	1.219E+00	0.000E+00	0.000E+00	0.000E+00
STORY2	221-1	0.000E+00	0.000E+00	1.219E+00	0.000E+00	0.000E+00	0.000E+00
STORY2	222-1	0.000E+00	0.000E+00	7.453E-01	0.000E+00	0.000E+00	0.000E+00
STORY2	223-1	0.000E+00	0.000E+00	1.947E-01	0.000E+00	0.000E+00	0.000E+00
STORY2	224-1	0.000E+00	0.000E+00	3.689E-01	0.000E+00	0.000E+00	0.000E+00
STORY2	225-1	0.000E+00	0.000E+00	9.007E-01	0.000E+00	0.000E+00	0.000E+00
STORY2	226-1	0.000E+00	0.000E+00	1.049E+00	0.000E+00	0.000E+00	0.000E+00
STORY2	227-1	0.000E+00	0.000E+00	5.375E-01	0.000E+00	0.000E+00	0.000E+00
STORY2	228-1	0.000E+00	0.000E+00	1.057E+00	0.000E+00	0.000E+00	0.000E+00
STORY2	229-1	0.000E+00	0.000E+00	3.216E-01	0.000E+00	0.000E+00	0.000E+00
STORY2	230-1	0.000E+00	0.000E+00	7.445E-01	0.000E+00	0.000E+00	0.000E+00
STORY2	231-1	0.000E+00	0.000E+00	8.598E-01	0.000E+00	0.000E+00	0.000E+00
STORY2	232-1	0.000E+00	0.000E+00	8.739E-01	0.000E+00	0.000E+00	0.000E+00
STORY2	233-1	0.000E+00	0.000E+00	2.164E-01	0.000E+00	0.000E+00	0.000E+00
STORY2	234-1	0.000E+00	0.000E+00	5.009E-01	0.000E+00	0.000E+00	0.000E+00
STORY2	235-1	0.000E+00	0.000E+00	5.785E-01	0.000E+00	0.000E+00	0.000E+00
STORY2	236-1	0.000E+00	0.000E+00	5.880E-01	0.000E+00	0.000E+00	0.000E+00
STORY2	237-1	0.000E+00	0.000E+00	3.772E-01	0.000E+00	0.000E+00	0.000E+00
STORY2	238-1	0.000E+00	0.000E+00	8.732E-01	0.000E+00	0.000E+00	0.000E+00
STORY2	239-1	0.000E+00	0.000E+00	1.008E+00	0.000E+00	0.000E+00	0.000E+00
STORY2	240-1	0.000E+00	0.000E+00	1.025E+00	0.000E+00	0.000E+00	0.000E+00
STORY2	241-1	0.000E+00	0.000E+00	4.327E+00	0.000E+00	0.000E+00	0.000E+00
STORY2	242-1	0.000E+00	0.000E+00	1.103E+00	0.000E+00	0.000E+00	0.000E+00
STORY2	243-1	0.000E+00	0.000E+00	1.274E+00	0.000E+00	0.000E+00	0.000E+00
STORY2	244-1	0.000E+00	0.000E+00	1.295E+00	0.000E+00	0.000E+00	0.000E+00
STORY2	245-1	0.000E+00	0.000E+00	3.831E-01	0.000E+00	0.000E+00	0.000E+00
STORY2	246-1	0.000E+00	0.000E+00	8.869E-01	0.000E+00	0.000E+00	0.000E+00
STORY2	247-1	0.000E+00	0.000E+00	1.024E+00	0.000E+00	0.000E+00	0.000E+00
STORY2	248-1	0.000E+00	0.000E+00	1.041E+00	0.000E+00	0.000E+00	0.000E+00
STORY2	249-1	0.000E+00	0.000E+00	4.863E-01	0.000E+00	0.000E+00	0.000E+00
STORY2	250-1	0.000E+00	0.000E+00	1.126E+00	0.000E+00	0.000E+00	0.000E+00
STORY2	251-1	0.000E+00	0.000E+00	1.300E+00	0.000E+00	0.000E+00	0.000E+00
STORY2	252-1	0.000E+00	0.000E+00	1.322E+00	0.000E+00	0.000E+00	0.000E+00
STORY2	253-1	0.000E+00	0.000E+00	4.539E-01	0.000E+00	0.000E+00	0.000E+00
STORY2	254-1	0.000E+00	0.000E+00	1.051E+00	0.000E+00	0.000E+00	0.000E+00
STORY2	255-1	0.000E+00	0.000E+00	1.214E+00	0.000E+00	0.000E+00	0.000E+00
STORY2	256-1	0.000E+00	0.000E+00	1.234E+00	0.000E+00	0.000E+00	0.000E+00
STORY2	257-1	0.000E+00	0.000E+00	3.242E-01	0.000E+00	0.000E+00	0.000E+00
STORY2	258-1	0.000E+00	0.000E+00	7.506E-01	0.000E+00	0.000E+00	0.000E+00
STORY2	259-1	0.000E+00	0.000E+00	8.669E-01	0.000E+00	0.000E+00	0.000E+00
STORY2	260-1	0.000E+00	0.000E+00	8.811E-01	0.000E+00	0.000E+00	0.000E+00
STORY2	261-1	0.000E+00	0.000E+00	8.811E-01	0.000E+00	0.000E+00	0.000E+00
STORY2	262-1	0.000E+00	0.000E+00	8.669E-01	0.000E+00	0.000E+00	0.000E+00
STORY2	263-1	0.000E+00	0.000E+00	7.506E-01	0.000E+00	0.000E+00	0.000E+00
STORY2	264-1	0.000E+00	0.000E+00	3.242E-01	0.000E+00	0.000E+00	0.000E+00
STORY2	313-1	0.000E+00	0.000E+00	5.328E-01	0.000E+00	0.000E+00	0.000E+00
STORY2	314-1	0.000E+00	0.000E+00	3.903E-01	0.000E+00	0.000E+00	0.000E+00
STORY2	315-1	0.000E+00	0.000E+00	3.137E-01	0.000E+00	0.000E+00	0.000E+00
STORY2	316-1	0.000E+00	0.000E+00	3.815E-01	0.000E+00	0.000E+00	0.000E+00
STORY2	188-7	0.000E+00	0.000E+00	2.231E-01	0.000E+00	0.000E+00	0.000E+00

A S S E M B L E D P O I N T M A S S E S

STORY	POINT	UX	UY	UZ	RX	RY	RZ
STORY2	395-1	4.083E+01	4.083E+01	0.000E+00	0.000E+00	0.000E+00	3.795E+02
STORY2	396-1	5.878E+01	5.878E+01	0.000E+00	0.000E+00	0.000E+00	9.257E+02
STORY1	1-1	1.108E+00	1.108E+00	1.108E+00	0.000E+00	0.000E+00	0.000E+00
STORY1	1-2	1.203E+00	1.203E+00	1.203E+00	0.000E+00	0.000E+00	0.000E+00
STORY1	2-1	2.889E-01	2.889E-01	2.889E-01	0.000E+00	0.000E+00	0.000E+00
STORY1	2-2	1.628E-01	1.628E-01	1.628E-01	0.000E+00	0.000E+00	0.000E+00
STORY1	1-3	2.626E-01	2.626E-01	2.626E-01	0.000E+00	0.000E+00	0.000E+00
STORY1	2-3	2.626E-01	2.626E-01	2.626E-01	0.000E+00	0.000E+00	0.000E+00
STORY1	3-1	1.364E+00	1.364E+00	1.364E+00	0.000E+00	0.000E+00	0.000E+00
STORY1	4-1	1.271E+00	1.271E+00	1.271E+00	0.000E+00	0.000E+00	0.000E+00
STORY1	4-2	1.441E+00	1.441E+00	1.441E+00	0.000E+00	0.000E+00	0.000E+00
STORY1	3-2	1.902E+00	1.902E+00	1.902E+00	0.000E+00	0.000E+00	0.000E+00
STORY1	4-3	5.016E-01	5.016E-01	5.016E-01	0.000E+00	0.000E+00	0.000E+00
STORY1	3-3	1.817E+00	1.817E+00	1.817E+00	0.000E+00	0.000E+00	0.000E+00
STORY1	5-1	1.409E+00	1.409E+00	1.409E+00	0.000E+00	0.000E+00	0.000E+00
STORY1	5-2	1.231E+00	1.231E+00	1.231E+00	0.000E+00	0.000E+00	0.000E+00
STORY1	6-1	1.404E+00	1.404E+00	1.404E+00	0.000E+00	0.000E+00	0.000E+00
STORY1	6-2	1.226E+00	1.226E+00	1.226E+00	0.000E+00	0.000E+00	0.000E+00
STORY1	7-1	1.414E+00	1.414E+00	1.414E+00	0.000E+00	0.000E+00	0.000E+00
STORY1	7-2	1.231E+00	1.231E+00	1.231E+00	0.000E+00	0.000E+00	0.000E+00
STORY1	8-1	1.409E+00	1.409E+00	1.409E+00	0.000E+00	0.000E+00	0.000E+00
STORY1	8-2	1.226E+00	1.226E+00	1.226E+00	0.000E+00	0.000E+00	0.000E+00
STORY1	9-1	1.400E+00	1.400E+00	1.400E+00	0.000E+00	0.000E+00	0.000E+00
STORY1	9-2	1.221E+00	1.221E+00	1.221E+00	0.000E+00	0.000E+00	0.000E+00
STORY1	10-1	1.395E+00	1.395E+00	1.395E+00	0.000E+00	0.000E+00	0.000E+00
STORY1	10-2	1.216E+00	1.216E+00	1.216E+00	0.000E+00	0.000E+00	0.000E+00
STORY1	11-1	1.413E+00	1.413E+00	1.413E+00	0.000E+00	0.000E+00	0.000E+00
STORY1	11-2	1.226E+00	1.226E+00	1.226E+00	0.000E+00	0.000E+00	0.000E+00
STORY1	12-1	1.413E+00	1.413E+00	1.413E+00	0.000E+00	0.000E+00	0.000E+00
STORY1	12-2	1.226E+00	1.226E+00	1.226E+00	0.000E+00	0.000E+00	0.000E+00
STORY1	13-1	1.413E+00	1.413E+00	1.413E+00	0.000E+00	0.000E+00	0.000E+00
STORY1	13-2	1.226E+00	1.226E+00	1.226E+00	0.000E+00	0.000E+00	0.000E+00
STORY1	14-1	1.413E+00	1.413E+00	1.413E+00	0.000E+00	0.000E+00	0.000E+00
STORY1	14-2	1.226E+00	1.226E+00	1.226E+00	0.000E+00	0.000E+00	0.000E+00
STORY1	6-5	4.366E-01	4.366E-01	4.366E-01	0.000E+00	0.000E+00	0.000E+00
STORY1	5-5	4.366E-01	4.366E-01	4.366E-01	0.000E+00	0.000E+00	0.000E+00
STORY1	8-5	4.448E-01	4.448E-01	4.448E-01	0.000E+00	0.000E+00	0.000E+00
STORY1	7-5	4.448E-01	4.448E-01	4.448E-01	0.000E+00	0.000E+00	0.000E+00
STORY1	10-5	4.366E-01	4.366E-01	4.366E-01	0.000E+00	0.000E+00	0.000E+00
STORY1	9-5	4.366E-01	4.366E-01	4.366E-01	0.000E+00	0.000E+00	0.000E+00
STORY1	12-5	4.531E-01	4.531E-01	4.531E-01	0.000E+00	0.000E+00	0.000E+00
STORY1	11-5	4.531E-01	4.531E-01	4.531E-01	0.000E+00	0.000E+00	0.000E+00
STORY1	14-5	4.531E-01	4.531E-01	4.531E-01	0.000E+00	0.000E+00	0.000E+00
STORY1	13-5	4.531E-01	4.531E-01	4.531E-01	0.000E+00	0.000E+00	0.000E+00
STORY1	15-1	1.129E+00	1.129E+00	1.129E+00	0.000E+00	0.000E+00	0.000E+00
STORY1	15-2	1.259E+00	1.259E+00	1.259E+00	0.000E+00	0.000E+00	0.000E+00
STORY1	16-1	1.665E+00	1.665E+00	1.665E+00	0.000E+00	0.000E+00	0.000E+00
STORY1	16-2	9.385E-01	9.385E-01	9.385E-01	0.000E+00	0.000E+00	0.000E+00
STORY1	15-3	3.343E-01	3.343E-01	3.343E-01	0.000E+00	0.000E+00	0.000E+00
STORY1	16-3	1.514E+00	1.514E+00	1.514E+00	0.000E+00	0.000E+00	0.000E+00
STORY1	17-1	1.512E+00	1.512E+00	1.512E+00	0.000E+00	0.000E+00	0.000E+00
STORY1	17-2	2.683E+00	2.683E+00	2.683E+00	0.000E+00	0.000E+00	0.000E+00
STORY1	18-1	2.233E+00	2.233E+00	2.233E+00	0.000E+00	0.000E+00	0.000E+00
STORY1	18-2	1.678E+00	1.678E+00	1.678E+00	0.000E+00	0.000E+00	0.000E+00
STORY1	17-3	2.439E+00	2.439E+00	2.439E+00	0.000E+00	0.000E+00	0.000E+00
STORY1	18-3	1.220E+00	1.220E+00	1.220E+00	0.000E+00	0.000E+00	0.000E+00
STORY1	19-1	1.512E+00	1.512E+00	1.512E+00	0.000E+00	0.000E+00	0.000E+00
STORY1	19-2	2.683E+00	2.683E+00	2.683E+00	0.000E+00	0.000E+00	0.000E+00
STORY1	19-3	2.439E+00	2.439E+00	2.439E+00	0.000E+00	0.000E+00	0.000E+00
STORY1	20-1	1.610E+00	1.610E+00	1.610E+00	0.000E+00	0.000E+00	0.000E+00
STORY1	20-2	2.168E+00	2.168E+00	2.168E+00	0.000E+00	0.000E+00	0.000E+00
STORY1	20-3	1.220E+00	1.220E+00	1.220E+00	0.000E+00	0.000E+00	0.000E+00
STORY1	21-1	1.561E+00	1.561E+00	1.561E+00	0.000E+00	0.000E+00	0.000E+00
STORY1	21-2	2.086E+00	2.086E+00	2.086E+00	0.000E+00	0.000E+00	0.000E+00
STORY1	22-1	2.093E+00	2.093E+00	2.093E+00	0.000E+00	0.000E+00	0.000E+00
STORY1	22-2	1.568E+00	1.568E+00	1.568E+00	0.000E+00	0.000E+00	0.000E+00
STORY1	21-3	1.152E+00	1.152E+00	1.152E+00	0.000E+00	0.000E+00	0.000E+00
STORY1	22-3	1.152E+00	1.152E+00	1.152E+00	0.000E+00	0.000E+00	0.000E+00
STORY1	23-1	1.508E+00	1.508E+00	1.508E+00	0.000E+00	0.000E+00	0.000E+00
STORY1	23-2	2.676E+00	2.676E+00	2.676E+00	0.000E+00	0.000E+00	0.000E+00
STORY1	24-1	2.157E+00	2.157E+00	2.157E+00	0.000E+00	0.000E+00	0.000E+00
STORY1	24-2	1.601E+00	1.601E+00	1.601E+00	0.000E+00	0.000E+00	0.000E+00
STORY1	23-3	2.433E+00	2.433E+00	2.433E+00	0.000E+00	0.000E+00	0.000E+00
STORY1	24-3	1.216E+00	1.216E+00	1.216E+00	0.000E+00	0.000E+00	0.000E+00
STORY1	25-1	1.508E+00	1.508E+00	1.508E+00	0.000E+00	0.000E+00	0.000E+00
STORY1	25-2	2.676E+00	2.676E+00	2.676E+00	0.000E+00	0.000E+00	0.000E+00
STORY1	25-3	2.433E+00	2.433E+00	2.433E+00	0.000E+00	0.000E+00	0.000E+00
STORY1	26-1	1.598E+00	1.598E+00	1.598E+00	0.000E+00	0.000E+00	0.000E+00
STORY1	26-2	2.155E+00	2.155E+00	2.155E+00	0.000E+00	0.000E+00	0.000E+00
STORY1	26-3	1.216E+00	1.216E+00	1.216E+00	0.000E+00	0.000E+00	0.000E+00
STORY1	27-1	2.387E+00	2.387E+00	2.387E+00	0.000E+00	0.000E+00	0.000E+00
STORY1	27-2	3.501E+00	3.501E+00	3.501E+00	0.000E+00	0.000E+00	0.000E+00
STORY1	28-1	1.958E+00	1.958E+00	1.958E+00	0.000E+00	0.000E+00	0.000E+00
STORY1	28-2	1.538E+00	1.538E+00	1.538E+00	0.000E+00	0.000E+00	0.000E+00
STORY1	27-3	3.781E+00	3.781E+00	3.781E+00	0.000E+00	0.000E+00	0.000E+00
STORY1	28-3	1.119E+00	1.119E+00	1.119E+00	0.000E+00	0.000E+00	0.000E+00
STORY1	29-1	1.279E+00	1.279E+00	1.279E+00	0.000E+00	0.000E+00	0.000E+00

ASSEMBLED POINT MASSES

STORY	POINT	UX	UY	UZ	RX	RY	RZ
STORY1	29-2	2.269E+00	2.269E+00	2.269E+00	0.000E+00	0.000E+00	0.000E+00
STORY1	30-1	1.989E+00	1.989E+00	1.989E+00	0.000E+00	0.000E+00	0.000E+00
STORY1	30-2	1.560E+00	1.560E+00	1.560E+00	0.000E+00	0.000E+00	0.000E+00
STORY1	29-3	2.063E+00	2.063E+00	2.063E+00	0.000E+00	0.000E+00	0.000E+00
STORY1	30-3	9.585E-01	9.585E-01	9.585E-01	0.000E+00	0.000E+00	0.000E+00
STORY1	31-3	1.318E+00	1.318E+00	1.318E+00	0.000E+00	0.000E+00	0.000E+00
STORY1	32-3	1.318E+00	1.318E+00	1.318E+00	0.000E+00	0.000E+00	0.000E+00
STORY1	32-4	2.384E+00	2.384E+00	2.384E+00	0.000E+00	0.000E+00	0.000E+00
STORY1	31-4	2.384E+00	2.384E+00	2.384E+00	0.000E+00	0.000E+00	0.000E+00
STORY1	33-3	1.318E+00	1.318E+00	1.318E+00	0.000E+00	0.000E+00	0.000E+00
STORY1	33-4	2.384E+00	2.384E+00	2.384E+00	0.000E+00	0.000E+00	0.000E+00
STORY1	34-3	2.384E+00	2.384E+00	2.384E+00	0.000E+00	0.000E+00	0.000E+00
STORY1	34-4	1.318E+00	1.318E+00	1.318E+00	0.000E+00	0.000E+00	0.000E+00
STORY1	35-3	1.318E+00	1.318E+00	1.318E+00	0.000E+00	0.000E+00	0.000E+00
STORY1	35-4	2.384E+00	2.384E+00	2.384E+00	0.000E+00	0.000E+00	0.000E+00
STORY1	36-3	2.384E+00	2.384E+00	2.384E+00	0.000E+00	0.000E+00	0.000E+00
STORY1	36-4	1.318E+00	1.318E+00	1.318E+00	0.000E+00	0.000E+00	0.000E+00
STORY1	37-3	1.318E+00	1.318E+00	1.318E+00	0.000E+00	0.000E+00	0.000E+00
STORY1	37-4	2.384E+00	2.384E+00	2.384E+00	0.000E+00	0.000E+00	0.000E+00
STORY1	38-3	2.384E+00	2.384E+00	2.384E+00	0.000E+00	0.000E+00	0.000E+00
STORY1	38-4	1.318E+00	1.318E+00	1.318E+00	0.000E+00	0.000E+00	0.000E+00
STORY1	39-3	1.318E+00	1.318E+00	1.318E+00	0.000E+00	0.000E+00	0.000E+00
STORY1	39-4	2.384E+00	2.384E+00	2.384E+00	0.000E+00	0.000E+00	0.000E+00
STORY1	40-3	2.384E+00	2.384E+00	2.384E+00	0.000E+00	0.000E+00	0.000E+00
STORY1	40-4	1.318E+00	1.318E+00	1.318E+00	0.000E+00	0.000E+00	0.000E+00
STORY1	41-3	8.241E-01	8.241E-01	8.241E-01	0.000E+00	0.000E+00	0.000E+00
STORY1	41-4	1.775E+00	1.775E+00	1.775E+00	0.000E+00	0.000E+00	0.000E+00
STORY1	42-3	2.908E+00	2.908E+00	2.908E+00	0.000E+00	0.000E+00	0.000E+00
STORY1	42-4	3.140E+00	3.140E+00	3.140E+00	0.000E+00	0.000E+00	0.000E+00
STORY1	31-5	1.783E+00	1.783E+00	1.783E+00	0.000E+00	0.000E+00	0.000E+00
STORY1	32-5	1.783E+00	1.783E+00	1.783E+00	0.000E+00	0.000E+00	0.000E+00
STORY1	33-5	1.783E+00	1.783E+00	1.783E+00	0.000E+00	0.000E+00	0.000E+00
STORY1	34-5	1.783E+00	1.783E+00	1.783E+00	0.000E+00	0.000E+00	0.000E+00
STORY1	35-5	1.783E+00	1.783E+00	1.783E+00	0.000E+00	0.000E+00	0.000E+00
STORY1	36-5	1.783E+00	1.783E+00	1.783E+00	0.000E+00	0.000E+00	0.000E+00
STORY1	37-5	1.783E+00	1.783E+00	1.783E+00	0.000E+00	0.000E+00	0.000E+00
STORY1	38-5	1.783E+00	1.783E+00	1.783E+00	0.000E+00	0.000E+00	0.000E+00
STORY1	39-5	1.783E+00	1.783E+00	1.783E+00	0.000E+00	0.000E+00	0.000E+00
STORY1	40-5	1.783E+00	1.783E+00	1.783E+00	0.000E+00	0.000E+00	0.000E+00
STORY1	41-5	1.477E+00	1.477E+00	1.477E+00	0.000E+00	0.000E+00	0.000E+00
STORY1	42-5	1.981E+00	1.981E+00	1.981E+00	0.000E+00	0.000E+00	0.000E+00
STORY1	43-1	7.313E-01	7.313E-01	7.313E-01	0.000E+00	0.000E+00	0.000E+00
STORY1	44-1	6.848E-01	6.848E-01	6.848E-01	0.000E+00	0.000E+00	0.000E+00
STORY1	49-4	2.209E+00	2.209E+00	2.209E+00	0.000E+00	0.000E+00	0.000E+00
STORY1	49-5	2.430E+00	2.430E+00	2.430E+00	0.000E+00	0.000E+00	0.000E+00
STORY1	49-6	1.370E+00	1.370E+00	1.370E+00	0.000E+00	0.000E+00	0.000E+00
STORY1	48-3	2.430E+00	2.430E+00	2.430E+00	0.000E+00	0.000E+00	0.000E+00
STORY1	48-4	1.370E+00	1.370E+00	1.370E+00	0.000E+00	0.000E+00	0.000E+00
STORY1	48-5	2.209E+00	2.209E+00	2.209E+00	0.000E+00	0.000E+00	0.000E+00
STORY1	44-4	1.215E+00	1.215E+00	1.215E+00	0.000E+00	0.000E+00	0.000E+00
STORY1	44-5	1.105E+00	1.105E+00	1.105E+00	0.000E+00	0.000E+00	0.000E+00
STORY1	46-3	1.463E+00	1.463E+00	1.463E+00	0.000E+00	0.000E+00	0.000E+00
STORY1	46-4	2.595E+00	2.595E+00	2.595E+00	0.000E+00	0.000E+00	0.000E+00
STORY1	46-5	2.359E+00	2.359E+00	2.359E+00	0.000E+00	0.000E+00	0.000E+00
STORY1	47-3	1.463E+00	1.463E+00	1.463E+00	0.000E+00	0.000E+00	0.000E+00
STORY1	47-4	2.595E+00	2.595E+00	2.595E+00	0.000E+00	0.000E+00	0.000E+00
STORY1	47-5	2.359E+00	2.359E+00	2.359E+00	0.000E+00	0.000E+00	0.000E+00
STORY1	43-4	1.297E+00	1.297E+00	1.297E+00	0.000E+00	0.000E+00	0.000E+00
STORY1	43-5	1.179E+00	1.179E+00	1.179E+00	0.000E+00	0.000E+00	0.000E+00
STORY1	55-5	2.356E+00	2.356E+00	2.356E+00	0.000E+00	0.000E+00	0.000E+00
STORY1	55-6	2.498E+00	2.498E+00	2.498E+00	0.000E+00	0.000E+00	0.000E+00
STORY1	55-7	1.461E+00	1.461E+00	1.461E+00	0.000E+00	0.000E+00	0.000E+00
STORY1	54-3	2.987E+00	2.987E+00	2.987E+00	0.000E+00	0.000E+00	0.000E+00
STORY1	54-4	1.684E+00	1.684E+00	1.684E+00	0.000E+00	0.000E+00	0.000E+00
STORY1	54-5	2.716E+00	2.716E+00	2.716E+00	0.000E+00	0.000E+00	0.000E+00
STORY1	53-3	1.691E+00	1.691E+00	1.691E+00	0.000E+00	0.000E+00	0.000E+00
STORY1	53-4	9.533E-01	9.533E-01	9.533E-01	0.000E+00	0.000E+00	0.000E+00
STORY1	53-5	1.538E+00	1.538E+00	1.538E+00	0.000E+00	0.000E+00	0.000E+00
STORY1	50-3	1.560E+00	1.560E+00	1.560E+00	0.000E+00	0.000E+00	0.000E+00
STORY1	50-4	2.667E+00	2.667E+00	2.667E+00	0.000E+00	0.000E+00	0.000E+00
STORY1	50-5	2.516E+00	2.516E+00	2.516E+00	0.000E+00	0.000E+00	0.000E+00
STORY1	51-3	1.560E+00	1.560E+00	1.560E+00	0.000E+00	0.000E+00	0.000E+00
STORY1	51-4	2.768E+00	2.768E+00	2.768E+00	0.000E+00	0.000E+00	0.000E+00
STORY1	51-5	2.516E+00	2.516E+00	2.516E+00	0.000E+00	0.000E+00	0.000E+00
STORY1	52-3	7.800E-01	7.800E-01	7.800E-01	0.000E+00	0.000E+00	0.000E+00
STORY1	52-4	1.384E+00	1.384E+00	1.384E+00	0.000E+00	0.000E+00	0.000E+00
STORY1	52-5	1.258E+00	1.258E+00	1.258E+00	0.000E+00	0.000E+00	0.000E+00
STORY1	56-1	2.019E+00	2.019E+00	2.019E+00	0.000E+00	0.000E+00	0.000E+00
STORY1	56-2	1.461E+00	1.461E+00	1.461E+00	0.000E+00	0.000E+00	0.000E+00
STORY1	57-1	1.140E+00	1.140E+00	1.140E+00	0.000E+00	0.000E+00	0.000E+00
STORY1	57-2	1.557E+00	1.557E+00	1.557E+00	0.000E+00	0.000E+00	0.000E+00
STORY1	58-1	2.336E+00	2.336E+00	2.336E+00	0.000E+00	0.000E+00	0.000E+00
STORY1	58-2	1.684E+00	1.684E+00	1.684E+00	0.000E+00	0.000E+00	0.000E+00
STORY1	59-1	2.713E+00	2.713E+00	2.713E+00	0.000E+00	0.000E+00	0.000E+00
STORY1	59-2	1.956E+00	1.956E+00	1.956E+00	0.000E+00	0.000E+00	0.000E+00
STORY1	60-1	2.251E+00	2.251E+00	2.251E+00	0.000E+00	0.000E+00	0.000E+00
STORY1	61-1	1.560E+00	1.560E+00	1.560E+00	0.000E+00	0.000E+00	0.000E+00





00035437908851CD669C51C48E7881

Ημ/νία έκδοσης πρόξης: 07/06/2022
 ΕΛΕΓΧΟΣ ΕΓΚΥΡΟΤΗΤΑΣ
<https://apps.tee.gr/adeiapublic/faces/searchDocFile>

ETABS v9.7.0 File:ANATOLIKH_PTERYGA_3000_ENISXISI Units:KN-m Οαοογίανειο 23, 2010 9:52 PAGE 22

A S S E M B L E D P O I N T M A S S E S

STORY	POINT	UX	UY	UZ	RX	RY	RZ
STORY1	61-2	2.156E+00	2.156E+00	2.156E+00	0.000E+00	0.000E+00	0.000E+00
STORY1	60-2	3.074E+00	3.074E+00	3.074E+00	0.000E+00	0.000E+00	0.000E+00
STORY1	62-1	1.560E+00	1.560E+00	1.560E+00	0.000E+00	0.000E+00	0.000E+00
STORY1	62-2	2.164E+00	2.164E+00	2.164E+00	0.000E+00	0.000E+00	0.000E+00
STORY1	63-1	1.783E+00	1.783E+00	1.783E+00	0.000E+00	0.000E+00	0.000E+00
STORY1	63-2	2.473E+00	2.473E+00	2.473E+00	0.000E+00	0.000E+00	0.000E+00
STORY1	56-3	6.205E-01	6.205E-01	6.205E-01	0.000E+00	0.000E+00	0.000E+00
STORY1	57-3	4.845E-01	4.845E-01	4.845E-01	0.000E+00	0.000E+00	0.000E+00
STORY1	58-3	7.061E-01	7.061E-01	7.061E-01	0.000E+00	0.000E+00	0.000E+00
STORY1	59-3	8.203E-01	8.203E-01	8.203E-01	0.000E+00	0.000E+00	0.000E+00
STORY1	61-3	6.626E-01	6.626E-01	6.626E-01	0.000E+00	0.000E+00	0.000E+00
STORY1	60-3	9.520E-01	9.520E-01	9.520E-01	0.000E+00	0.000E+00	0.000E+00
STORY1	62-3	6.542E-01	6.542E-01	6.542E-01	0.000E+00	0.000E+00	0.000E+00
STORY1	63-3	7.477E-01	7.477E-01	7.477E-01	0.000E+00	0.000E+00	0.000E+00
STORY1	64-1	1.931E+00	1.931E+00	1.931E+00	0.000E+00	0.000E+00	0.000E+00
STORY1	64-2	2.669E+00	2.669E+00	2.669E+00	0.000E+00	0.000E+00	0.000E+00
STORY1	64-3	8.203E-01	8.203E-01	8.203E-01	0.000E+00	0.000E+00	0.000E+00
STORY1	65-1	1.549E+00	1.549E+00	1.549E+00	0.000E+00	0.000E+00	0.000E+00
STORY1	65-2	2.149E+00	2.149E+00	2.149E+00	0.000E+00	0.000E+00	0.000E+00
STORY1	65-3	6.496E-01	6.496E-01	6.496E-01	0.000E+00	0.000E+00	0.000E+00
STORY1	57-4	6.209E-01	6.209E-01	6.209E-01	0.000E+00	0.000E+00	0.000E+00
STORY1	60-4	7.846E-01	7.846E-01	7.846E-01	0.000E+00	0.000E+00	0.000E+00
STORY1	76-13	9.020E-01	9.020E-01	9.020E-01	0.000E+00	0.000E+00	0.000E+00
STORY1	79-13	5.571E-01	5.571E-01	5.571E-01	0.000E+00	0.000E+00	0.000E+00
STORY1	71-11	3.995E-01	3.995E-01	3.995E-01	0.000E+00	0.000E+00	0.000E+00
STORY1	70-11	6.129E-01	6.129E-01	6.129E-01	0.000E+00	0.000E+00	0.000E+00
STORY1	68-11	5.516E-01	5.516E-01	5.516E-01	0.000E+00	0.000E+00	0.000E+00
STORY1	67-11	6.728E-01	6.728E-01	6.728E-01	0.000E+00	0.000E+00	0.000E+00
STORY1	81-12	7.416E-01	7.416E-01	7.416E-01	0.000E+00	0.000E+00	0.000E+00
STORY1	82-11	2.646E-01	2.646E-01	2.646E-01	0.000E+00	0.000E+00	0.000E+00
STORY1	69-11	6.240E-01	6.240E-01	6.240E-01	0.000E+00	0.000E+00	0.000E+00
STORY1	72-11	8.502E-01	8.502E-01	8.502E-01	0.000E+00	0.000E+00	0.000E+00
STORY1	76-14	2.910E-02	2.910E-02	2.910E-02	0.000E+00	0.000E+00	0.000E+00
STORY1	79-14	1.797E-02	1.797E-02	1.797E-02	0.000E+00	0.000E+00	0.000E+00
STORY1	71-14	1.289E-02	1.289E-02	1.289E-02	0.000E+00	0.000E+00	0.000E+00
STORY1	70-14	1.977E-02	1.977E-02	1.977E-02	0.000E+00	0.000E+00	0.000E+00
STORY1	68-14	1.779E-02	1.779E-02	1.779E-02	0.000E+00	0.000E+00	0.000E+00
STORY1	67-14	2.170E-02	2.170E-02	2.170E-02	0.000E+00	0.000E+00	0.000E+00
STORY1	81-13	2.392E-02	2.392E-02	2.392E-02	0.000E+00	0.000E+00	0.000E+00
STORY1	82-14	8.537E-03	8.537E-03	8.537E-03	0.000E+00	0.000E+00	0.000E+00
STORY1	69-14	2.013E-02	2.013E-02	2.013E-02	0.000E+00	0.000E+00	0.000E+00
STORY1	72-14	2.743E-02	2.743E-02	2.743E-02	0.000E+00	0.000E+00	0.000E+00
STORY1	78-9	1.965E+00	1.965E+00	1.965E+00	0.000E+00	0.000E+00	0.000E+00
STORY1	77-15	1.010E+00	1.010E+00	1.010E+00	0.000E+00	0.000E+00	0.000E+00
STORY1	75-7	1.299E+00	1.299E+00	1.299E+00	0.000E+00	0.000E+00	0.000E+00
STORY1	73-11	1.396E+00	1.396E+00	1.396E+00	0.000E+00	0.000E+00	0.000E+00
STORY1	66-11	9.885E-01	9.885E-01	9.885E-01	0.000E+00	0.000E+00	0.000E+00
STORY1	89-7	4.465E-01	4.465E-01	4.465E-01	0.000E+00	0.000E+00	0.000E+00
STORY1	88-7	1.045E+00	1.045E+00	1.045E+00	0.000E+00	0.000E+00	0.000E+00
STORY1	87-7	1.364E+00	1.364E+00	1.364E+00	0.000E+00	0.000E+00	0.000E+00
STORY1	97-4	1.254E+00	1.254E+00	1.254E+00	0.000E+00	0.000E+00	0.000E+00
STORY1	95-6	3.830E-01	3.830E-01	3.830E-01	0.000E+00	0.000E+00	0.000E+00
STORY1	96-6	1.010E+00	1.010E+00	1.010E+00	0.000E+00	0.000E+00	0.000E+00
STORY1	93-3	1.313E+00	1.313E+00	1.313E+00	0.000E+00	0.000E+00	0.000E+00
STORY1	98-1	2.301E+00	2.301E+00	2.301E+00	0.000E+00	0.000E+00	0.000E+00
STORY1	98-2	1.637E+00	1.637E+00	1.637E+00	0.000E+00	0.000E+00	0.000E+00
STORY1	98-3	3.054E-01	3.054E-01	3.054E-01	0.000E+00	0.000E+00	0.000E+00
STORY1	77-16	3.258E-02	3.258E-02	3.258E-02	0.000E+00	0.000E+00	0.000E+00
STORY1	78-16	6.340E-02	6.340E-02	6.340E-02	0.000E+00	0.000E+00	0.000E+00
STORY1	75-10	4.191E-02	4.191E-02	4.191E-02	0.000E+00	0.000E+00	0.000E+00
STORY1	73-14	4.504E-02	4.504E-02	4.504E-02	0.000E+00	0.000E+00	0.000E+00
STORY1	66-14	3.189E-02	3.189E-02	3.189E-02	0.000E+00	0.000E+00	0.000E+00
STORY1	89-10	1.440E-02	1.440E-02	1.440E-02	0.000E+00	0.000E+00	0.000E+00
STORY1	88-10	3.370E-02	3.370E-02	3.370E-02	0.000E+00	0.000E+00	0.000E+00
STORY1	87-10	4.401E-02	4.401E-02	4.401E-02	0.000E+00	0.000E+00	0.000E+00
STORY1	97-5	4.044E-02	4.044E-02	4.044E-02	0.000E+00	0.000E+00	0.000E+00
STORY1	95-7	1.236E-02	1.236E-02	1.236E-02	0.000E+00	0.000E+00	0.000E+00
STORY1	96-7	3.258E-02	3.258E-02	3.258E-02	0.000E+00	0.000E+00	0.000E+00
STORY1	99-2	2.121E+00	2.121E+00	2.121E+00	0.000E+00	0.000E+00	0.000E+00
STORY1	100-1	4.334E-01	4.334E-01	4.334E-01	0.000E+00	0.000E+00	0.000E+00
STORY1	110-6	1.185E+00	1.185E+00	1.185E+00	0.000E+00	0.000E+00	0.000E+00
STORY1	109-6	1.614E+00	1.614E+00	1.614E+00	0.000E+00	0.000E+00	0.000E+00
STORY1	108-4	1.452E+00	1.452E+00	1.452E+00	0.000E+00	0.000E+00	0.000E+00
STORY1	107-4	1.443E+00	1.443E+00	1.443E+00	0.000E+00	0.000E+00	0.000E+00
STORY1	106-4	1.446E+00	1.446E+00	1.446E+00	0.000E+00	0.000E+00	0.000E+00
STORY1	105-4	1.455E+00	1.455E+00	1.455E+00	0.000E+00	0.000E+00	0.000E+00
STORY1	104-4	1.432E+00	1.432E+00	1.432E+00	0.000E+00	0.000E+00	0.000E+00
STORY1	103-4	1.439E+00	1.439E+00	1.439E+00	0.000E+00	0.000E+00	0.000E+00
STORY1	102-4	1.205E+00	1.205E+00	1.205E+00	0.000E+00	0.000E+00	0.000E+00
STORY1	101-6	7.034E-01	7.034E-01	7.034E-01	0.000E+00	0.000E+00	0.000E+00
STORY1	99-8	1.962E+00	1.962E+00	1.962E+00	0.000E+00	0.000E+00	0.000E+00
STORY1	99-9	1.418E+00	1.418E+00	1.418E+00	0.000E+00	0.000E+00	0.000E+00
STORY1	100-7	1.655E-02	1.655E-02	1.655E-02	0.000E+00	0.000E+00	0.000E+00
STORY1	110-7	3.823E-02	3.823E-02	3.823E-02	0.000E+00	0.000E+00	0.000E+00
STORY1	109-7	5.207E-02	5.207E-02	5.207E-02	0.000E+00	0.000E+00	0.000E+00
STORY1	108-7	4.683E-02	4.683E-02	4.683E-02	0.000E+00	0.000E+00	0.000E+00
STORY1	107-7	4.656E-02	4.656E-02	4.656E-02	0.000E+00	0.000E+00	0.000E+00

ASSEMBLED POINT MASSES

STORY	POINT	UX	UY	UZ	RX	RY	RZ
BASE	6	3.954E-02	3.954E-02	3.954E-02	0.000E+00	0.000E+00	0.000E+00
BASE	7	3.970E-02	3.970E-02	3.970E-02	0.000E+00	0.000E+00	0.000E+00
BASE	8	3.954E-02	3.954E-02	3.954E-02	0.000E+00	0.000E+00	0.000E+00
BASE	9	3.937E-02	3.937E-02	3.937E-02	0.000E+00	0.000E+00	0.000E+00
BASE	10	3.921E-02	3.921E-02	3.921E-02	0.000E+00	0.000E+00	0.000E+00
BASE	11	3.954E-02	3.954E-02	3.954E-02	0.000E+00	0.000E+00	0.000E+00
BASE	12	3.954E-02	3.954E-02	3.954E-02	0.000E+00	0.000E+00	0.000E+00
BASE	13	3.954E-02	3.954E-02	3.954E-02	0.000E+00	0.000E+00	0.000E+00
BASE	14	3.954E-02	3.954E-02	3.954E-02	0.000E+00	0.000E+00	0.000E+00
BASE	15	3.641E-02	3.641E-02	3.641E-02	0.000E+00	0.000E+00	0.000E+00
BASE	16	3.027E-02	3.027E-02	3.027E-02	0.000E+00	0.000E+00	0.000E+00
BASE	17	4.879E-02	4.879E-02	4.879E-02	0.000E+00	0.000E+00	0.000E+00
BASE	18	5.412E-02	5.412E-02	5.412E-02	0.000E+00	0.000E+00	0.000E+00
BASE	19	4.879E-02	4.879E-02	4.879E-02	0.000E+00	0.000E+00	0.000E+00
BASE	20	5.193E-02	5.193E-02	5.193E-02	0.000E+00	0.000E+00	0.000E+00
BASE	21	5.035E-02	5.035E-02	5.035E-02	0.000E+00	0.000E+00	0.000E+00
BASE	22	5.058E-02	5.058E-02	5.058E-02	0.000E+00	0.000E+00	0.000E+00
BASE	23	4.866E-02	4.866E-02	4.866E-02	0.000E+00	0.000E+00	0.000E+00
BASE	24	5.164E-02	5.164E-02	5.164E-02	0.000E+00	0.000E+00	0.000E+00
BASE	25	4.866E-02	4.866E-02	4.866E-02	0.000E+00	0.000E+00	0.000E+00
BASE	26	5.155E-02	5.155E-02	5.155E-02	0.000E+00	0.000E+00	0.000E+00
BASE	27	7.700E-02	7.700E-02	7.700E-02	0.000E+00	0.000E+00	0.000E+00
BASE	28	4.960E-02	4.960E-02	4.960E-02	0.000E+00	0.000E+00	0.000E+00
BASE	29	4.126E-02	4.126E-02	4.126E-02	0.000E+00	0.000E+00	0.000E+00
BASE	30	5.032E-02	5.032E-02	5.032E-02	0.000E+00	0.000E+00	0.000E+00
BASE	31	5.751E-02	5.751E-02	5.751E-02	0.000E+00	0.000E+00	0.000E+00
BASE	32	5.751E-02	5.751E-02	5.751E-02	0.000E+00	0.000E+00	0.000E+00
BASE	33	5.751E-02	5.751E-02	5.751E-02	0.000E+00	0.000E+00	0.000E+00
BASE	34	5.751E-02	5.751E-02	5.751E-02	0.000E+00	0.000E+00	0.000E+00
BASE	35	5.751E-02	5.751E-02	5.751E-02	0.000E+00	0.000E+00	0.000E+00
BASE	36	5.751E-02	5.751E-02	5.751E-02	0.000E+00	0.000E+00	0.000E+00
BASE	37	5.751E-02	5.751E-02	5.751E-02	0.000E+00	0.000E+00	0.000E+00
BASE	38	5.751E-02	5.751E-02	5.751E-02	0.000E+00	0.000E+00	0.000E+00
BASE	39	5.751E-02	5.751E-02	5.751E-02	0.000E+00	0.000E+00	0.000E+00
BASE	40	5.751E-02	5.751E-02	5.751E-02	0.000E+00	0.000E+00	0.000E+00
BASE	41	4.763E-02	4.763E-02	4.763E-02	0.000E+00	0.000E+00	0.000E+00
BASE	42	6.390E-02	6.390E-02	6.390E-02	0.000E+00	0.000E+00	0.000E+00
BASE	43	2.359E-02	2.359E-02	2.359E-02	0.000E+00	0.000E+00	0.000E+00
BASE	44	2.209E-02	2.209E-02	2.209E-02	0.000E+00	0.000E+00	0.000E+00
BASE	46	4.718E-02	4.718E-02	4.718E-02	0.000E+00	0.000E+00	0.000E+00
BASE	47	4.718E-02	4.718E-02	4.718E-02	0.000E+00	0.000E+00	0.000E+00
BASE	48	4.418E-02	4.418E-02	4.418E-02	0.000E+00	0.000E+00	0.000E+00
BASE	49	4.418E-02	4.418E-02	4.418E-02	0.000E+00	0.000E+00	0.000E+00
BASE	50	5.032E-02	5.032E-02	5.032E-02	0.000E+00	0.000E+00	0.000E+00
BASE	51	5.032E-02	5.032E-02	5.032E-02	0.000E+00	0.000E+00	0.000E+00
BASE	52	2.516E-02	2.516E-02	2.516E-02	0.000E+00	0.000E+00	0.000E+00
BASE	53	3.075E-02	3.075E-02	3.075E-02	0.000E+00	0.000E+00	0.000E+00
BASE	54	5.432E-02	5.432E-02	5.432E-02	0.000E+00	0.000E+00	0.000E+00
BASE	55	4.713E-02	4.713E-02	4.713E-02	0.000E+00	0.000E+00	0.000E+00
BASE	56	4.713E-02	4.713E-02	4.713E-02	0.000E+00	0.000E+00	0.000E+00
BASE	57	3.677E-02	3.677E-02	3.677E-02	0.000E+00	0.000E+00	0.000E+00
BASE	58	5.432E-02	5.432E-02	5.432E-02	0.000E+00	0.000E+00	0.000E+00
BASE	59	6.310E-02	6.310E-02	6.310E-02	0.000E+00	0.000E+00	0.000E+00
BASE	60	7.262E-02	7.262E-02	7.262E-02	0.000E+00	0.000E+00	0.000E+00
BASE	61	5.032E-02	5.032E-02	5.032E-02	0.000E+00	0.000E+00	0.000E+00
BASE	62	5.032E-02	5.032E-02	5.032E-02	0.000E+00	0.000E+00	0.000E+00
BASE	63	5.751E-02	5.751E-02	5.751E-02	0.000E+00	0.000E+00	0.000E+00
BASE	64	6.230E-02	6.230E-02	6.230E-02	0.000E+00	0.000E+00	0.000E+00
BASE	65	4.997E-02	4.997E-02	4.997E-02	0.000E+00	0.000E+00	0.000E+00
BASE	98	5.279E-02	5.279E-02	5.279E-02	0.000E+00	0.000E+00	0.000E+00
BASE	99	4.575E-02	4.575E-02	4.575E-02	0.000E+00	0.000E+00	0.000E+00
BASE	115	3.707E-02	3.707E-02	3.707E-02	0.000E+00	0.000E+00	0.000E+00
STORY8	All	0.000E+00	0.000E+00	0.000E+00	0.000E+00	0.000E+00	0.000E+00
STORY7	All	0.000E+00	0.000E+00	0.000E+00	0.000E+00	0.000E+00	0.000E+00
STORY6	All	0.000E+00	0.000E+00	0.000E+00	0.000E+00	0.000E+00	0.000E+00
STORY5	All	1.102E+02	1.102E+02	1.102E+02	0.000E+00	0.000E+00	0.000E+00
STORY4	All	2.489E+02	2.489E+02	2.489E+02	0.000E+00	0.000E+00	9.063E+02
STORY3	All	5.437E+02	5.437E+02	5.437E+02	0.000E+00	0.000E+00	0.000E+00
STORY2	All	7.361E+02	7.361E+02	7.361E+02	0.000E+00	0.000E+00	2.160E+03
STORY1	All	4.356E+02	4.356E+02	4.356E+02	0.000E+00	0.000E+00	0.000E+00
BASE	All	3.164E+00	3.164E+00	3.164E+00	0.000E+00	0.000E+00	0.000E+00
Totals	All	2.078E+03	2.078E+03	2.078E+03	0.000E+00	0.000E+00	3.066E+03

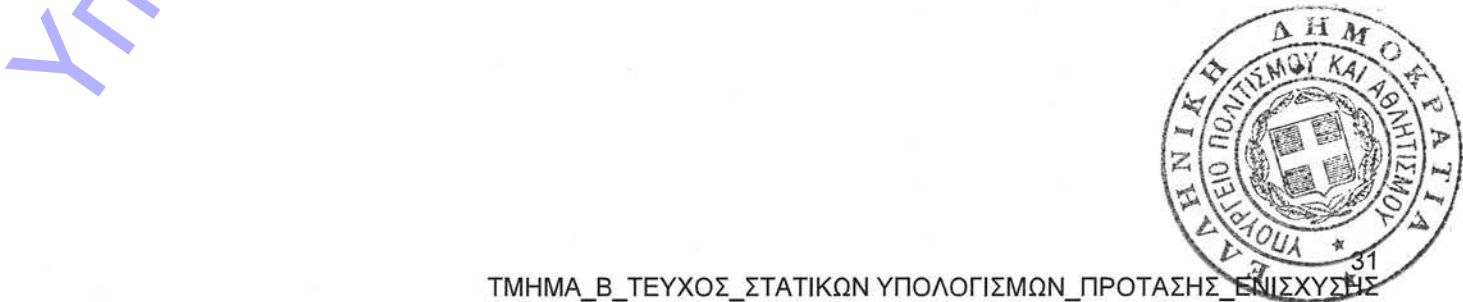

SUPPORT (RESTRAINT) DATA

STORY	POINT	/-----RESTRAINED DOF's-----/					
		UX	UY	UZ	RX	RY	RZ
STORY1	76-14	Yes	Yes				
STORY1	79-14	Yes	Yes				
STORY1	71-14	Yes	Yes				
STORY1	70-14	Yes	Yes				
STORY1	68-14	Yes	Yes				
STORY1	67-14	Yes	Yes				
STORY1	81-13	Yes	Yes				
STORY1	82-14	Yes	Yes				
STORY1	69-14	Yes	Yes				
STORY1	72-14	Yes	Yes				
STORY1	77-16	Yes	Yes				
STORY1	78-16	Yes	Yes				
STORY1	75-10	Yes	Yes				
STORY1	73-14	Yes	Yes				
STORY1	66-14	Yes	Yes				
STORY1	89-10	Yes	Yes				
STORY1	88-10	Yes	Yes				
STORY1	87-10	Yes	Yes				
STORY1	97-5	Yes	Yes				
STORY1	95-7	Yes	Yes				
STORY1	96-7	Yes	Yes				
STORY1	100-7	Yes	Yes				
STORY1	110-7	Yes	Yes				
STORY1	109-7	Yes	Yes				
STORY1	108-7	Yes	Yes				
STORY1	107-7	Yes	Yes				
STORY1	106-7	Yes	Yes				
STORY1	105-7	Yes	Yes				
STORY1	104-7	Yes	Yes				
STORY1	103-7	Yes	Yes				
STORY1	102-7	Yes	Yes				
STORY1	101-7	Yes	Yes				
STORY1	111-8	Yes	Yes				
STORY1	127-8	Yes	Yes				
STORY1	112-8	Yes	Yes				
STORY1	113-7	Yes	Yes				
STORY1	128-7	Yes	Yes				
STORY1	129-7	Yes	Yes				
STORY1	130-8	Yes	Yes				
STORY1	114-8	Yes	Yes				
STORY1	126-7	Yes	Yes				
STORY1	125-7	Yes	Yes				
STORY1	124-7	Yes	Yes				
STORY1	123-7	Yes	Yes				
STORY1	122-7	Yes	Yes				
STORY1	121-7	Yes	Yes				
STORY1	120-7	Yes	Yes				
STORY1	119-7	Yes	Yes				
STORY1	118-7	Yes	Yes				
STORY1	117-7	Yes	Yes				
STORY1	116-7	Yes	Yes				
STORY1	131-7	Yes	Yes				
STORY1	132-8	Yes	Yes				
STORY1	133-8	Yes	Yes				
STORY1	134-8	Yes	Yes				
STORY1	135-8	Yes	Yes				
STORY1	136-8	Yes	Yes				
STORY1	137-8	Yes	Yes				
STORY1	138-8	Yes	Yes				
STORY1	139-8	Yes	Yes				
STORY1	140-8	Yes	Yes				
STORY1	141-8	Yes	Yes				
STORY1	142-5	Yes	Yes				
STORY1	143-5	Yes	Yes				
STORY1	145-4	Yes	Yes				
STORY1	146-5	Yes	Yes				
STORY1	147-5	Yes	Yes				
STORY1	148-5	Yes	Yes				
STORY1	149-5	Yes	Yes				
STORY1	150-5	Yes	Yes				
STORY1	151-4	Yes	Yes				
STORY1	152-5	Yes	Yes				
STORY1	153-5	Yes	Yes				
STORY1	156-7	Yes	Yes				
STORY1	157-7	Yes	Yes				
STORY1	158-7	Yes	Yes				
STORY1	159-7	Yes	Yes				
STORY1	160-7	Yes	Yes				
STORY1	161-7	Yes	Yes				
STORY1	162-7	Yes	Yes				
STORY1	163-4	Yes	Yes				
STORY1	164-3	Yes	Yes				
STORY1	166-4	Yes	Yes				
STORY1	168-4	Yes	Yes				
STORY1	173-14	Yes	Yes				
STORY1	174-14	Yes	Yes				

Υπολογισμός Περιβάλλοντος & Ενέργειας

S U P P O R T (R E S T R A I N T) D A T A

STORY	POINT	/-----RESTRAINED DOF's-----/					
		UX	UY	UZ	RX	RY	RZ
STORY1	169-14	Yes	Yes				
STORY1	170-12	Yes	Yes				
STORY1	83-13	Yes	Yes				
STORY1	171-12	Yes	Yes				
STORY1	172-12	Yes	Yes				
STORY1	176-5	Yes	Yes				
STORY1	177-5	Yes	Yes				
STORY1	178-5	Yes	Yes				
STORY1	179-5	Yes	Yes				
STORY1	180-5	Yes	Yes				
STORY1	182-5	Yes	Yes				
STORY1	181-5	Yes	Yes				
STORY1	183-5	Yes	Yes				
STORY1	186-5	Yes	Yes				
STORY1	187-5	Yes	Yes				
STORY1	190-5	Yes	Yes				
STORY1	192-5	Yes	Yes				
STORY1	191-5	Yes	Yes				
STORY1	193-5	Yes	Yes				
STORY1	195-5	Yes	Yes				
STORY1	194-5	Yes	Yes				
STORY1	198-5	Yes	Yes				
STORY1	199-5	Yes	Yes				
STORY1	200-5	Yes	Yes				
STORY1	201-5	Yes	Yes				
STORY1	241-2	Yes	Yes				
BASE	1	Yes	Yes				
BASE	2	Yes	Yes				
BASE	3	Yes	Yes				
BASE	4	Yes	Yes				
BASE	5	Yes	Yes				
BASE	6	Yes	Yes				
BASE	7	Yes	Yes				
BASE	8	Yes	Yes				
BASE	9	Yes	Yes				
BASE	10	Yes	Yes				
BASE	11	Yes	Yes				
BASE	12	Yes	Yes				
BASE	13	Yes	Yes				
BASE	14	Yes	Yes				
BASE	15	Yes	Yes				
BASE	16	Yes	Yes				
BASE	17	Yes	Yes				
BASE	18	Yes	Yes				
BASE	19	Yes	Yes				
BASE	20	Yes	Yes				
BASE	21	Yes	Yes				
BASE	22	Yes	Yes				
BASE	23	Yes	Yes				
BASE	24	Yes	Yes				
BASE	25	Yes	Yes				
BASE	26	Yes	Yes				
BASE	27	Yes	Yes				
BASE	28	Yes	Yes				
BASE	29	Yes	Yes				
BASE	30	Yes	Yes				
BASE	31	Yes	Yes				
BASE	32	Yes	Yes				
BASE	33	Yes	Yes				
BASE	34	Yes	Yes				
BASE	35	Yes	Yes				
BASE	36	Yes	Yes				
BASE	37	Yes	Yes				
BASE	38	Yes	Yes				
BASE	39	Yes	Yes				
BASE	40	Yes	Yes				
BASE	41	Yes	Yes				
BASE	42	Yes	Yes				
BASE	43	Yes	Yes				
BASE	44	Yes	Yes				
BASE	46	Yes	Yes				
BASE	47	Yes	Yes				
BASE	48	Yes	Yes				
BASE	49	Yes	Yes				
BASE	50	Yes	Yes				
BASE	51	Yes	Yes				
BASE	52	Yes	Yes				
BASE	53	Yes	Yes				
BASE	54	Yes	Yes				
BASE	55	Yes	Yes				
BASE	56	Yes	Yes	Yes			
BASE	57	Yes	Yes				
BASE	58	Yes	Yes				
BASE	59	Yes	Yes				
BASE	60	Yes	Yes				
BASE	61	Yes	Yes				

Υποέργο Περιβάλλοντος & Ενέργειας



S U P P O R T (R E S T R A I N T) D A T A

STORY	POINT	/-----RESTRAINED DOF's-----/						
		UX	UY	UZ	RX	RY	RZ	
BASE	62	Yes	Yes					
BASE	63	Yes	Yes					
BASE	64	Yes	Yes					
BASE	65	Yes	Yes					
BASE	98	Yes	Yes					
BASE	99	Yes	Yes					
BASE	115	Yes	Yes					

Υπουργείο Περιβάλλοντος & Ενέργειας

ΕΓΚΥΡΟ ΑΝΤΙΓΡΑΦΟ	Α/Α Πράξης: 423334
 0003543A7F90B851CD669C51C48E7881	Ημ/νία έκδοσης πράξης: 07/06/2022 ΕΛΕΓΧΟΣ ΕΓΚΥΡΟΤΗΤΑΣ https://apps.tee.gr/adeiapublic/faces/searchDocFile

Υπουργείο Περιβάλλοντος & Ενέργειας

ΔΙΑΤΟΜΕΣ ΚΑΙ ΥΛΙΚΑ





0003543A7F908851CD669C51C48E7881

Ημ/νία έκδοσης πράξης: 07/06/2022
 ΕΛΕΓΧΟΣ ΕΓΚΥΡΟΤΗΤΑΣ
<https://apps.tee.gr/adeiapublic/faces/searchDocFile>

ETABS v9.7.0 File:ANATOLIKH_PTERYGA_3000_ENISXISI Units:KN-m Οαδδγίανείο 23, 2010 9:52 PAGE 26

M A T E R I A L L I S T B Y E L E M E N T T Y P E

ELEMENT TYPE	MATERIAL	TOTAL MASS tons	NUMBER PIECES	NUMBER STUDS
Column	C25	2.36	2	
Beam	C12	6.46	61	0
Beam	C25	10.10	5	0
Beam	C20	91.66	18	0
Wall	C25	47.32		
Wall	AGROLITHODO	1502.27		
Wall	BRICK	134.75		
Floor	C25	28.28		
Floor	C20	22.04		

Υπουργείο Περιβάλλοντος & Ενέργειας

M A T E R I A L L I S T B Y S E C T I O N

SECTION	ELEMENT TYPE	NUMBER PIECES	TOTAL LENGTH meters	TOTAL MASS tons	NUMBER STUDS
B20X80	Beam	5	25.500	10.10	0
BSENAZ2	Beam	61	84.496	6.46	0
C50X50	Column	2	3.700	2.36	
B35X40	Beam	9	116.476	35.63	0
B70X40	Beam	9	78.495	56.03	0
WS70	Wall			239.62	
WS75	Wall			289.08	
WS85	Wall			147.76	
WS55	Wall			83.09	
WS65	Wall			362.28	
WS80	Wall			291.29	
WB75	Wall			134.75	
WS30	Wall			43.99	
C25	Wall			47.32	
WS20	Wall			7.25	
WS35	Wall			37.91	
D15	Floor			28.28	
D8	Floor			22.04	

Υπουργείο Περιβάλλοντος & Ενέργειας





0003543A7F908851CD669C51C48E7881

M A T E R I A L L I S T B Y S T O R Y

STORY	ELEMENT TYPE	MATERIAL	TOTAL WEIGHT tons	FLOOR AREA m2	UNIT WEIGHT kg/m2	NUMBER PIECES	NUMBER STUDS
STORY5	Beam	C12	0.67	0.000	7	0	
STORY5	Beam	C20	12.91	0.000	4	0	
STORY5	Wall	C25	6.88	0.000			
STORY5	Wall	AGROLITHODO	88.33	0.000			
STORY4	Wall	C25	13.98	48.265	289.6771		
STORY4	Wall	AGROLITHODO	212.24	48.265	4397.3974		
STORY4	Floor	C20	9.84	48.265	203.9432		
STORY3	Beam	C12	2.62	0.000	25	0	
STORY3	Beam	C20	78.75	0.000	14	0	
STORY3	Wall	C25	11.77	0.000			
STORY3	Wall	AGROLITHODO	351.27	0.000			
STORY3	Wall	BRICK	43.52	0.000			
STORY2	Column	C25	1.85	133.743	13.8194	1	
STORY2	Beam	C12	3.18	133.743	23.7549	29	0
STORY2	Beam	C25	10.10	133.743	75.4823	5	0
STORY2	Wall	C25	14.47	133.743	108.1722		
STORY2	Wall	AGROLITHODO	566.38	133.743	4234.8816		
STORY2	Wall	BRICK	83.34	133.743	623.1494		
STORY2	Floor	C25	28.28	133.743	211.4719		
STORY2	Floor	C20	12.19	133.743	91.1582		
STORY1	Column	C25	0.51	0.000	1		
STORY1	Wall	C25	0.22	0.000			
STORY1	Wall	AGROLITHODO	284.04	0.000			
STORY1	Wall	BRICK	7.89	0.000			
SUM	Column	C25	2.36	182.008	12.9560	2	
SUM	Beam	C12	6.46	182.008	35.5050	61	0
SUM	Beam	C25	10.10	182.008	55.4658	5	0
SUM	Beam	C20	91.66	182.008	503.6125	18	0
SUM	Wall	C25	47.32	182.008	259.9959		
SUM	Wall	AGROLITHODO	1502.27	182.008	8253.8695		
SUM	Wall	BRICK	134.75	182.008	740.3675		
SUM	Floor	C25	28.28	182.008	155.3935		
SUM	Floor	C20	22.04	182.008	121.0667		
TOTAL	All	All	1845.23	182.008	10138.2324	86	0

M A T E R I A L P R O P E R T Y D A T A

MATERIAL NAME	MATERIAL TYPE	DESIGN TYPE	MATERIAL DIR/PLANE	MODULUS OF ELASTICITY	POISSON'S RATIO	THERMAL COEFF	SHEAR MODULUS
C12	Iso	Concrete	All	26000000.000	0.2000	1.0000E-0510833333.333	
C16	Iso	Concrete	All	27500000.000	0.2000	1.0000E-0511458333.333	
C25	Iso	Concrete	All	30500000.000	0.2000	1.0000E-0512708333.333	
C20	Iso	Concrete	All	29000000.000	0.2000	1.0000E-0512083333.333	
AGROLITHODO	Iso	None	All	7300000.000	0.2500	1.0000E-05 2920000.000	
BRICK	Iso	None	All	1200000.000	0.2500	1.0000E-05 480000.000	

M A T E R I A L P R O P E R T Y M A S S A N D W E I G H T

MATERIAL NAME	MASS PER UNIT VOL	WEIGHT PER UNIT VOL
C12	2.5480E+00	2.5000E+01
C16	2.5480E+00	2.5000E+01
C25	2.5480E+00	2.5000E+01
C20	2.5480E+00	2.5000E+01
AGROLITHODO	2.3500E+00	2.3500E+01
BRICK	1.6500E+00	1.6500E+01

M A T E R I A L D E S I G N D A T A F O R C O N C R E T E M A T E R I A L S

MATERIAL NAME	LIGHTWEIGHT CONCRETE	CONCRETE FC	REBAR FY	REBAR FYS	LIGHTWT REDUC FACT
C12	No	12000.000	500000.000	500000.000	N/A
C16	No	16000.000	500000.000	500000.000	N/A
C25	No	25000.000	500000.000	500000.000	N/A
C20	No	12000.000	500000.000	500000.000	N/A

ΥΠΟΥΡΓΕΙΟ ΠΕΡΙΒΑΛΛΟΝΤΟΣ & ΕΝΕΡΓΕΙΑΣ





FRAME SECTION PROPERTY DATA

FRAME SECTION NAME	MATERIAL NAME	SECTION SHAPE NAME OR NAME IN SECTION DATABASE FILE	CONC COL	CONC BEAM
B20X80	C25	Rectangular	Yes	
BSENAZ2	C12	Rectangular	Yes	
FORTIO	AGROLITHODO	Rectangular		
C50X50	C25	Rectangular	Yes	
B35X40	C20	Rectangular		Yes
B70X40	C20	Rectangular		Yes

FRAME SECTION PROPERTY DATA

FRAME SECTION NAME	SECTION DEPTH	FLANGE WIDTH TOP	FLANGE THICK TOP	WEB THICK	FLANGE WIDTH BOT	FLANGE THICK BOT
B20X80	0.8000	0.2000	0.0000	0.0000	0.0000	0.0000
BSENAZ2	0.1000	0.3000	0.0000	0.0000	0.0000	0.0000
FORTIO	0.0100	0.0100	0.0000	0.0000	0.0000	0.0000
C50X50	0.5000	0.5000	0.0000	0.0000	0.0000	0.0000
B35X40	0.4000	0.3000	0.0000	0.0000	0.0000	0.0000
B70X40	0.4000	0.7000	0.0000	0.0000	0.0000	0.0000

FRAME SECTION PROPERTY DATA

FRAME SECTION NAME	SECTION AREA	TORSIONAL CONSTANT	MOMENTS OF INERTIA		SHEAR AREAS	
			I33	I22	A2	A3
B20X80	0.1600	0.0018	0.0085	0.0005	0.1333	0.1333
BSENAZ2	0.0300	0.0001	0.0000	0.0002	0.0250	0.0250
FORTIO	0.0001	0.0000	0.0000	0.0000	0.0001	0.0001
C50X50	0.2500	0.0088	0.0052	0.0052	0.2083	0.2083
B35X40	0.1200	0.0019	0.0016	0.0009	0.1000	0.1000
B70X40	0.2800	0.0096	0.0037	0.0114	0.2333	0.2333

FRAME SECTION PROPERTY DATA

FRAME SECTION NAME	SECTION MODULI		PLASTIC MODULI		RADIUS OF GYRATION	
	S33	S22	Z33	Z22	R33	R22
B20X80	0.0213	0.0053	0.0320	0.0080	0.2309	0.0577
BSENAZ2	0.0005	0.0015	0.0008	0.0023	0.0289	0.0866
FORTIO	0.0000	0.0000	0.0000	0.0000	0.0029	0.0029
C50X50	0.0208	0.0208	0.0313	0.0313	0.1443	0.1443
B35X40	0.0080	0.0060	0.0120	0.0090	0.1155	0.0866
B70X40	0.0187	0.0327	0.0280	0.0490	0.1155	0.2021

FRAME SECTION WEIGHTS AND MASSES

FRAME SECTION NAME	TOTAL WEIGHT	TOTAL MASS
B20X80	99.0000	10.0901
BSENAZ2	63.3723	6.4589
FORTIO	0.0000	0.0000
C50X50	23.1250	2.3569
B35X40	349.4267	35.6136
B70X40	549.4631	56.0013

CONCRETE COLUMN DATA

FRAME SECTION NAME	REINF CONFIGURATION		REINF SIZE/TYPE	NUM BARS 3DIR/2DIR	NUM BARS CIRCULAR	BAR COVER
	LONGIT	LATERAL				
B20X80	Rectangular Ties		28Ø/Check	3/3	N/A	0.0700
BSENAZ2	Rectangular Ties		28Ø/Design	3/3	N/A	0.0300
C50X50	Rectangular Ties		28Ø/Design	3/3	N/A	0.0457

CONCRETE BEAM DATA

FRAME SECTION NAME	TOP COVER	BOT COVER	TOP LEFT AREA	TOP RIGHT AREA	BOT LEFT AREA	BOT RIGHT AREA
B35X40	0.0400	0.0400	0.000	0.000	0.000	0.000
B70X40	0.0400	0.0400	0.000	0.000	0.000	0.000

ΕΓΚΥΡΟ ΑΝΤΙΓΡΑΦΟ	Α/Α Πράξης: 423334
 0003543A7F90B851CD669C51C48E7881	Ημ/νία έκδοσης πράξης: 07/06/2022 ΕΛΕΓΧΟΣ ΕΓΚΥΡΟΤΗΤΑΣ https://apps.tee.gr/adeiapublic/faces/searchDocFile

Υπουργείο Περιβάλλοντος & Ενέργειας

ΦΟΡΤΙΑ



STATIC LOAD CASES

STATIC CASE	CASE TYPE	AUTO LAT LOAD	SELF WT MULTIPLIER	NOTIONAL FACTOR	NOTIONAL DIRECTION
DEAD	DEAD	N/A	0.0000		
SELFWEIGHT	DEAD	N/A	1.0000		

Υπουργείο Περιβάλλοντος & Ενέργειας

LOADING COMBINATIONS

COMBO	COMBO TYPE	CASE	CASE TYPE	SCALE FACTOR
DGRAV	ADD	DEAD	Static	1.3500
		LIVE	Static	1.5000
		SELFWEIGHT	Static	1.3500
DL05LL	ADD	DEAD	Static	1.0000
		LIVE	Static	0.5000
		SELFWEIGHT	Static	1.0000
EX	ADD	EX	Spectra	1.0000
		EY	Spectra	0.3000
		DEAD	Static	1.0000
		LIVE	Static	0.5000
		EZ	Spectra	0.3000
		SELFWEIGHT	Static	1.0000
EY	ADD	EX	Spectra	0.3000
		EY	Spectra	1.0000
		DEAD	Static	1.0000
		LIVE	Static	0.5000
		EZ	Spectra	0.3000
		SELFWEIGHT	Static	1.0000
EZ	ADD	EX	Spectra	0.3000
		EY	Spectra	0.3000
		EZ	Spectra	1.0000
		DEAD	Static	1.0000
		LIVE	Static	0.5000
		SELFWEIGHT	Static	1.0000
ENVSEIS	ENVE	EX	Combo	1.0000
		EY	Combo	1.0000
		EZ	Combo	1.0000
ENVALL	ENVE	DGRAV	Combo	1.0000
		EX	Combo	1.0000
		EY	Combo	1.0000
XSTCOMBO1	ADD	EXSTAT	Static	1.0000
		EYSTAT	Static	0.3000
		DEAD	Static	1.0000
		LIVE	Static	0.5000
		SELFWEIGHT	Static	1.0000
YSTCOMBO1	ADD	EYSTAT	Static	1.0000
		EXSTAT	Static	0.3000
		DEAD	Static	1.0000
		LIVE	Static	0.5000
		SELFWEIGHT	Static	1.0000
XSTCOMBO2	ADD	EYSTAT	Static	0.3000
		EXSTAT	Static	-1.0000
		DEAD	Static	1.0000
		LIVE	Static	0.5000
		SELFWEIGHT	Static	1.0000
XSTCOMBO3	ADD	EYSTAT	Static	-0.3000
		EXSTAT	Static	1.0000
		DEAD	Static	1.0000
		LIVE	Static	0.5000
		SELFWEIGHT	Static	1.0000
XSTCOMBO4	ADD	EYSTAT	Static	-0.3000
		EXSTAT	Static	-1.0000
		DEAD	Static	1.0000
		LIVE	Static	0.5000
		SELFWEIGHT	Static	1.0000
YSTCOMBO2	ADD	EYSTAT	Static	-1.0000
		EXSTAT	Static	0.3000
		DEAD	Static	1.0000
		LIVE	Static	0.5000
		SELFWEIGHT	Static	1.0000
YSTCOMBO3	ADD	EYSTAT	Static	1.0000
		EXSTAT	Static	-0.3000
		DEAD	Static	1.0000
		LIVE	Static	0.5000
		SELFWEIGHT	Static	1.0000
YSTCOMBO4	ADD	EYSTAT	Static	-1.0000
		EXSTAT	Static	-0.3000
		DEAD	Static	1.0000
		LIVE	Static	0.5000
		SELFWEIGHT	Static	1.0000

ΥΠΟΥΡΓΕΙΟ ΠΑΙΔΕΙΑΣ, ΕΡΕΥΝΑΣ ΚΑΙ ΘΡΗΣΚΕΥΜΑΤΩΝ



COMBO	TYPE	CASE	SCALE
COMBO	TYPE	CASE	FACTOR
ENVSTAT	ENVE	XSTCOMBO1	Combo 1.0000
		YSTCOMBO1	Combo 1.0000
		XSTCOMBO2	Combo 1.0000
		XSTCOMBO3	Combo 1.0000
		XSTCOMBO4	Combo 1.0000
		YSTCOMBO2	Combo 1.0000
		YSTCOMBO3	Combo 1.0000
		YSTCOMBO4	Combo 1.0000
XSTAT	ADD	EXSTAT	Static 1.0000
YSTAT	ADD	EYSTAT	Static 1.0000

Υπουργείο Περιβάλλοντος & Ενέργειας

ΕΓΚΥΡΟ ΑΝΤΙΓΡΑΦΟ	Α/Α Πράξης: 423334
 0003543A7F908851CD669C51C48E7881	Ημ/νία έκδοσης πράξης: 07/06/2022 ΕΛΕΓΧΟΣ ΕΓΚΥΡΟΤΗΤΑΣ https://apps.tee.gr/adeiapublic/faces/searchDocFile

**ΑΠΟΤΕΛΕΣΜΑΤΑ ΑΝΑΛΥΣΗΣ ΜΕ ΔΕΙΚΤΗ
ΕΛΑΦΟΥΣ $K_v=3000 \text{ KN/m}^3$**

Υπουργείο Περιβάλλοντος & Ενέργειας



ΕΓΚΥΡΟ ΑΝΤΙΓΡΑΦΟ	Α/Α Πράξης: 423334
 0003543A7F90B851CD669C51C48E7881	Ημ/νία έκδοσης πράξης: 07/06/2022 ΕΛΕΓΧΟΣ ΕΓΚΥΡΟΤΗΤΑΣ https://apps.tee.gr/adeiapublic/faces/searchDocFile

ΣΥΝΘΗΚΕΣ ΣΤΗΡΙΞΗΣ ($K_v=3000 \text{ KN/m}^3$)



U N C O U P L E D P O I N T S P R I N G A S S I G N M E N T S

STORY	POINT	UX	UY	UZ	RX	RY	RZ
STORY1	76-14	0,0000	0,0000	3000,0000	0,0000	0,0000	0,0000
STORY1	79-14	0,0000	0,0000	3000,0000	0,0000	0,0000	0,0000
STORY1	71-14	0,0000	0,0000	2250,0000	0,0000	0,0000	0,0000
STORY1	70-14	0,0000	0,0000	2250,0000	0,0000	0,0000	0,0000
STORY1	68-14	0,0000	0,0000	3000,0000	0,0000	0,0000	0,0000
STORY1	67-14	0,0000	0,0000	2325,0000	0,0000	0,0000	0,0000
STORY1	81-13	0,0000	0,0000	4300,0000	0,0000	0,0000	0,0000
STORY1	82-14	0,0000	0,0000	1500,0000	0,0000	0,0000	0,0000
STORY1	69-14	0,0000	0,0000	2250,0000	0,0000	0,0000	0,0000
STORY1	72-14	0,0000	0,0000	2250,0000	0,0000	0,0000	0,0000
STORY1	89-7	0,0000	0,0000	0,0000	0,0000	0,0000	0,0000
STORY1	88-7	0,0000	0,0000	0,0000	0,0000	0,0000	0,0000
STORY1	96-6	0,0000	0,0000	2175,0000	0,0000	0,0000	0,0000
STORY1	77-16	0,0000	0,0000	2200,0000	0,0000	0,0000	0,0000
STORY1	78-16	0,0000	0,0000	5100,0000	0,0000	0,0000	0,0000
STORY1	75-10	0,0000	0,0000	3000,0000	0,0000	0,0000	0,0000
STORY1	73-14	0,0000	0,0000	3000,0000	0,0000	0,0000	0,0000
STORY1	66-14	0,0000	0,0000	2325,0000	0,0000	0,0000	0,0000
STORY1	89-10	0,0000	0,0000	960,0000	0,0000	0,0000	0,0000
STORY1	88-10	0,0000	0,0000	2250,0000	0,0000	0,0000	0,0000
STORY1	87-10	0,0000	0,0000	3390,0000	0,0000	0,0000	0,0000
STORY1	97-5	0,0000	0,0000	2700,0000	0,0000	0,0000	0,0000
STORY1	95-7	0,0000	0,0000	825,0000	0,0000	0,0000	0,0000
STORY1	100-7	0,0000	0,0000	675,0000	0,0000	0,0000	0,0000
STORY1	110-7	0,0000	0,0000	3000,0000	0,0000	0,0000	0,0000
STORY1	109-7	0,0000	0,0000	4000,0000	0,0000	0,0000	0,0000
STORY1	108-7	0,0000	0,0000	3600,0000	0,0000	0,0000	0,0000
STORY1	107-7	0,0000	0,0000	3600,0000	0,0000	0,0000	0,0000
STORY1	106-7	0,0000	0,0000	3600,0000	0,0000	0,0000	0,0000
STORY1	105-7	0,0000	0,0000	3600,0000	0,0000	0,0000	0,0000
STORY1	104-7	0,0000	0,0000	3600,0000	0,0000	0,0000	0,0000
STORY1	103-7	0,0000	0,0000	3600,0000	0,0000	0,0000	0,0000
STORY1	102-7	0,0000	0,0000	3000,0000	0,0000	0,0000	0,0000
STORY1	101-7	0,0000	0,0000	1755,0000	0,0000	0,0000	0,0000
STORY1	111-8	0,0000	0,0000	3800,0000	0,0000	0,0000	0,0000
STORY1	127-8	0,0000	0,0000	3800,0000	0,0000	0,0000	0,0000
STORY1	112-8	0,0000	0,0000	3150,0000	0,0000	0,0000	0,0000
STORY1	113-7	0,0000	0,0000	3300,0000	0,0000	0,0000	0,0000
STORY1	128-7	0,0000	0,0000	3300,0000	0,0000	0,0000	0,0000
STORY1	129-7	0,0000	0,0000	3300,0000	0,0000	0,0000	0,0000
STORY1	130-8	0,0000	0,0000	3300,0000	0,0000	0,0000	0,0000
STORY1	114-8	0,0000	0,0000	3300,0000	0,0000	0,0000	0,0000
STORY1	126-7	0,0000	0,0000	3300,0000	0,0000	0,0000	0,0000
STORY1	125-7	0,0000	0,0000	5050,0000	0,0000	0,0000	0,0000
STORY1	124-7	0,0000	0,0000	4000,0000	0,0000	0,0000	0,0000
STORY1	123-7	0,0000	0,0000	3600,0000	0,0000	0,0000	0,0000
STORY1	122-7	0,0000	0,0000	3600,0000	0,0000	0,0000	0,0000
STORY1	121-7	0,0000	0,0000	3600,0000	0,0000	0,0000	0,0000
STORY1	120-7	0,0000	0,0000	3600,0000	0,0000	0,0000	0,0000
STORY1	119-7	0,0000	0,0000	3600,0000	0,0000	0,0000	0,0000
STORY1	118-7	0,0000	0,0000	3600,0000	0,0000	0,0000	0,0000
STORY1	117-7	0,0000	0,0000	3000,0000	0,0000	0,0000	0,0000
STORY1	116-7	0,0000	0,0000	600,0000	0,0000	0,0000	0,0000
STORY1	131-7	0,0000	0,0000	1680,0000	0,0000	0,0000	0,0000
STORY1	132-8	0,0000	0,0000	3000,0000	0,0000	0,0000	0,0000
STORY1	133-8	0,0000	0,0000	2430,0000	0,0000	0,0000	0,0000
STORY1	134-8	0,0000	0,0000	1640,0000	0,0000	0,0000	0,0000
STORY1	135-8	0,0000	0,0000	2500,0000	0,0000	0,0000	0,0000
STORY1	136-8	0,0000	0,0000	2500,0000	0,0000	0,0000	0,0000
STORY1	137-8	0,0000	0,0000	3600,0000	0,0000	0,0000	0,0000
STORY1	138-8	0,0000	0,0000	3600,0000	0,0000	0,0000	0,0000
STORY1	139-8	0,0000	0,0000	3000,0000	0,0000	0,0000	0,0000
STORY1	140-8	0,0000	0,0000	1500,0000	0,0000	0,0000	0,0000
STORY1	141-8	0,0000	0,0000	675,0000	0,0000	0,0000	0,0000
STORY1	142-5	0,0000	0,0000	2685,0000	0,0000	0,0000	0,0000
STORY1	143-5	0,0000	0,0000	2940,0000	0,0000	0,0000	0,0000
STORY1	145-4	0,0000	0,0000	3315,0000	0,0000	0,0000	0,0000
STORY1	146-5	0,0000	0,0000	2685,0000	0,0000	0,0000	0,0000
STORY1	147-5	0,0000	0,0000	2685,0000	0,0000	0,0000	0,0000
STORY1	148-5	0,0000	0,0000	1860,0000	0,0000	0,0000	0,0000
STORY1	149-5	0,0000	0,0000	390,0000	0,0000	0,0000	0,0000
STORY1	150-5	0,0000	0,0000	2280,0000	0,0000	0,0000	0,0000
STORY1	151-4	0,0000	0,0000	810,0000	0,0000	0,0000	0,0000
STORY1	152-5	0,0000	0,0000	2340,0000	0,0000	0,0000	0,0000
STORY1	153-5	0,0000	0,0000	2925,0000	0,0000	0,0000	0,0000
STORY1	156-7	0,0000	0,0000	3000,0000	0,0000	0,0000	0,0000
STORY1	157-7	0,0000	0,0000	3000,0000	0,0000	0,0000	0,0000
STORY1	158-7	0,0000	0,0000	3000,0000	0,0000	0,0000	0,0000
STORY1	159-7	0,0000	0,0000	3000,0000	0,0000	0,0000	0,0000
STORY1	160-7	0,0000	0,0000	3000,0000	0,0000	0,0000	0,0000
STORY1	161-7	0,0000	0,0000	1500,0000	0,0000	0,0000	0,0000
STORY1	162-7	0,0000	0,0000	825,0000	0,0000	0,0000	0,0000
STORY1	163-4	0,0000	0,0000	3000,0000	0,0000	0,0000	0,0000
STORY1	164-3	0,0000	0,0000	3000,0000	0,0000	0,0000	0,0000
STORY1	166-4	0,0000	0,0000	3000,0000	0,0000	0,0000	0,0000
STORY1	168-4	0,0000	0,0000	1500,0000	0,0000	0,0000	0,0000
STORY1	173-14	0,0000	0,0000	3375,0000	0,0000	0,0000	0,0000



UNCOUPLED POINT SPRING ASSIGNMENTS

STORY	POINT	UX	UY	UZ	RX	RY	RZ
STORY1	174-14	0,0000	0,0000	1700,0000	0,0000	0,0000	0,0000
STORY1	169-14	0,0000	0,0000	2250,0000	0,0000	0,0000	0,0000
STORY1	170-12	0,0000	0,0000	2250,0000	0,0000	0,0000	0,0000
STORY1	83-13	0,0000	0,0000	2800,0000	0,0000	0,0000	0,0000
STORY1	171-12	0,0000	0,0000	3375,0000	0,0000	0,0000	0,0000
STORY1	172-12	0,0000	0,0000	1680,0000	0,0000	0,0000	0,0000
STORY1	176-5	0,0000	0,0000	3000,0000	0,0000	0,0000	0,0000
STORY1	177-5	0,0000	0,0000	2940,0000	0,0000	0,0000	0,0000
STORY1	178-5	0,0000	0,0000	3000,0000	0,0000	0,0000	0,0000
STORY1	179-5	0,0000	0,0000	2625,0000	0,0000	0,0000	0,0000
STORY1	180-5	0,0000	0,0000	1155,0000	0,0000	0,0000	0,0000
STORY1	182-5	0,0000	0,0000	2610,0000	0,0000	0,0000	0,0000
STORY1	181-5	0,0000	0,0000	1140,0000	0,0000	0,0000	0,0000
STORY1	183-5	0,0000	0,0000	3300,0000	0,0000	0,0000	0,0000
STORY1	186-5	0,0000	0,0000	3525,0000	0,0000	0,0000	0,0000
STORY1	187-5	0,0000	0,0000	2250,0000	0,0000	0,0000	0,0000
STORY1	190-5	0,0000	0,0000	1950,0000	0,0000	0,0000	0,0000
STORY1	192-5	0,0000	0,0000	2550,0000	0,0000	0,0000	0,0000
STORY1	191-5	0,0000	0,0000	2550,0000	0,0000	0,0000	0,0000
STORY1	193-5	0,0000	0,0000	1950,0000	0,0000	0,0000	0,0000
STORY1	195-5	0,0000	0,0000	2100,0000	0,0000	0,0000	0,0000
STORY1	194-5	0,0000	0,0000	2100,0000	0,0000	0,0000	0,0000
STORY1	198-5	0,0000	0,0000	3000,0000	0,0000	0,0000	0,0000
STORY1	199-5	0,0000	0,0000	3600,0000	0,0000	0,0000	0,0000
STORY1	200-5	0,0000	0,0000	3000,0000	0,0000	0,0000	0,0000
STORY1	201-5	0,0000	0,0000	2325,0000	0,0000	0,0000	0,0000
STORY1	241-2	0,0000	0,0000	3000,0000	0,0000	0,0000	0,0000
BASE	1	0,0000	0,0000	3255,0000	0,0000	0,0000	0,0000
BASE	2	0,0000	0,0000	480,0000	0,0000	0,0000	0,0000
BASE	3	0,0000	0,0000	3735,0000	0,0000	0,0000	0,0000
BASE	4	0,0000	0,0000	3735,0000	0,0000	0,0000	0,0000
BASE	5	0,0000	0,0000	3600,0000	0,0000	0,0000	0,0000
BASE	6	0,0000	0,0000	3600,0000	0,0000	0,0000	0,0000
BASE	7	0,0000	0,0000	3600,0000	0,0000	0,0000	0,0000
BASE	8	0,0000	0,0000	3600,0000	0,0000	0,0000	0,0000
BASE	9	0,0000	0,0000	3600,0000	0,0000	0,0000	0,0000
BASE	10	0,0000	0,0000	3600,0000	0,0000	0,0000	0,0000
BASE	11	0,0000	0,0000	3600,0000	0,0000	0,0000	0,0000
BASE	12	0,0000	0,0000	3600,0000	0,0000	0,0000	0,0000
BASE	13	0,0000	0,0000	3600,0000	0,0000	0,0000	0,0000
BASE	14	0,0000	0,0000	3600,0000	0,0000	0,0000	0,0000
BASE	15	0,0000	0,0000	2610,0000	0,0000	0,0000	0,0000
BASE	16	0,0000	0,0000	2055,0000	0,0000	0,0000	0,0000
BASE	17	0,0000	0,0000	3480,0000	0,0000	0,0000	0,0000
BASE	18	0,0000	0,0000	3870,0000	0,0000	0,0000	0,0000
BASE	19	0,0000	0,0000	3480,0000	0,0000	0,0000	0,0000
BASE	20	0,0000	0,0000	3690,0000	0,0000	0,0000	0,0000
BASE	21	0,0000	0,0000	3600,0000	0,0000	0,0000	0,0000
BASE	22	0,0000	0,0000	3600,0000	0,0000	0,0000	0,0000
BASE	23	0,0000	0,0000	3480,0000	0,0000	0,0000	0,0000
BASE	24	0,0000	0,0000	3690,0000	0,0000	0,0000	0,0000
BASE	25	0,0000	0,0000	3480,0000	0,0000	0,0000	0,0000
BASE	26	0,0000	0,0000	3690,0000	0,0000	0,0000	0,0000
BASE	27	0,0000	0,0000	1575,0000	0,0000	0,0000	0,0000
BASE	28	0,0000	0,0000	3600,0000	0,0000	0,0000	0,0000
BASE	29	0,0000	0,0000	2700,0000	0,0000	0,0000	0,0000
BASE	30	0,0000	0,0000	3150,0000	0,0000	0,0000	0,0000
BASE	31	0,0000	0,0000	3600,0000	0,0000	0,0000	0,0000
BASE	32	0,0000	0,0000	3600,0000	0,0000	0,0000	0,0000
BASE	33	0,0000	0,0000	3600,0000	0,0000	0,0000	0,0000
BASE	34	0,0000	0,0000	3600,0000	0,0000	0,0000	0,0000
BASE	35	0,0000	0,0000	3600,0000	0,0000	0,0000	0,0000
BASE	36	0,0000	0,0000	3600,0000	0,0000	0,0000	0,0000
BASE	37	0,0000	0,0000	3600,0000	0,0000	0,0000	0,0000
BASE	38	0,0000	0,0000	3600,0000	0,0000	0,0000	0,0000
BASE	39	0,0000	0,0000	3600,0000	0,0000	0,0000	0,0000
BASE	40	0,0000	0,0000	3600,0000	0,0000	0,0000	0,0000
BASE	41	0,0000	0,0000	3000,0000	0,0000	0,0000	0,0000
BASE	42	0,0000	0,0000	4800,0000	0,0000	0,0000	0,0000
BASE	43	0,0000	0,0000	1500,0000	0,0000	0,0000	0,0000
BASE	44	0,0000	0,0000	1500,0000	0,0000	0,0000	0,0000
BASE	46	0,0000	0,0000	3150,0000	0,0000	0,0000	0,0000
BASE	47	0,0000	0,0000	3150,0000	0,0000	0,0000	0,0000
BASE	48	0,0000	0,0000	3150,0000	0,0000	0,0000	0,0000
BASE	49	0,0000	0,0000	3150,0000	0,0000	0,0000	0,0000
BASE	50	0,0000	0,0000	3150,0000	0,0000	0,0000	0,0000
BASE	51	0,0000	0,0000	3150,0000	0,0000	0,0000	0,0000
BASE	52	0,0000	0,0000	1575,0000	0,0000	0,0000	0,0000
BASE	53	0,0000	0,0000	1920,0000	0,0000	0,0000	0,0000
BASE	54	0,0000	0,0000	3390,0000	0,0000	0,0000	0,0000
BASE	55	0,0000	0,0000	3150,0000	0,0000	0,0000	0,0000
BASE	56	0,0000	0,0000	3150,0000	0,0000	0,0000	0,0000
BASE	57	0,0000	0,0000	3000,0000	0,0000	0,0000	0,0000
BASE	58	0,0000	0,0000	3390,0000	0,0000	0,0000	0,0000
BASE	59	0,0000	0,0000	3945,0000	0,0000	0,0000	0,0000
BASE	60	0,0000	0,0000	2835,0000	0,0000	0,0000	0,0000
BASE	61	0,0000	0,0000	3150,0000	0,0000	0,0000	0,0000

U N C O U P L E D P O I N T S P R I N G A S S I G N M E N T S

STORY	POINT	UX	UY	UZ	RX	RY	RZ
BASE	62	0,0000	0,0000	3150,0000	0,0000	0,0000	0,0000
BASE	63	0,0000	0,0000	3600,0000	0,0000	0,0000	0,0000
BASE	64	0,0000	0,0000	1950,0000	0,0000	0,0000	0,0000
BASE	65	0,0000	0,0000	1260,0000	0,0000	0,0000	0,0000
BASE	98	0,0000	0,0000	3735,0000	0,0000	0,0000	0,0000
BASE	99	0,0000	0,0000	3525,0000	0,0000	0,0000	0,0000
BASE	115	0,0000	0,0000	3525,0000	0,0000	0,0000	0,0000

ΥΠΟΥΡΓΕΙΟ ΠΕΡΙΒΑΛΛΟΝΤΟΣ & ΕΝΕΡΓΕΙΑΣ



ΕΓΚΥΡΟ ΑΝΤΙΓΡΑΦΟ	Α/Α Πράξης: 423334
 0003543A7F90B851CD669C51C48E7881	Ημ/νία έκδοσης πράξης: 07/06/2022 ΕΛΕΓΧΟΣ ΕΓΚΥΡΟΤΗΤΑΣ https://apps.tee.gr/adeiapublic/faces/searchDocFile

**ΟΡΙΖΟΝΤΙΕΣ ΜΕΤΑΚΙΝΗΣΕΙΣ ΣΕ
ΧΑΡΑΚΤΗΡΙΣΤΙΚΕΣ ΘΕΣΕΙΣ**

Υπουργείο Περιβάλλοντος & Ενέργειας



000354347908851CD669C51C48E7881

Story	Point	Load	UX	UY	UZ	RX	RY	RZ
STORY5	78-5	DEAD	0.0008	0.001	-0.0039	-0.00008	0.00006	-0.00001
STORY5	78-5	LIVE	0.0012	0.0019	-0.0047	-0.00017	0.0001	-0.00002
STORY5	78-5	EXSTAT	0.0159	0.0011	-0.0195	-0.00009	0.0014	-0.00011
STORY5	78-5	EYSTAT	-0.0001	0.0578	-0.0098	-0.00523	-0.00004	-0.00093
STORY5	78-5	SELFWEIGHT	0.0085	0.0303	-0.0451	-0.00279	0.00079	0
STORY3	2-louv	DEAD	0.0002	0.0003	-0.0012	-0.00009	0.00008	0
STORY3	2-louv	LIVE	0.0004	0.0004	-0.0005	-0.00008	0.00008	0.00001
STORY3	2-louv	EXSTAT	0.0054	-0.002	0.0138	0.0004	0.00054	-0.00067
STORY3	2-louv	EYSTAT	-0.0011	0.011	-0.013	-0.00157	-0.00035	0.00017
STORY3	2-louv	SELFWEIGHT	0.0015	0.0049	-0.0195	-0.0008	0.00023	-0.00009
STORY3	29-louv	DEAD	-0.0001	0.0003	-0.0006	-0.00004	-0.00001	0
STORY3	29-louv	LIVE	0.0002	0.0004	0.0002	-0.00006	0.00003	0
STORY3	29-louv	EXSTAT	0.0042	-0.0019	0.0103	0.00032	0.00067	-0.00017
STORY3	29-louv	EYSTAT	-0.0004	0.0111	0.0038	-0.00173	-0.00002	0.00073
STORY3	29-louv	SELFWEIGHT	-0.0029	0.0048	-0.0116	-0.00076	-0.00054	-0.00003
STORY3	112-4	DEAD	0.0004	0.0005	-0.0029	-0.00009	0.00005	0
STORY3	112-4	LIVE	0.0006	0.0009	-0.0029	-0.00018	0.0001	0
STORY3	112-4	EXSTAT	0.0071	0.0005	-0.0175	-0.00015	0.00123	-0.00014
STORY3	112-4	EYSTAT	-0.0064	0.0267	0.0402	-0.00498	-0.00123	-0.0006
STORY3	112-4	SELFWEIGHT	0.0023	0.0143	-0.0168	-0.00273	0.00042	-0.00015

ΥΠΟΥΡΓΕΙΟ ΠΕΡΙΒΑΛΛΟΝΤΟΣ ΚΑΙ ΚΛΙΜΑΤΟΣ





ETABS

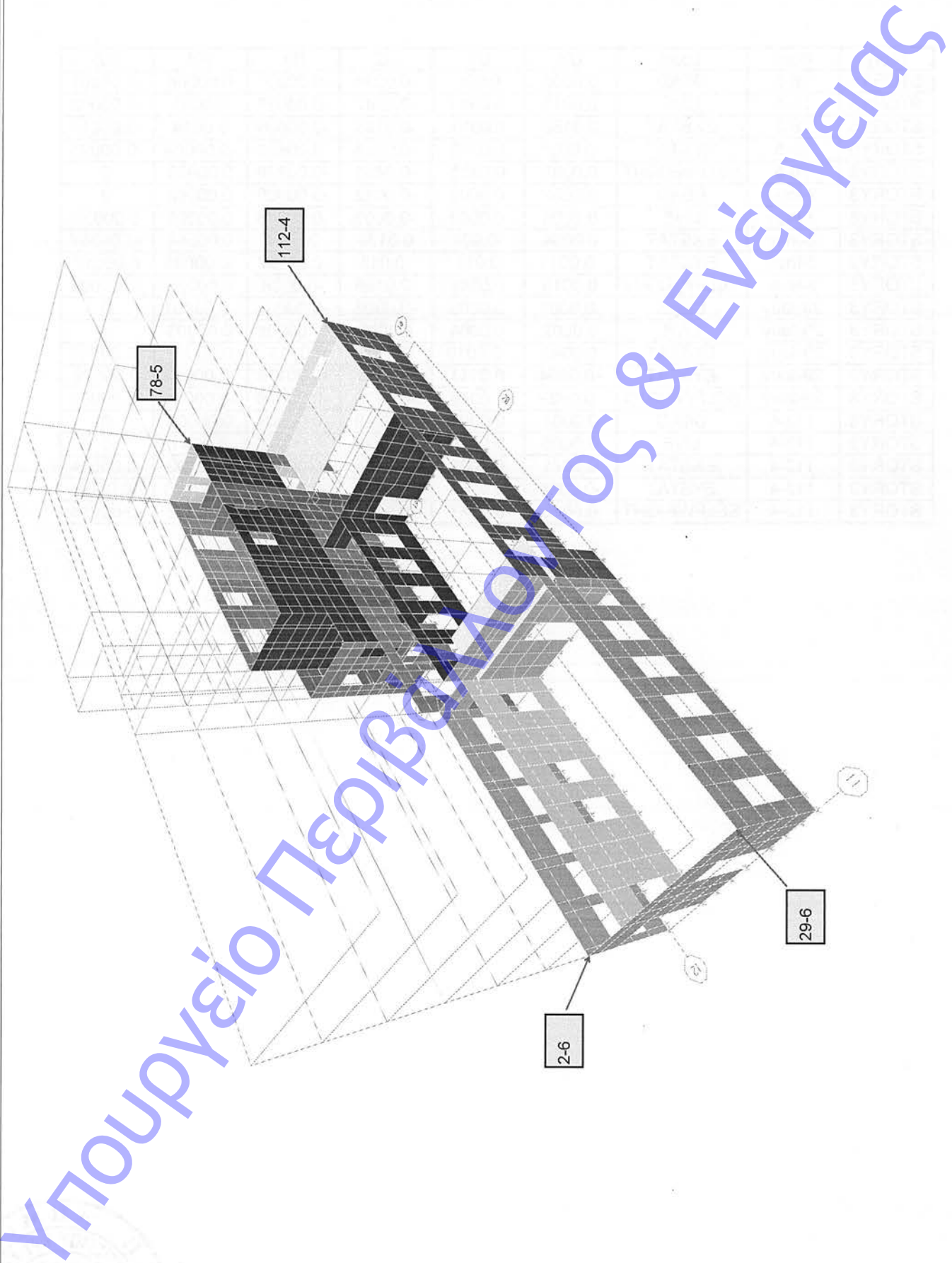

ΕΓΚΥΡΟ ΑΝΤΙΓΡΑΦΟ	Α/Α Πράξης: 423334
 0003543A7F90B851CD669C51C48E7881	Ημ/νία έκδοσης πράξης: 07/06/2022 ΕΛΕΓΧΟΣ ΕΓΚΥΡΟΤΗΤΑΣ https://apps.tee.gr/adeiapublic/faces/searchDocFile

Υπουργείο Περιβάλλοντος & Ενέργειας

ΧΡΩΜΑΤΟΓΡΑΦΙΚΗ ΑΠΕΙΚΟΝΙΣΗ ΤΑΣΕΩΝ





0003543A7F908851CD669C51C48E7881

ΤΟ ΜΟΒ ΑΝΤΙΣΤΟΙΧΕΙ ΣΕ ΕΦΕΚΛΙΣΜΟ
+1000KN/m2
ΤΟ ΚΟΚΚΙΝΟ ΑΝΤΙΣΤΟΙΧΕΙ ΣΕ ΤΗΛΙΨΙ
-1000KN/m2.
ΜΑΧ ΕΠΙΤΡΕΠΟΜΕΝΗ ΤΗΛΙΨΤΙΚΗ
ΤΑΣΗ -7300KN/m2
Ο ΕΦΕΚΛΙΣΜΟΣ ΘΑ ΠΑΡΑΛΗΦΤΗΙ
ΑΠΟ ΤΟΝ ΤΟΡΟΤΗΤΟΥΜΕΝΟ
ΟΠΛΙΣΜΟ

10 OPSI 135MON+150KIN-S22

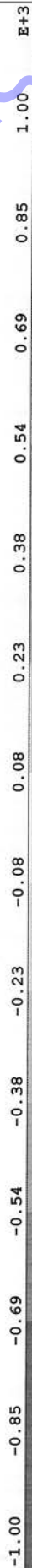
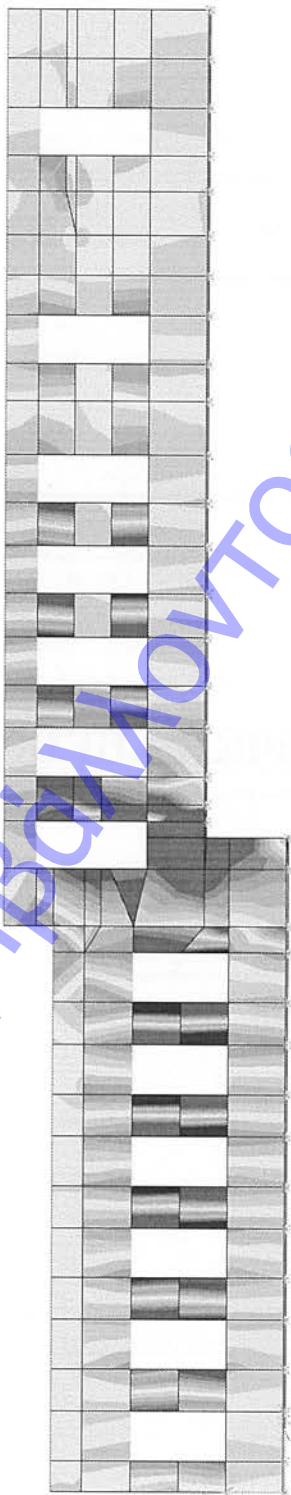

10 OPSI SEISMOS X+ S22

ΤΟ ΜΟΒ ΑΝΤΙΣΤΟΙΧΕΙ ΣΕ ΕΦΕΚΛΙΣΜΟ
 +1000KN/m2
 ΤΟ ΚΟΚΚΙΝΟ ΑΝΤΙΣΤΟΙΧΕΙ ΣΕ ΘΛΙΨΙ
 -1000KN/m2.
 ΜΑΧ ΕΠΙΤΡΕΠΟΜΕΝΗ ΘΛΙΨΤΙΚΗ
 ΤΑΣΗ -7300KN/m2
 Ο ΕΦΕΚΛΙΣΜΟΣ ΘΑ ΠΑΡΑΛΗΨΤΗΙ
 ΑΠΟ ΤΟΝ ΤΟΡΟΤΗΤΟΥΜΕΝΟ
 ΟΠΛΙΣΜΟ

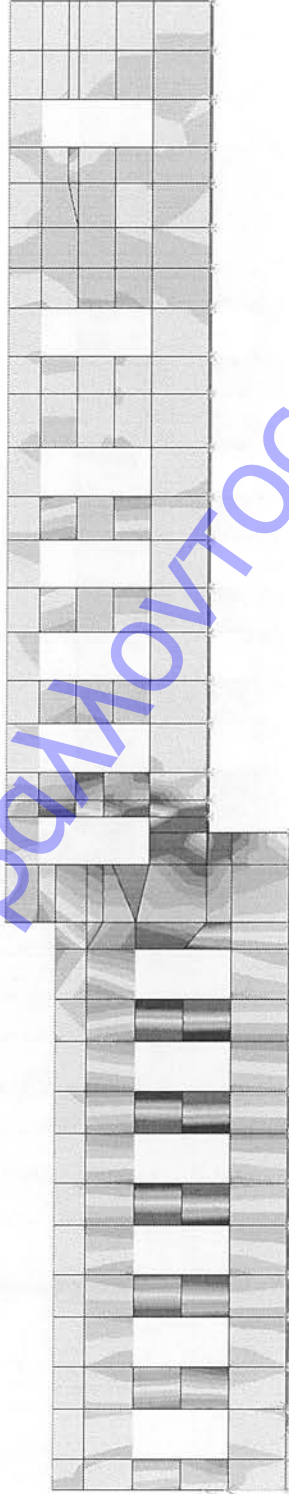

-0.85 -0.69 -0.54 -0.38 -0.23 -0.08 0.08 0.23 0.38 0.54 0.69 0.85 1.00 E+3





0003543A7F908851CD669C51C48E7881

Ημ/νία έκδοσης πράξης: 07/06/2022
 ΕΛΕΓΧΟΣ ΕΓΚΥΡΟΤΗΤΑΣ
<https://apps.tee.gr/adeiapublic/faces/searchDocFile>

ΤΟ ΜΟΒ ΑΝΤΙΣΤΟΙΧΕΙ ΣΕ ΕΦΕΚΛΙΣΜΟ
 +1000KN/m²
 ΤΟ ΚΟΚΚΙΝΟ ΑΝΤΙΣΤΟΙΧΕΙ ΣΕ ΤΗΛΙΨΙ
 -1000KN/m².
 ΜΑΧ ΕΠΙΤΡΕΠΟΜΕΝΗ ΤΗΛΙΨΤΙΚΗ
 ΤΑΣΗ -7300KN/m²
 Ο ΕΦΕΚΛΙΣΜΟΣ ΘΑ ΠΑΡΑΛΗΨΤΗΙ
 ΑΠΟ ΤΟΝ ΤΟΡΟΤΗΤΟΥΜΕΝΟ
 ΟΠΛΙΣΜΟ

10 OPSI SEISMOS X- S22

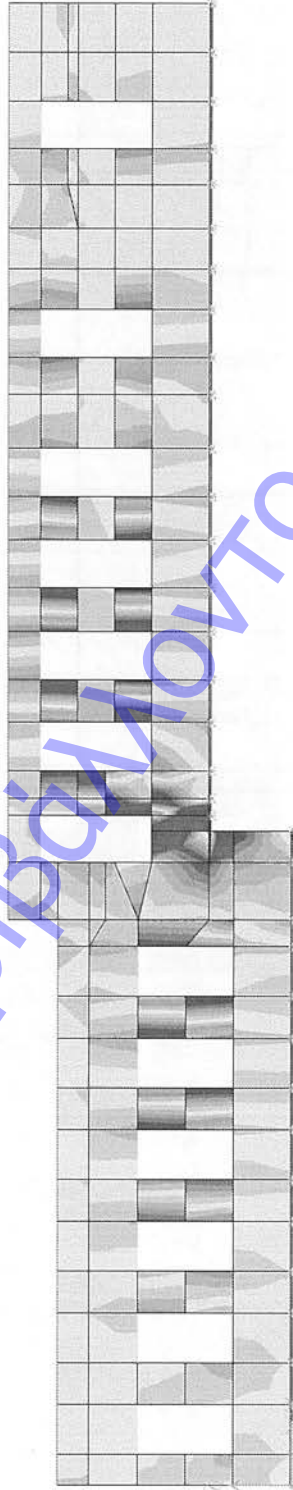

-1.00 -0.85 -0.69 -0.54 -0.38 -0.23 -0.08 0.08 0.23 0.38 0.54 0.69 0.85 1.00 E+3

12 OPSI 135MON+150KIN-S22

ΤΟ ΜΟΒ ΑΝΤΙΣΤΟΙΧΕΙ ΣΕ ΕΦΕΚΛΙΣΜΟ
 +1000KN/m2
 ΤΟ ΚΟΚΚΙΝΟ ΑΝΤΙΣΤΟΙΧΕΙ ΣΕ ΤΗΛΙΠΣΙ
 -1000KN/m2.
 ΜΑΧ ΕΠΙΤΡΕΠΟΜΕΝΗ ΤΗΛΙΠΤΙΚΗ
 ΤΑΣΗ -7300KN/m2
 Ο ΕΦΕΚΛΙΣΜΟΣ ΘΑ ΠΑΡΑΛΗΦΤΗΘΕΙ
 ΑΠΟ ΤΟΝ ΤΟΡΟΤΗΤΟΥΜΕΝΟ
 ΟΠΛΙΣΜΟ

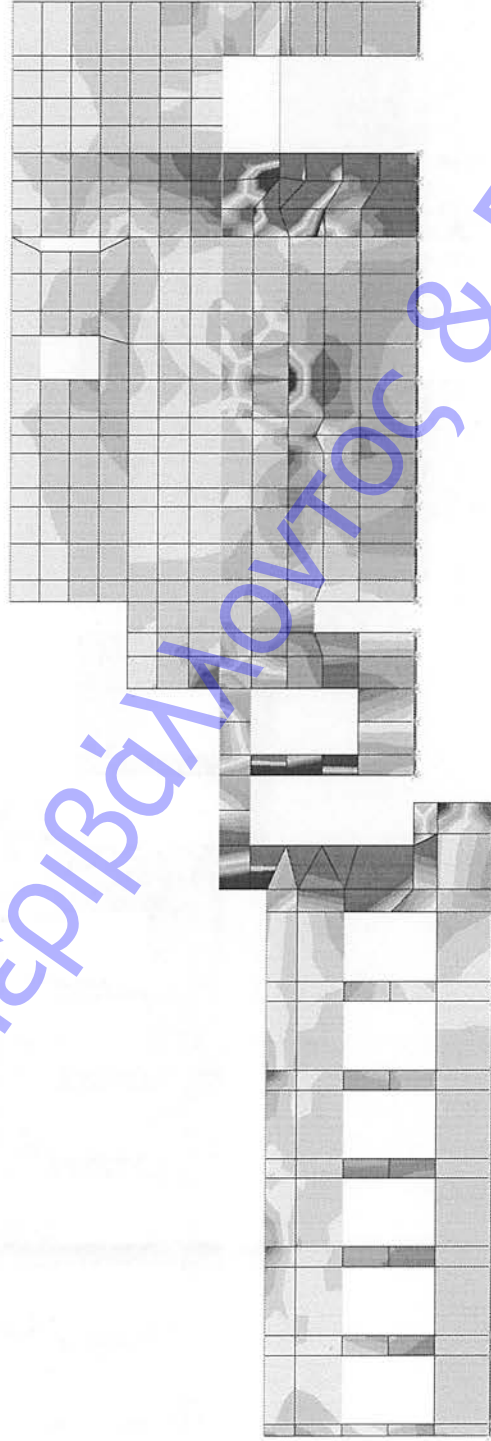

Υπουργείο Περιβάλλοντος & Ενέργειας





0003543A7F908851CD669C51C48E7881

Ημ/νία έκδοσης πράξης: 07/06/2022
 ΕΛΕΓΧΟΣ ΕΓΚΥΡΟΤΗΤΑΣ
<https://apps.tee.gr/adeiapublic/faces/searchDocFile>

ETABS

12 OPSI SEISMOS X+ S22

ΤΟ ΜΟΒ ΑΝΤΙΣΤΟΙΧΕΙ ΣΕ ΕΦΕΚΛΙΣΜΟ
 +1000KN/m2
 ΤΟ ΚΟΚΚΙΝΟ ΑΝΤΙΣΤΟΙΧΕΙ ΣΕ ΤΗΛΙΠΣΙ
 -1000KN/m2.
 MAX EPITREPOMENH THLIPTIKH
 TASH -7300KN/m2
 Ο ΕΦΕΚΛΙΣΜΟΣ ΘΑ ΠΑΡΑΛΗΦΤΗΘΕΙ
 ΑΠΟ ΤΟΝ ΤΟΡΟΤΗΤΟΥΜΕΝΟ
 ΟΠΛΙΣΜΟ

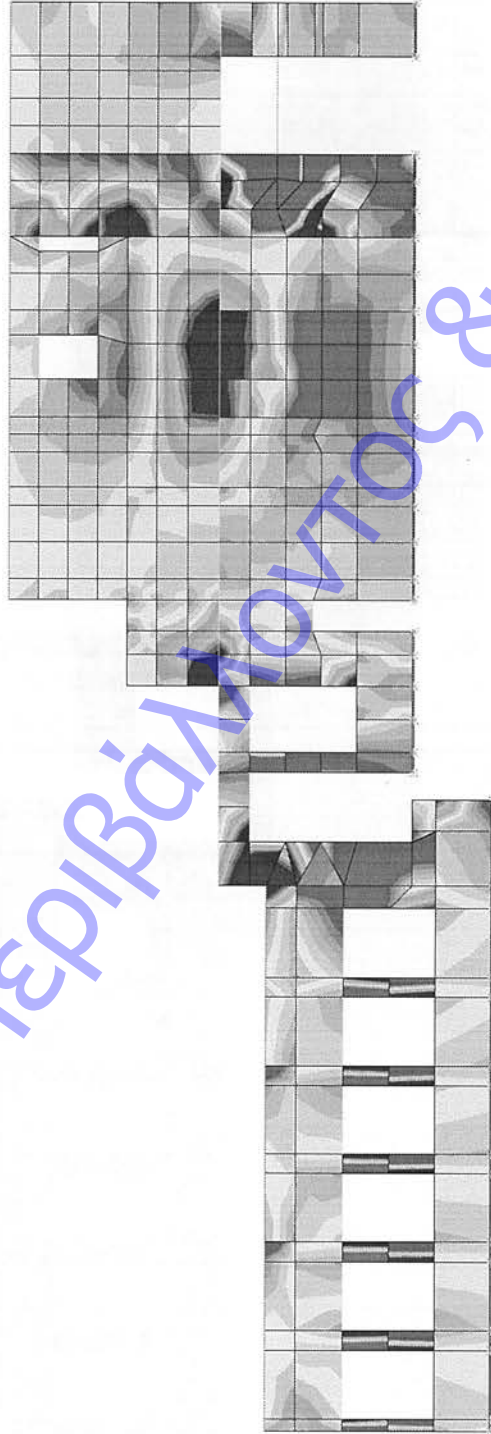

-1.00 -0.85 -0.69 -0.54 -0.38 -0.23 -0.08 0.08 0.23 0.38 0.54 0.69 0.85 1.00 E+3

ETABS

12 OPSI SEISMOS X- S22

ΤΟ ΜΟΒ ΑΝΤΙΣΤΟΙΧΕΙ ΣΕ ΕΦΕΚΛΙΣΜΟ
+1000KN/m2
ΤΟ ΚΟΚΚΙΝΟ ΑΝΤΙΣΤΟΙΧΕΙ ΣΕ ΤΗΛΙΨΙ
-1000KN/m2.
ΜΑΧ ΕΠΙΤΡΕΠΟΜΕΝΗ ΤΗΛΙΨΤΙΚΗ
ΤΑΣΗ -7300KN/m2
Ο ΕΦΕΚΛΙΣΜΟΣ ΘΑ ΠΑΡΑΛΗΦΤΗΙ
ΑΠΟ ΤΟΝ ΤΟΡΟΤΗΤΟΥΜΕΝΟ
ΟΠΛΙΣΜΟ

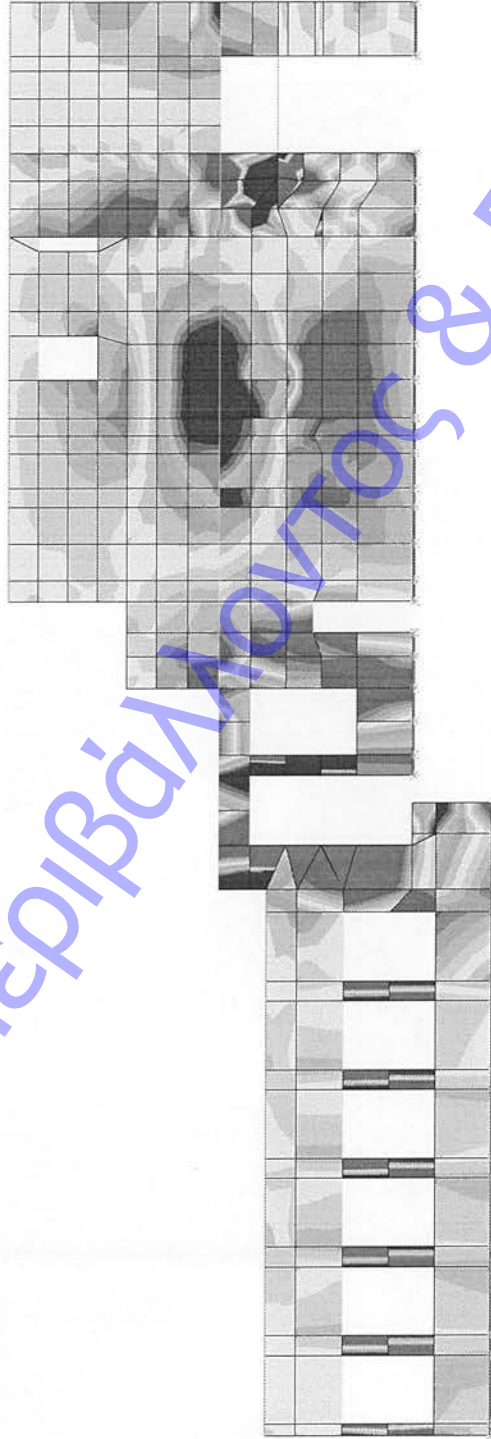

0.85 0.69 0.54 0.38 0.23 0.08 -0.08 -0.23 -0.38 -0.54 -0.69 -0.85 E+3 1.00



0003543A7F908851CD669C51C48E7881



ETABS

16 OPSI 135MON+150KIN-S22

ΤΟ ΜΟΒ ΑΝΤΙΣΤΟΙΧΕΙ ΣΕ
ΕΦΕΚΛΙΣΜΟ +1000KN/m2
ΤΟ ΚΟΚΚΙΝΟ ΑΝΤΙΣΤΟΙΧΕΙ
ΣΕ ΤΗΛΙΨΙ -1000KN/m2.
ΜΑΧ ΕΠΙΤΡΕΠΟΜΕΝΗ
ΤΗΛΙΨΤΙΚΗ ΤΑΣΗ -7300KN/
m2
Ο ΕΦΕΚΛΙΣΜΟΣ ΘΑ
ΠΑΡΑΛΗΨΤΗΙ ΑΠΟ ΤΟΝ
ΤΟΡΟΤΗΤΟΥΜΕΝΟ
ΟΠΛΙΣΜΟ

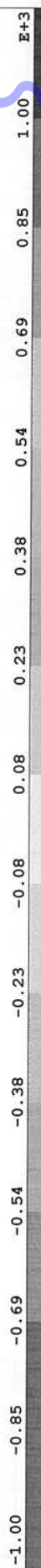
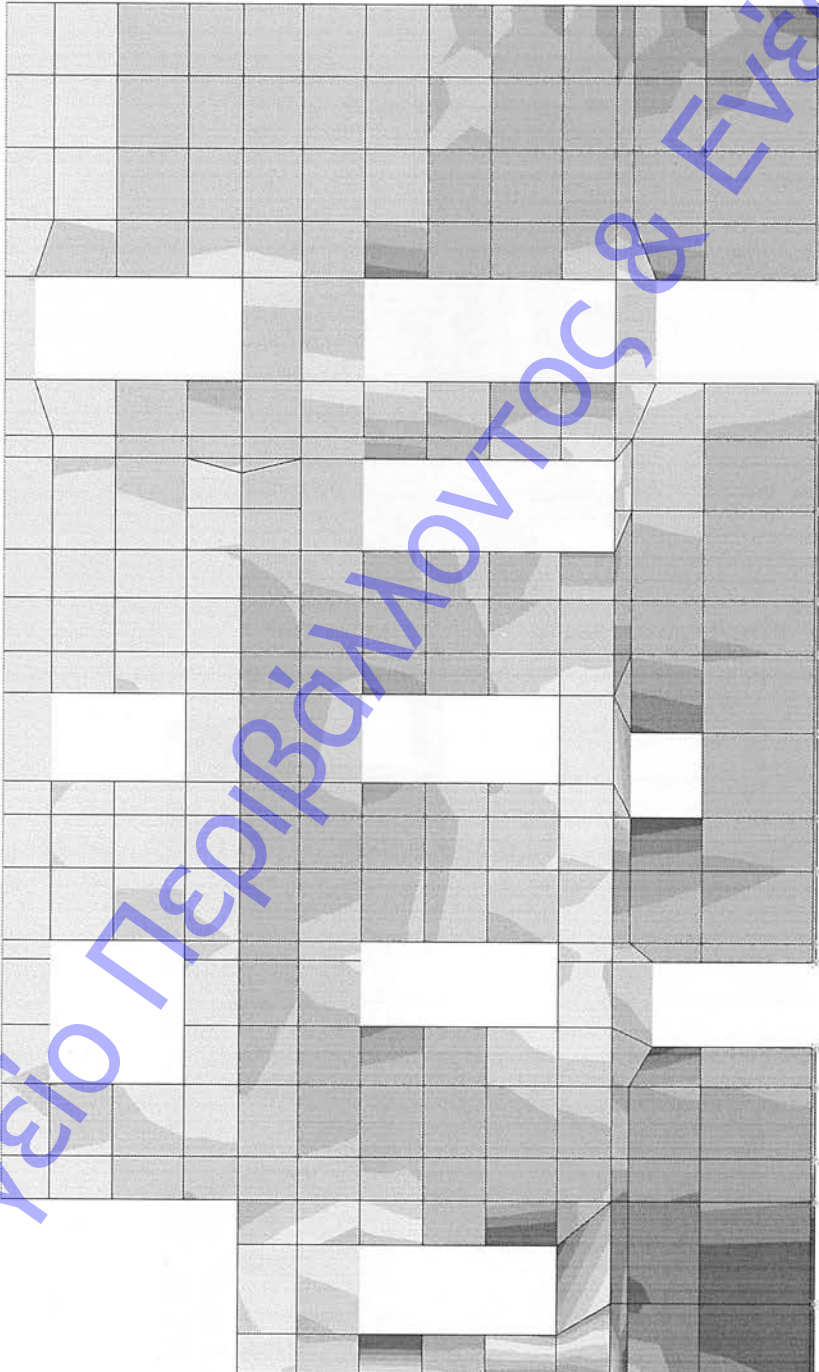

ΥΠΟΥΡΓΕΙΟ ΠΕΡΙΒΑΛΛΟΝΤΟΣ & ΕΝΕΡΓΕΙΑΣ

ETABS

16 OPSI SEISMOS X+ S22

ΤΟ ΜΟΒ ΑΝΤΙΣΤΟΙΧΕΙ ΣΕ
ΕΦΕΚΛΙΣΜΟ +1000KN/m2
ΤΟ ΚΟΚΚΙΝΟ ΑΝΤΙΣΤΟΙΧΕΙ
ΣΕ ΤΗΛΙΨΙ -1000KN/m2.
ΜΑΧ ΕΠΙΤΡΕΠΟΜΕΝΗ
ΤΗΛΙΨΤΙΚΗ ΤΑΣΗ -7300KN/
m2
Ο ΕΦΕΚΛΙΣΜΟΣ ΘΑ
ΠΑΡΑΛΗΦΤΗΙ ΑΠΟ ΤΟΝ
ΤΟΡΟΤΗΤΟΥΜΕΝΟ
ΟΡΛΙΣΜΟ

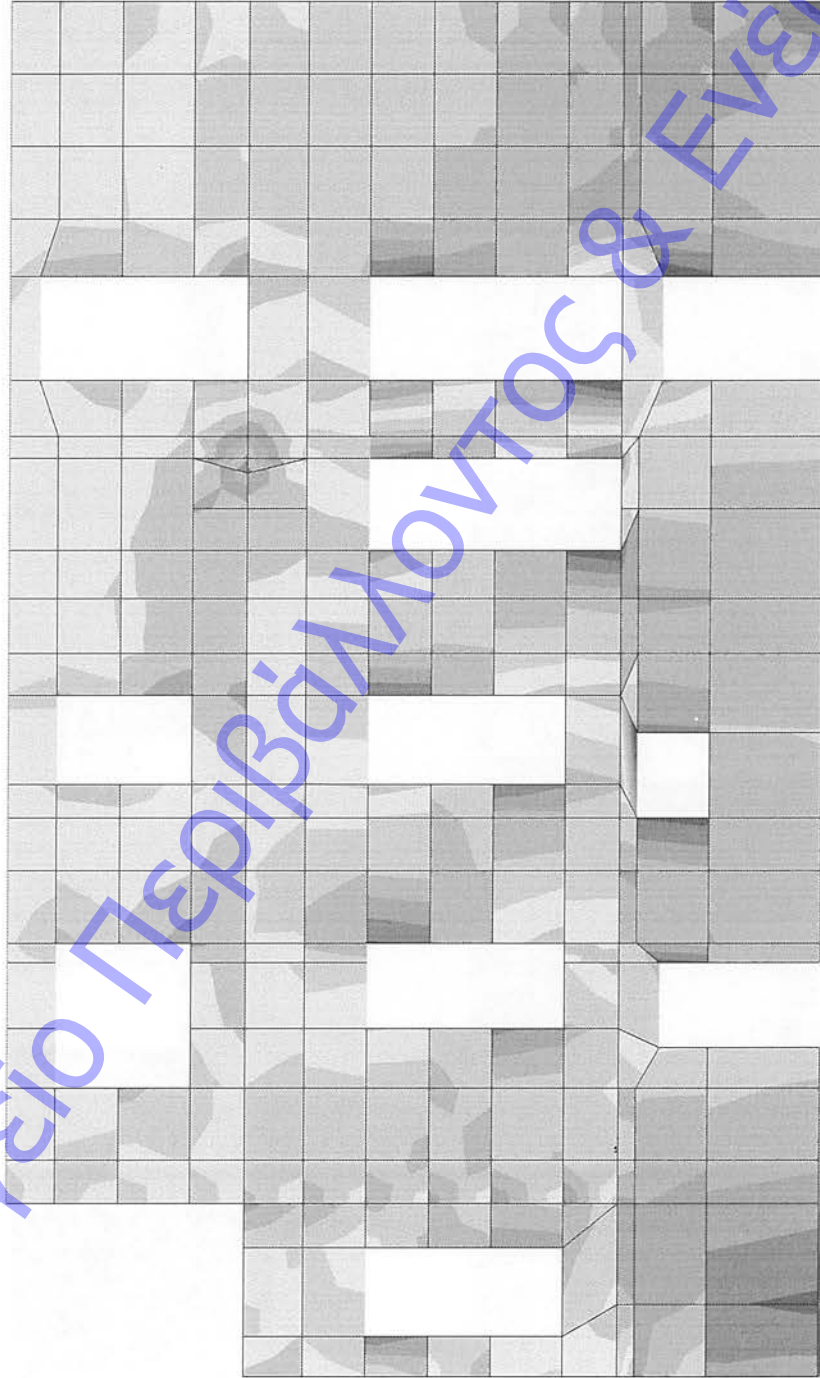

-0.85 -0.69 -0.54 -0.38 -0.23 -0.08 0.08 0.23 0.38 0.54 0.69 0.85 1.00 E+3



0003543A7F908851CD669C51C48E7881



ΤΟ ΜΟΒ ΑΝΤΙΣΤΟΙΧΕΙ ΣΕ
ΕΦΕΚΛΙΣΜΟ +1000KN/m2
ΤΟ ΚΟΚΚΙΝΟ ΑΝΤΙΣΤΟΙΧΕΙ
ΣΕ ΤΗΛΙΨΙ -1000KN/m2.
ΜΑΧ ΕΠΙΤΡΕΠΟΜΕΝΗ
ΤΗΛΙΨΤΙΚΗ ΤΑΣΗ -7300KN/
m2
Ο ΕΦΕΚΛΙΣΜΟΣ ΘΑ
ΠΑΡΑΛΗΦΤΗΙ ΑΠΟ ΤΟΝ
ΤΟΠΟΘΕΤΟΥΜΕΝΟ
ΟΠΛΙΣΜΟ

16 OPSI SEISMOS X- S22

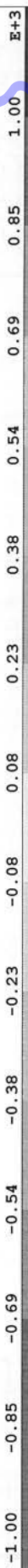
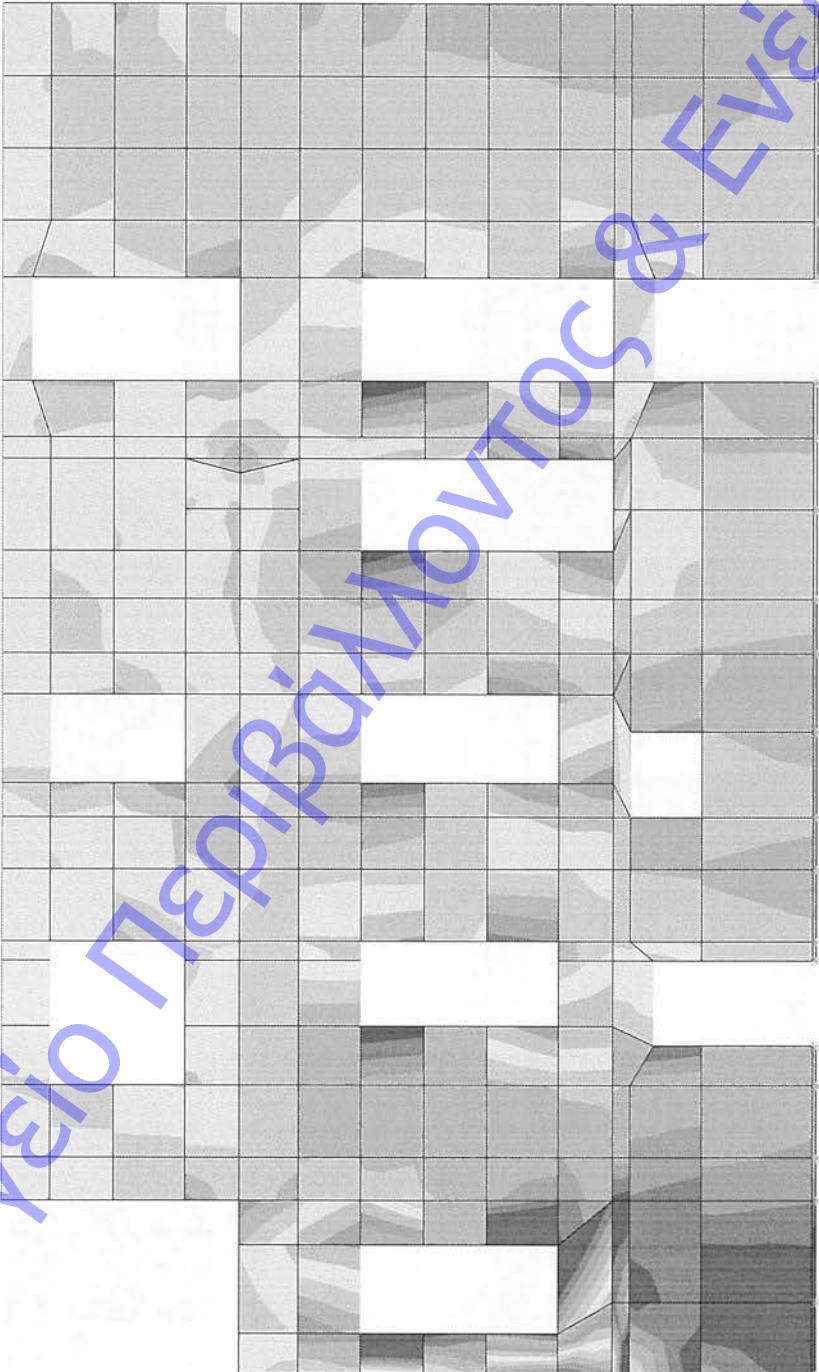

19 OPSI 135MON+150KIN-S22

ΤΟ ΜΟΒ ΑΝΤΙΣΤΟΙΧΕΙ ΣΕ ΕΦΕΚΛΙΣΜΟ
+1000KN/m2
ΤΟ ΚΟΚΚΙΝΟ ΑΝΤΙΣΤΟΙΧΕΙ ΣΕ ΤΗΛΙΠΣΙ
-1000KN/m2.
ΜΑΧ ΕΠΙΤΡΕΠΟΜΕΝΗ ΤΗΛΙΠΤΙΚΗ
ΤΑΣΗ -7300KN/m2
Ο ΕΦΕΚΛΙΣΜΟΣ ΘΑ ΠΑΡΑΛΗΦΤΗΘΕΙ
ΑΠΟ ΤΟΝ ΤΟΡΟΤΗΤΟΥΜΕΝΟ
ΟΠΛΙΣΜΟ

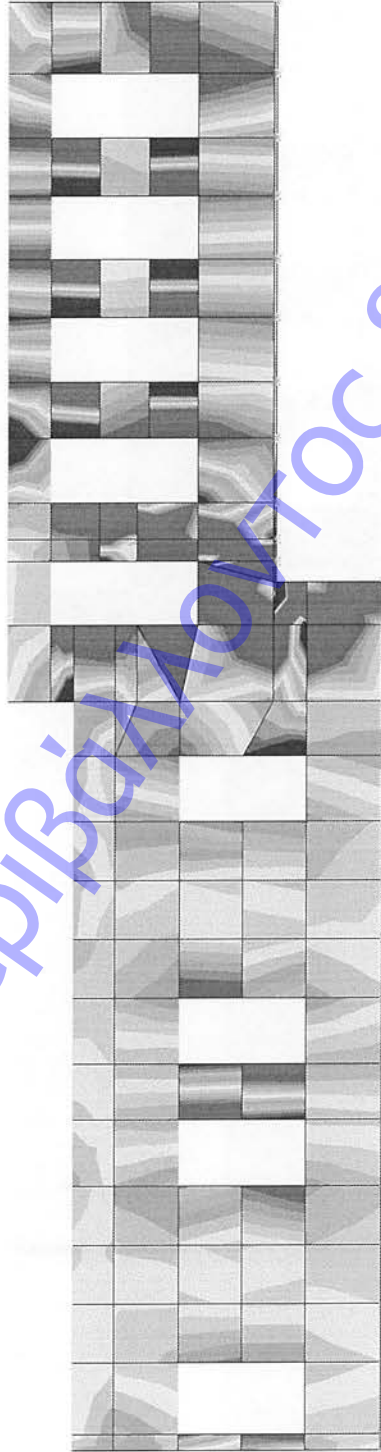

-0.85 -0.69 -0.54 -0.38 -0.23 -0.08 0.08 0.23 0.38 0.54 0.69 0.85 1.00 E+3





0003543A7F908851CD669C51C48E7881

Ημ/νία έκδοσης πράξης: 07/06/2022
 ΕΛΕΓΧΟΣ ΕΓΚΥΡΟΤΗΤΑΣ
<https://apps.tee.gr/adeiapublic/faces/searchDocFile>

ΤΟ ΜΟΒ ΑΝΤΙΣΤΟΙΧΕΙ ΣΕ ΕΦΕΚΛΙΣΜΟ
 +1000KN/m2
 ΤΟ ΚΟΚΚΙΝΟ ΑΝΤΙΣΤΟΙΧΕΙ ΣΕ ΤΗΛΙΨΙ
 -1000KN/m2.
 ΜΑΧ ΕΠΙΤΡΕΠΟΜΕΝΗ ΤΗΛΙΨΤΙΚΗ
 ΤΑΣΗ -7300KN/m2
 Ο ΕΦΕΚΛΙΣΜΟΣ ΘΑ ΠΑΡΑΛΗΨΤΗΙ
 ΑΠΟ ΤΟΝ ΤΟΡΟΤΗΤΟΥΜΕΝΟ
 ΟΠΛΙΣΜΟ

19 OPSI SEISMOS X+ S22

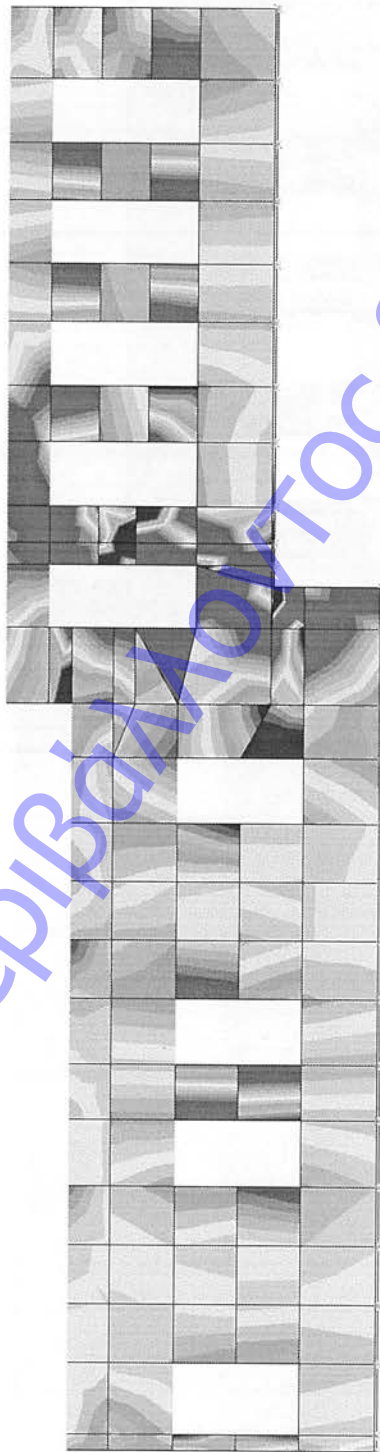

-1.00 -0.85 -0.69 -0.54 -0.38 -0.23 -0.08 0.08 0.23 0.38 0.54 0.69 0.85 1.00 E+3

19 OPSI SEISMOS X- S22

TO MOB ANTISTOIXEI SE EFEKLISMO
+1000KN/m2
TO KOKKINO ANTISTOIXEI SE THLIPSI
-1000KN/m2.
MAX EPITREPOMENH THLIPTIKH
TASH -7300KN/m2
O EFEKLISMOS THA PARALHFTHEI
APO TON TOROTHETOYMEHO
OPLISMO

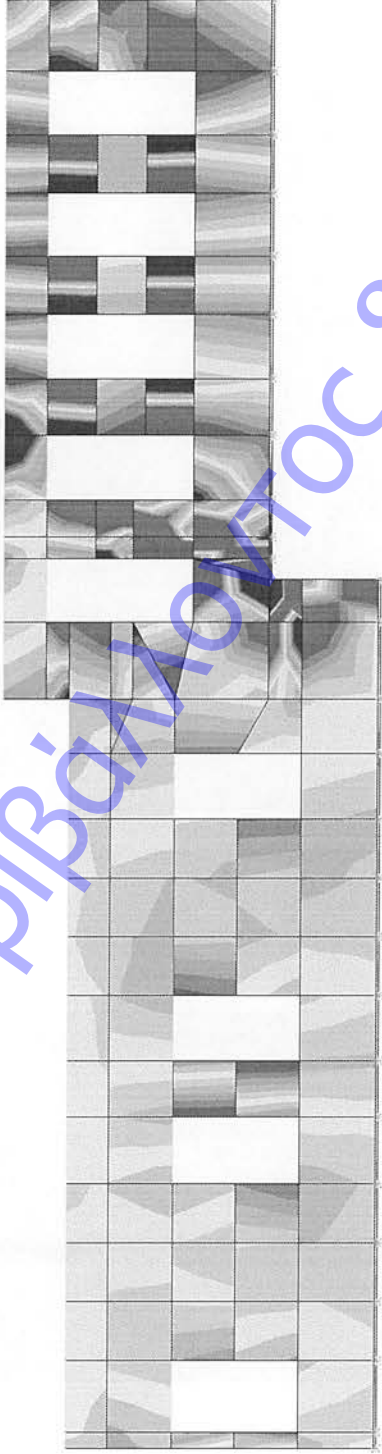

11 OPSI 135MON+150KN-S22

ΤΟ ΜΟΒ ΑΝΤΙΣΤΟΙΧΕΙ ΣΕ ΕΦΕΚΛΙΣΜΟ
+1000KN/m2
ΤΟ ΚΟΚΚΙΝΟ ΑΝΤΙΣΤΟΙΧΕΙ ΣΕ ΤΗΛΙΨΙ
-1000KN/m2.
MAX EPITREPOMENH THΛIPTIKH
TASH -7300KN/m2
Ο ΕΦΕΚΛΙΣΜΟΣ ΘΑ ΠΑΡΑΛΗΨΤΗΙ
ΑΠΟ ΤΟΝ ΤΟΡΟΤΗΤΟΥΜΕΝΟ
ΟΠΛΙΣΜΟ

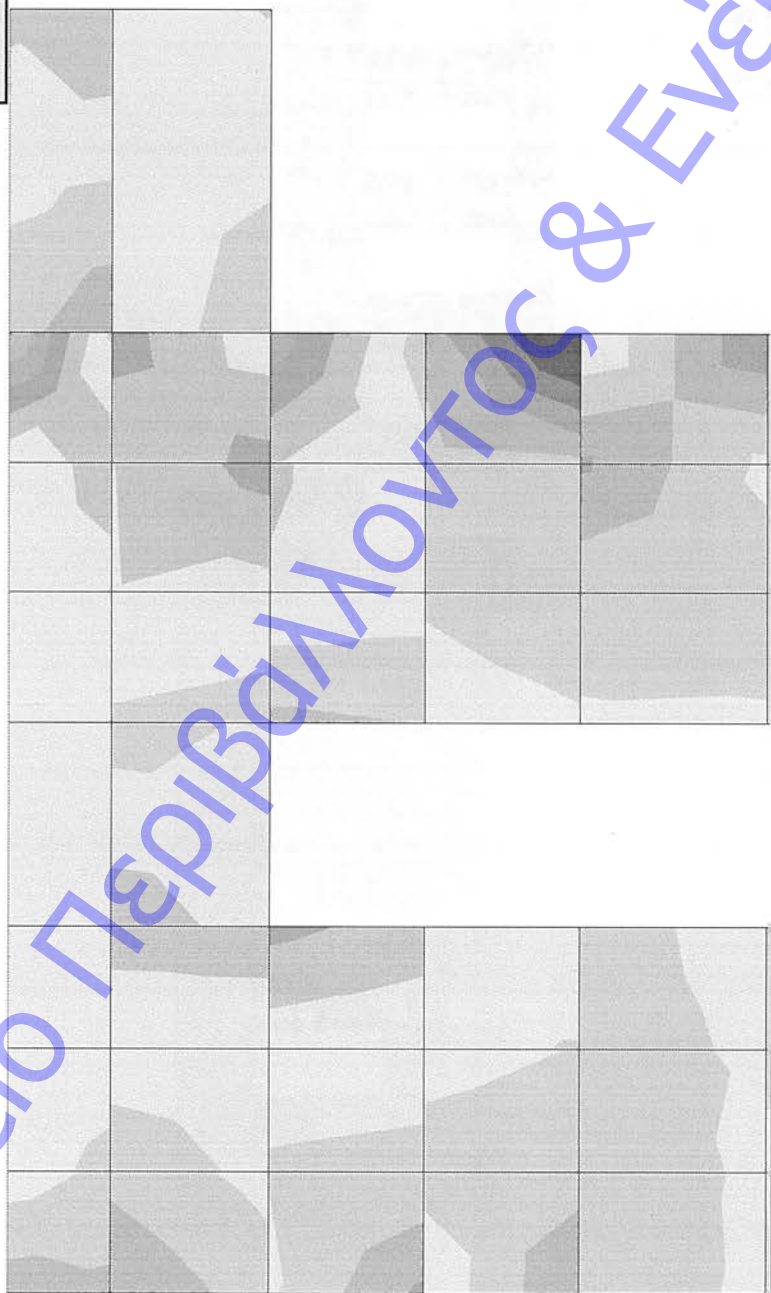

-1.00 -0.85 -0.69 -0.54 -0.38 -0.23 -0.08 0.08 0.23 0.38 0.54 0.69 0.85 1.00 E+3

11 OPSI SEISMOS Y+ S22

ΤΟ ΜΟΒ ΑΝΤΙΣΤΟΙΧΕΙ ΣΕ ΕΦΕΚΛΙΣΜΟ +1000KN/m2
ΤΟ ΚΟΚΚΙΝΟ ΑΝΤΙΣΤΟΙΧΕΙ ΣΕ ΤΗΛΙΨΙ -1000KN/m2.
ΜΑΧ ΕΠΙΤΡΕΠΟΜΕΝΗ ΤΗΛΙΨΤΙΚΗ ΤΑΣΗ -7300KN/m2
Ο ΕΦΕΚΛΙΣΜΟΣ ΘΑ ΠΑΡΑΛΗΨΤΗΙ ΑΠΟ ΤΟΝ ΤΟΡΟΤΗΤΟΥΜΕΝΟ ΟΠΛΙΣΜΟ

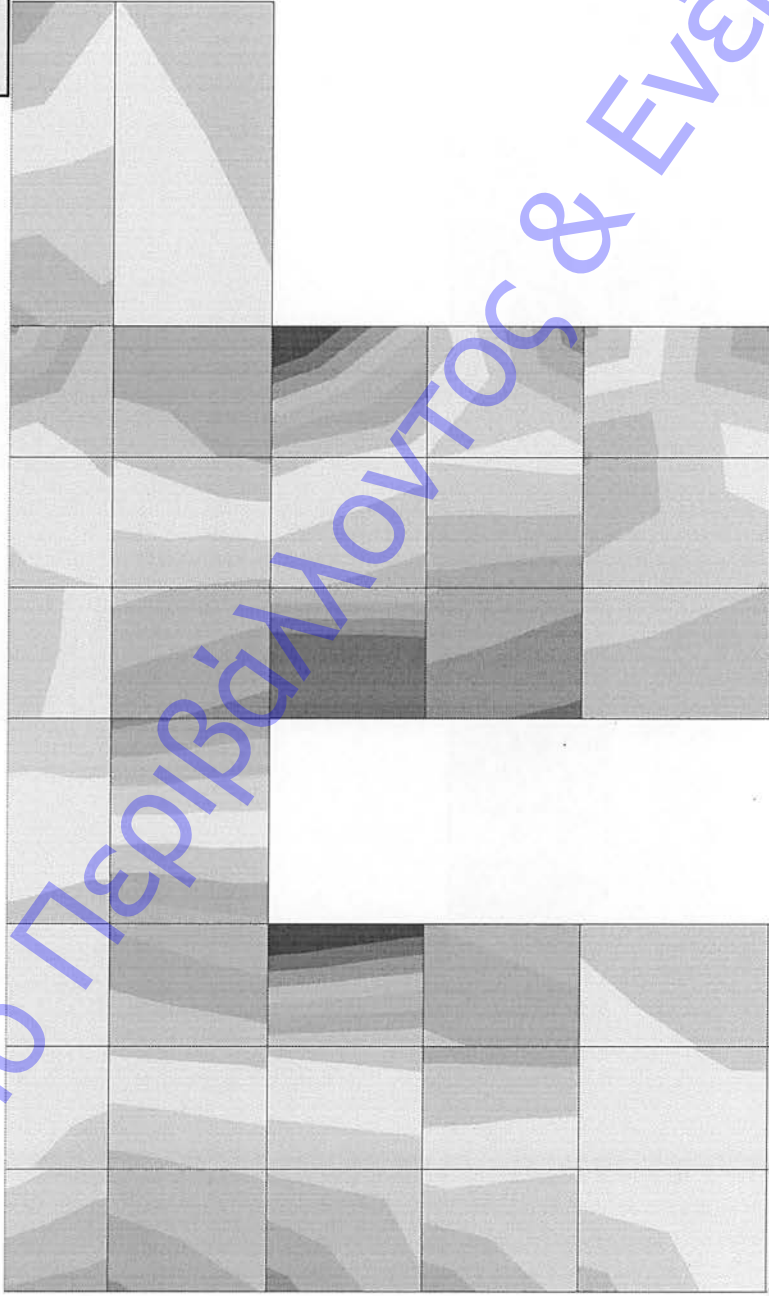



ETABS

11 OPSI SEISMOS Y- S22

ΤΟ ΜΟΒ ΑΝΤΙΣΤΟΙΧΕΙ ΣΕ ΕΦΕΚΛΙΣΜΟ
+1000KN/m²
ΤΟ ΚΟΚΚΙΝΟ ΑΝΤΙΣΤΟΙΧΕΙ ΣΕ ΤΗΛΙΨΙ
-1000KN/m².
MAX EPITREPOMENH THΛIPTIKH
TASH -7300KN/m²
O ΕΦΕΚΛΙΣΜΟΣ ΘΑ ΠΑΡΑΛΗΨΤΗΙ
ΑΠΟ ΤΟΝ ΤΟΡΟΤΗΤΟΥΜΕΝΟ
ΟΠΛΙΣΜΟ

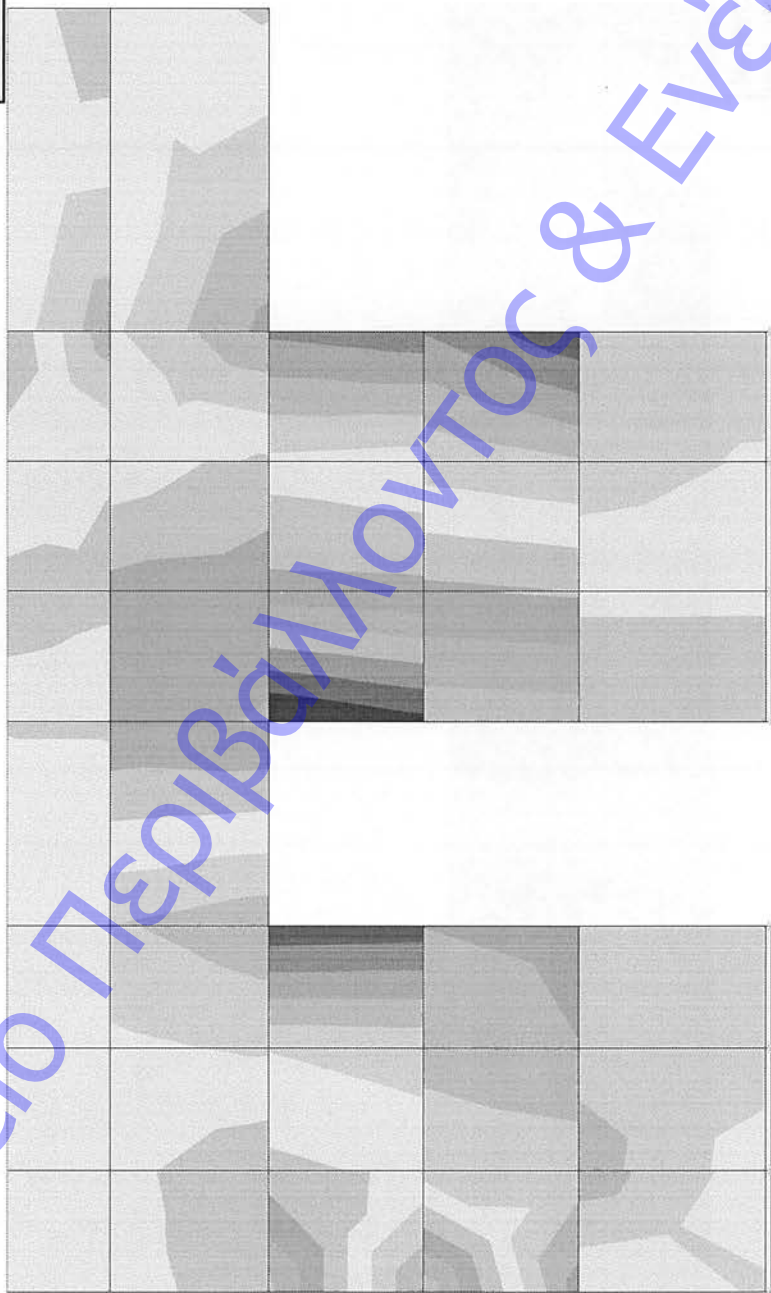



ΤΟ ΜΟΒ ΑΝΤΙΣΤΟΙΧΕΙ ΣΕ
ΕΦΕΚΛΙΣΜΟ +1000KN/m2
ΤΟ ΚΟΚΚΙΝΟ ΑΝΤΙΣΤΟΙΧΕΙ ΣΕ
ΤΗΛΙΨΙ -1000KN/m2.
ΜΑΧ ΕΠΙΤΡΕΠΟΜΕΝΗ ΤΗΛΙΨΤΙΚΗ
ΤΑΣΗ -7300KN/m2
Ο ΕΦΕΚΛΙΣΜΟΣ ΘΑ
ΠΑΡΑΛΗΨΕΤΑΙ ΑΠΟ ΤΟΝ
ΤΟΡΟΤΗΤΟΥΜΕΝΟ ΟΠΛΙΣΜΟ

13 OPSI 135MON+150KIN-S22

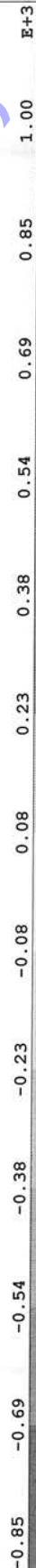
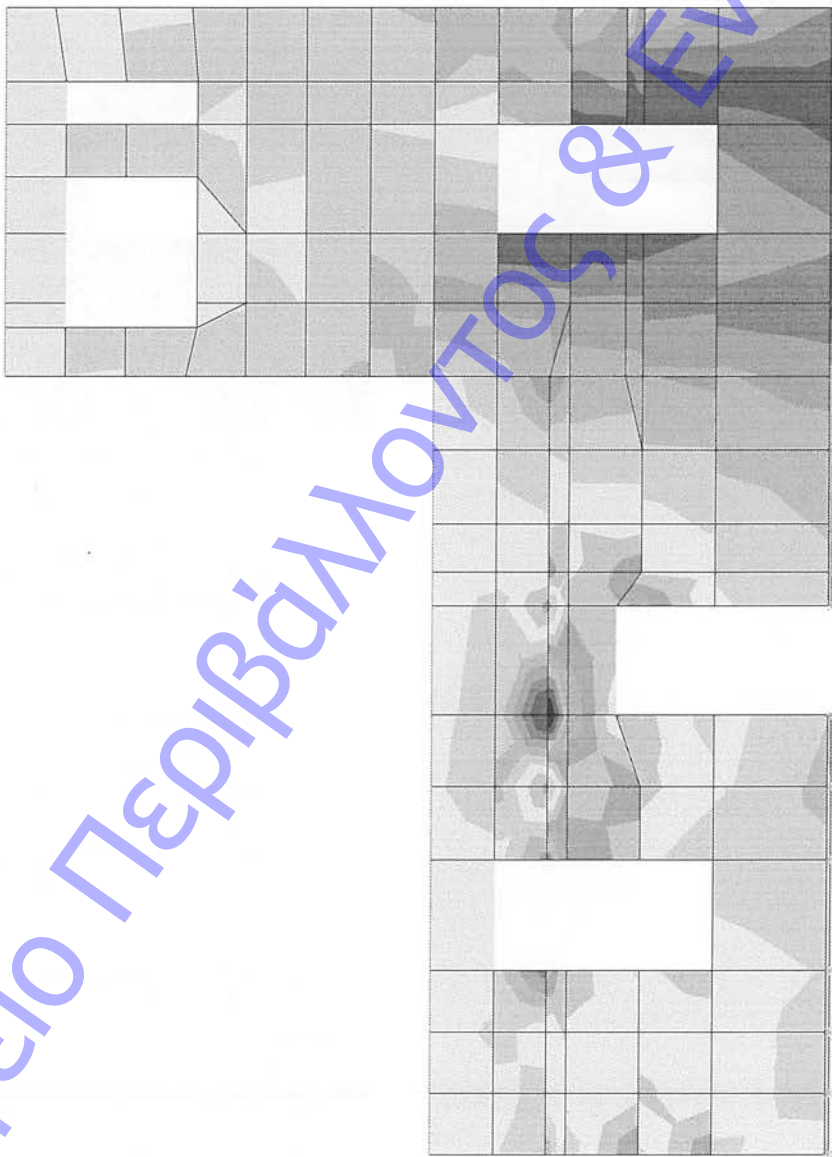

ETABS



13 OPSI SEISMOS Y+ S22

ΤΟ ΜΟΒ ΑΝΤΙΣΤΟΙΧΕΙ ΣΕ
ΕΦΕΚΛΙΣΜΟ +1000KN/m2
ΤΟ ΚΟΚΚΙΝΟ ΑΝΤΙΣΤΟΙΧΕΙ ΣΕ
ΤΗΛΙΨΙ -1000KN/m2.
ΜΑΧ ΕΠΙΤΡΕΠΟΜΕΝΗ ΤΗΛΙΡΤΙΚΗ
ΤΑΣΗ -7300KN/m2
Ο ΕΦΕΚΛΙΣΜΟΣ ΘΑ
ΠΑΡΑΛΗΦΤΗΙ ΑΠΟ ΤΟΝ
ΤΟΠΟΘΕΤΟΥΜΕΝΟ ΟΡΛΙΣΜΟ

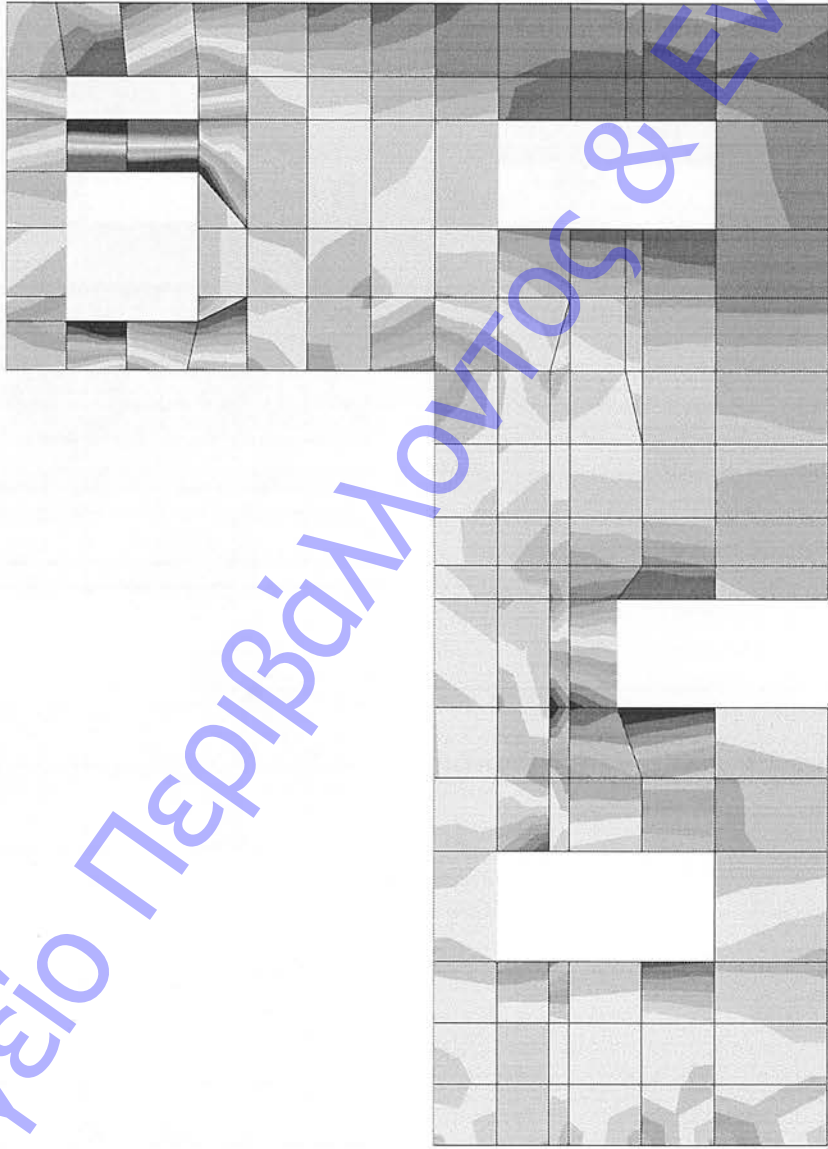

13 OPSI SEISMOS Y - S22

TO MOB ANTISTOIXEI SE
EFEKLISMO +1000KN/m2
TO KOKKINO ANTISTOIXEI SE
THLIPSI -1000KN/m2.
MAX EPITREPOMENH THLIPTIKH
TASH -7300KN/m2
O EFEKLISMOS THA
PARALHFTHEIAPO TON
TOPOTHETOYΜENO OPLISMO

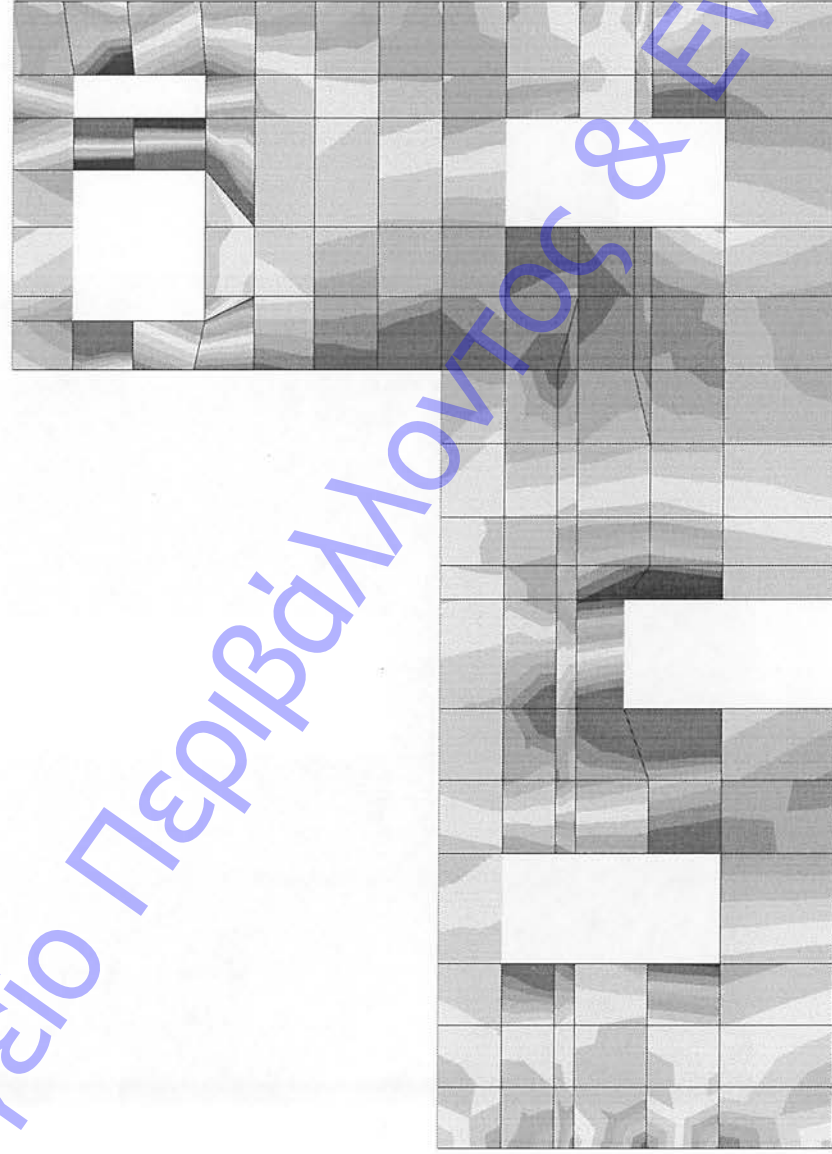

-0.85 -0.69 -0.54 -0.38 -0.23 -0.08 -0.08 0.08 0.23 0.38 0.54 0.69 0.85 1.00 E+3





ΤΟ ΜΟΒ ΑΝΤΙΣΤΟΙΧΕΙ ΣΕ ΕΦΕΚΛΙΣΜΟ
+1000KN/m2
ΤΟ ΚΟΚΚΙΝΟ ΑΝΤΙΣΤΟΙΧΕΙ ΣΕ ΤΗΛΙΨΙ
-1000KN/m2.
MAX ΕΠΙΤΡΕΠΟΜΕΝΗ ΤΗΛΙΨΤΙΚΗ
ΤΑΣΗ -7300KN/m2
Ο ΕΦΕΚΛΙΣΜΟΣ ΘΑ ΠΑΡΑΛΗΦΤΗΘΕΙ
ΑΠΟ ΤΟΝ ΤΟΡΟΤΗΤΟΥΜΕΝΟ
ΟΠΛΙΣΜΟ

15 OPSI 135MON+150KIN-S22





ΤΟ ΜΟΒ ΑΝΤΙΣΤΟΙΧΕΙ ΣΕ ΕΦΕΚΛΙΣΜΟ
+1000KN/m2
ΤΟ ΚΟΚΚΙΝΟ ΑΝΤΙΣΤΟΙΧΕΙ ΣΕ ΘΛΙΨΙ
-1000KN/m2.
ΜΑΧ ΕΠΙΤΡΕΠΟΜΕΝΗ ΘΛΙΨΤΙΚΗ
ΤΑΣΗ -7300KN/m2
Ο ΕΦΕΚΛΙΣΜΟΣ ΘΑ ΠΑΡΑΛΗΨΤΗΙ
ΑΠΟ ΤΟΝ ΤΟΡΟΘΗΤΟΥΜΕΝΟ
ΟΠΛΙΣΜΟ

15 OPSI SEISMOS Y+ S22

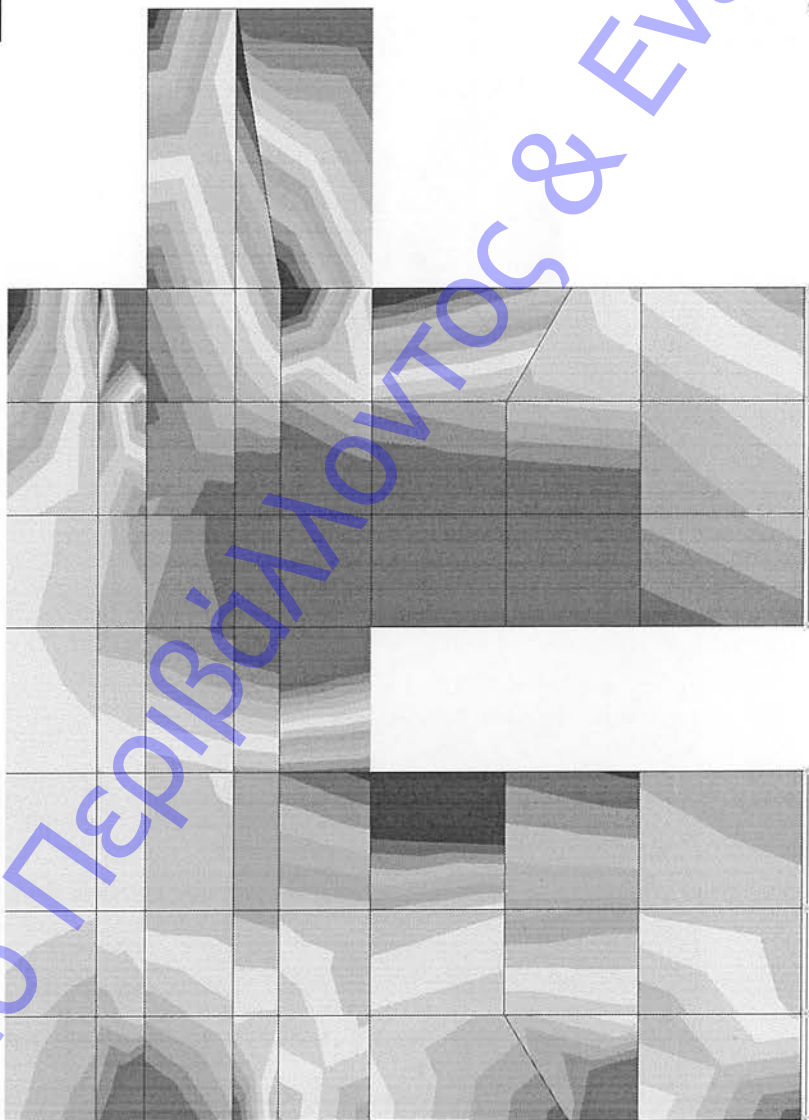

0.69 0.54 0.38 0.23 0.08 -0.08 -0.23 -0.38 -0.54 -0.69 -0.85 1.00 E+3



15 OPSI SEISMOS Y- S22

TO MOB ANTISTOIXEI SE EFEKLISMO
+1000KN/m2
TO KOKKINO ANTISTOIXEI SE THLIPSI
-1000KN/m2.
MAX EPITREPOMENH THLIPTIKH
TASH -7300KN/m2
O EFEKLISMOS THA PARALHFTHEI
APO TON TOROTHETOYMEHO
OPLISMO

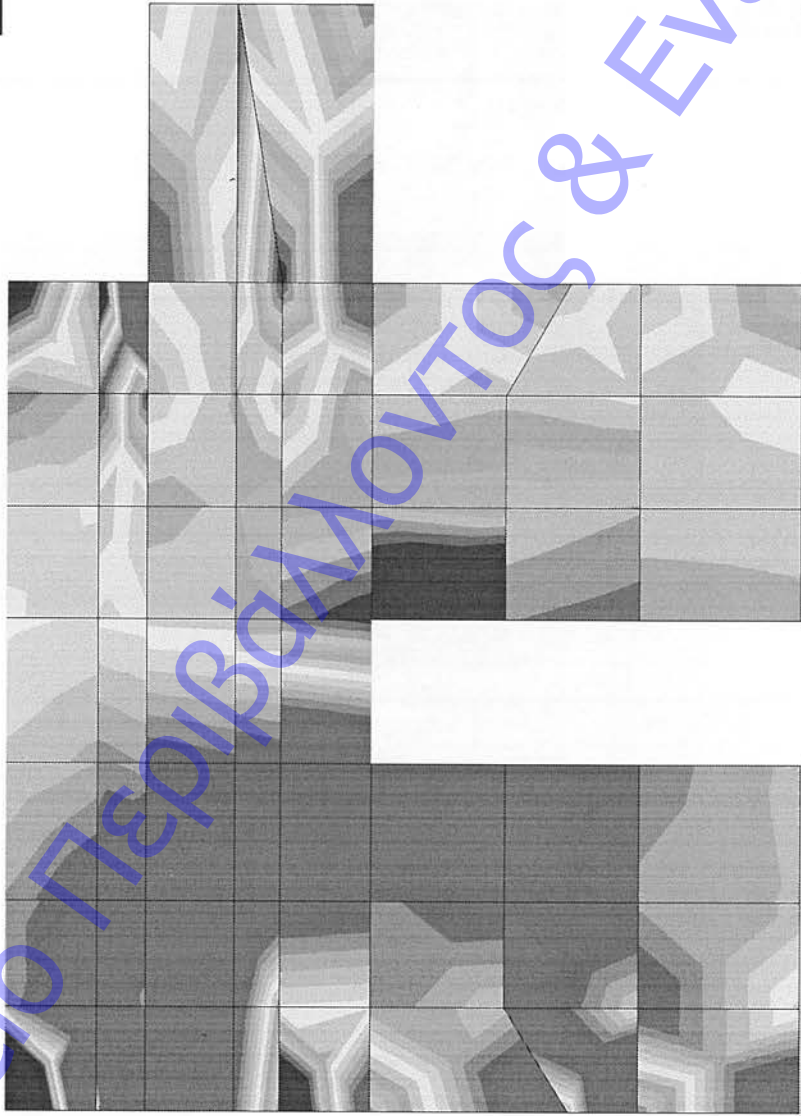

17 OPSI 135MON+150KIN-S22

ΤΟ ΜΟΒ ΑΝΤΙΣΤΟΙΧΕΙ ΣΕ ΕΦΕΚΛΙΣΜΟ
 +1000KN/m²
 ΤΟ ΚΟΚΚΙΝΟ ΑΝΤΙΣΤΟΙΧΕΙ ΣΕ ΤΗΛΙΨΙ
 -1000KN/m².
 ΜΑΧ ΕΠΙΤΡΕΠΟΜΕΝΗ ΤΗΛΙΨΤΙΚΗ
 ΤΑΣΗ -7300KN/m²
 Ο ΕΦΕΚΛΙΣΜΟΣ ΘΑ ΠΑΡΑΛΗΨΤΗΘΕΙ
 ΑΠΟ ΤΟΝ ΤΟΡΟΤΗΤΟΥΜΕΝΟ
 ΟΠΛΙΣΜΟ

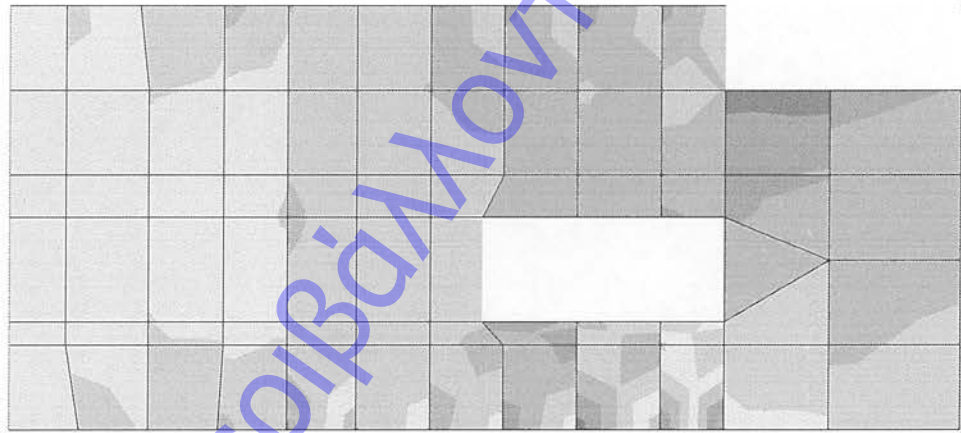

17 OPSI SEISMOS Y+ S22

TO MOB ANTISTOIXEI SE EFEKLISMO
 +1000KN/m2
 TO KOKKINO ANTISTOIXEI SE THLIPSI
 -1000KN/m2.
 MAX EPITREPOMENH THLIPTIKH
 TASH -7300KN/m2
 O EFEKLISMOS THA PARALHFTHEI
 APO TON TOPOTHETOYΜENO
 OPLISMO

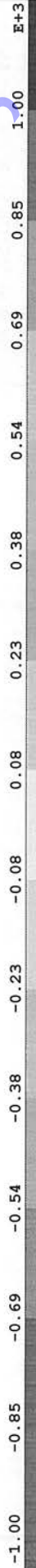
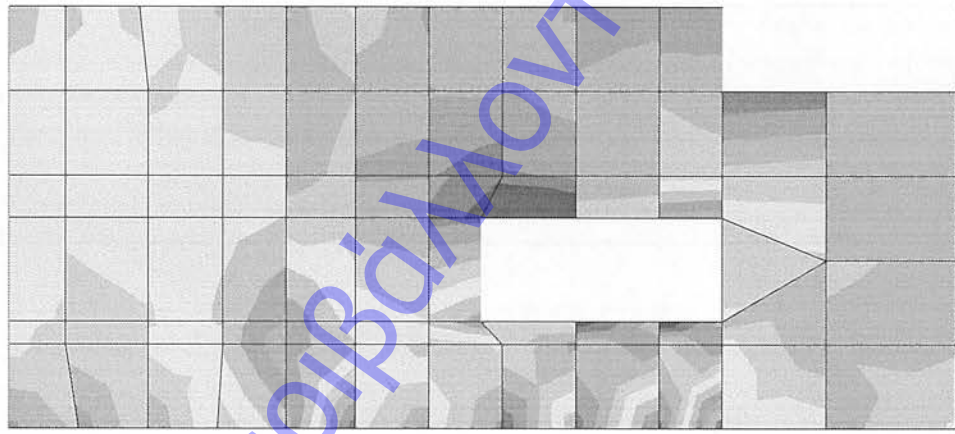

17 OPSI SEISMOS Y- S22

ΤΟ ΜΟΒ ΑΝΤΙΣΤΟΙΧΕΙ ΣΕ ΕΦΕΚΛΙΣΜΟ
 +1000KN/m2
 ΤΟ ΚΟΚΚΙΝΟ ΑΝΤΙΣΤΟΙΧΕΙ ΣΕ ΤΗΛΙΨΙ
 -1000KN/m2.
 ΜΑΧ ΕΠΙΤΡΕΠΟΜΕΝΗ ΤΗΛΙΨΤΙΚΗ
 ΤΑΣΗ -7300KN/m2
 Ο ΕΦΕΚΛΙΣΜΟΣ ΘΑ ΠΑΡΑΛΗΨΤΗΤΗΙ
 ΑΠΟ ΤΟΝ ΤΟΡΟΤΗΤΟΥΜΕΝΟ
 ΟΠΛΙΣΜΟ

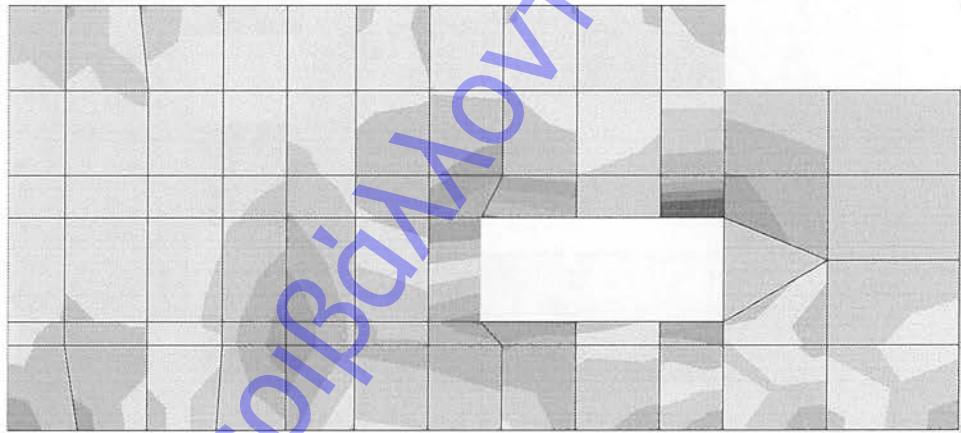

0.00 0.23 0.38 0.54 0.69 0.85 1.00 E+3



Υπουργείο Περιβάλλοντος & Ενέργειας

18 OPSI 135MON+150KIN-S22

ΤΟ ΜΟΒ ΑΝΤΙΣΤΟΙΧΕΙ ΣΕ ΕΦΕΚΛΙΣΜΟ
 +1000KN/m²
 ΤΟ ΚΟΚΚΙΝΟ ΑΝΤΙΣΤΟΙΧΕΙ ΣΕ ΘΛΙΨΙ
 -1000KN/m².
 ΜΑΧ ΕΠΙΤΡΕΡΟΜΕΝΗ ΘΛΙΨΤΙΚΗ
 ΤΑΣΗ -7300KN/m²
 Ο ΕΦΕΚΛΙΣΜΟΣ ΘΑ ΠΑΡΑΛΗΨΤΗΙ
 ΑΠΟ ΤΟΝ ΤΟΡΟΤΗΤΟΥΜΕΝΟ
 ΟΠΛΙΣΜΟ

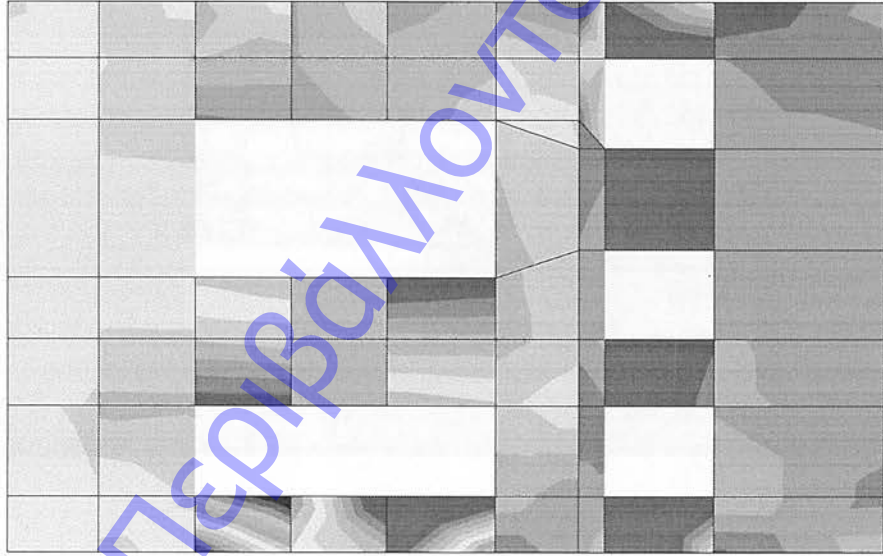

-1.00 -0.85 -0.69 -0.54 -0.38 -0.23 -0.08 0.08 0.23 0.38 0.54 0.69 0.85 1.00 E+3

18 OPSI SEISMOS Y+ S22

ΤΟ ΜΟΒ ΑΝΤΙΣΤΟΙΧΕΙ ΣΕ ΕΦΕΚΛΙΣΜΟ
+1000KN/m2
ΤΟ ΚΟΚΚΙΝΟ ΑΝΤΙΣΤΟΙΧΕΙ ΣΕ ΤΗΛΙΨΙ
-1000KN/m2.
ΜΑΧ ΕΠΙΤΡΕΠΟΜΕΝΗ ΤΗΛΙΨΤΙΚΗ
ΤΑΣΗ -7300KN/m2
Ο ΕΦΕΚΛΙΣΜΟΣ ΘΑ ΠΑΡΑΛΗΨΤΗΙ
ΑΠΟ ΤΟΝ ΤΟΡΟΤΗΤΟΥΜΕΝΟ
ΟΠΛΙΣΜΟ

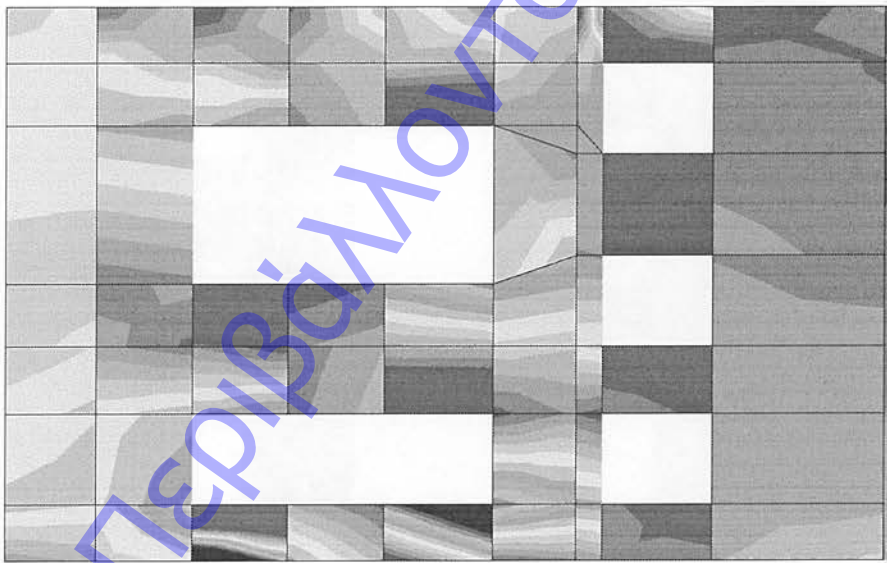

0.85 -0.69 -0.54 -0.38 0.08 0.23 0.38 0.54 0.69 0.85 1.00 E+3



18 OPSI SEISMOS Y- S22

ΤΟ ΜΟΒ ΑΝΤΙΣΤΟΙΧΕΙ ΣΕ ΕΦΕΚΛΙΣΜΟ
 +1000KN/m2
 ΤΟ ΚΟΚΚΙΝΟ ΑΝΤΙΣΤΟΙΧΕΙ ΣΕ ΤΗΛΙΨΙ
 -1000KN/m2.
 ΜΑΧ ΕΠΙΤΡΕΠΟΜΕΝΗ ΤΗΛΙΨΤΙΚΗ
 ΤΑΣΗ -7300KN/m2
 Ο ΕΦΕΚΛΙΣΜΟΣ ΘΑ ΠΑΡΑΛΗΦΤΗΙ
 ΑΠΟ ΤΟΝ ΤΟΡΟΤΗΤΟΥΜΕΝΟ
 ΟΠΛΙΣΜΟ

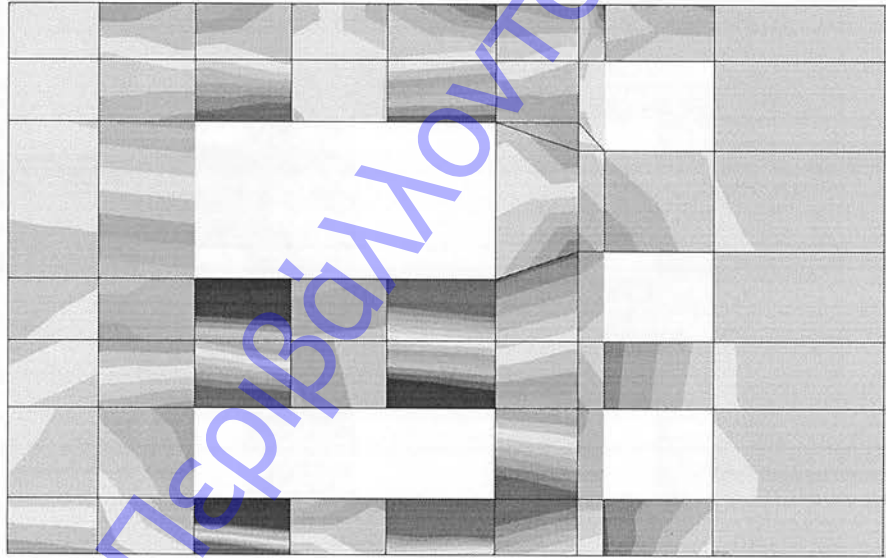

-1.00 -0.85 -0.69 -0.54 -0.38 -0.23 -0.08 -0.08 0.08 0.23 0.38 0.54 0.69 0.85 1.00 F+3

20 OPSI 135MON+150KIN-S22

ΤΟ ΜΟΒ ΑΝΤΙΣΤΟΙΧΕΙ ΣΕ ΕΦΕΚΛΙΣΜΟ
+1000KN/m2
ΤΟ ΚΟΚΚΙΝΟ ΑΝΤΙΣΤΟΙΧΕΙ ΣΕ ΤΗΛΙΨΙ
-1000KN/m2.
ΜΑΧ ΕΠΙΤΡΕΠΟΜΕΝΗ ΤΗΛΙΨΤΙΚΗ
ΤΑΣΗ -7300KN/m2
Ο ΕΦΕΚΛΙΣΜΟΣ ΘΑ ΠΑΡΑΛΗΨΤΗΤΗΙ
ΑΠΟ ΤΟΝ ΤΟΡΟΤΗΤΟΥΜΕΝΟ
ΟΠΛΙΣΜΟ

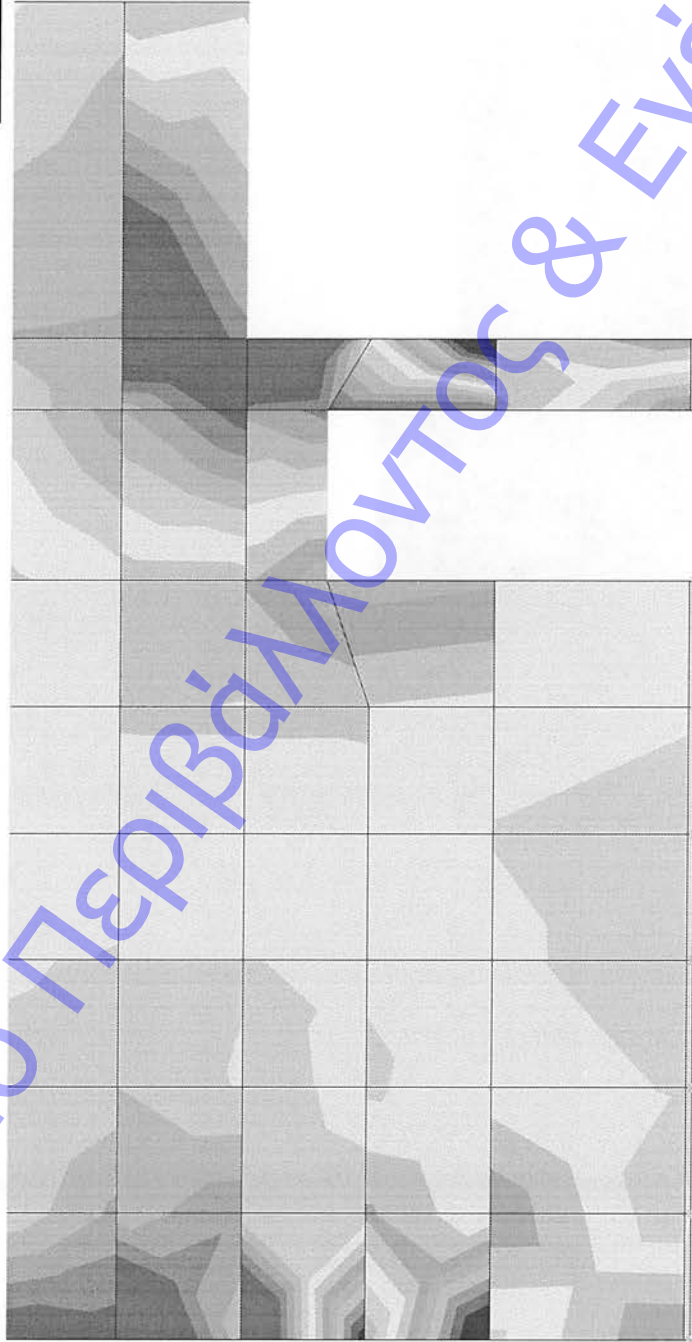

Υπουργείο Περιβάλλοντος & Ενέργειας





ETABS

20 OPSI SEISMOS Y+ S22

ΤΟ ΜΟΒ ΑΝΤΙΣΤΟΙΧΕΙ ΣΕ ΕΦΕΚΛΙΣΜΟ
+1000KN/m²
ΤΟ ΚΟΚΚΙΝΟ ΑΝΤΙΣΤΟΙΧΕΙ ΣΕ ΤΗΛΙΨΙ
-1000KN/m².
MAX EPITREPOMENH THΛIΠTIKH
TASH -7300KN/m²
Ο ΕΦΕΚΛΙΣΜΟΣ ΘΑ ΠΑΡΑΛΗΦΤΗΙ
ΑΠΟ ΤΟΝ ΤΟΡΟΤΗΤΟΥΜΕΝΟ
ΟΠΛΙΣΜΟ

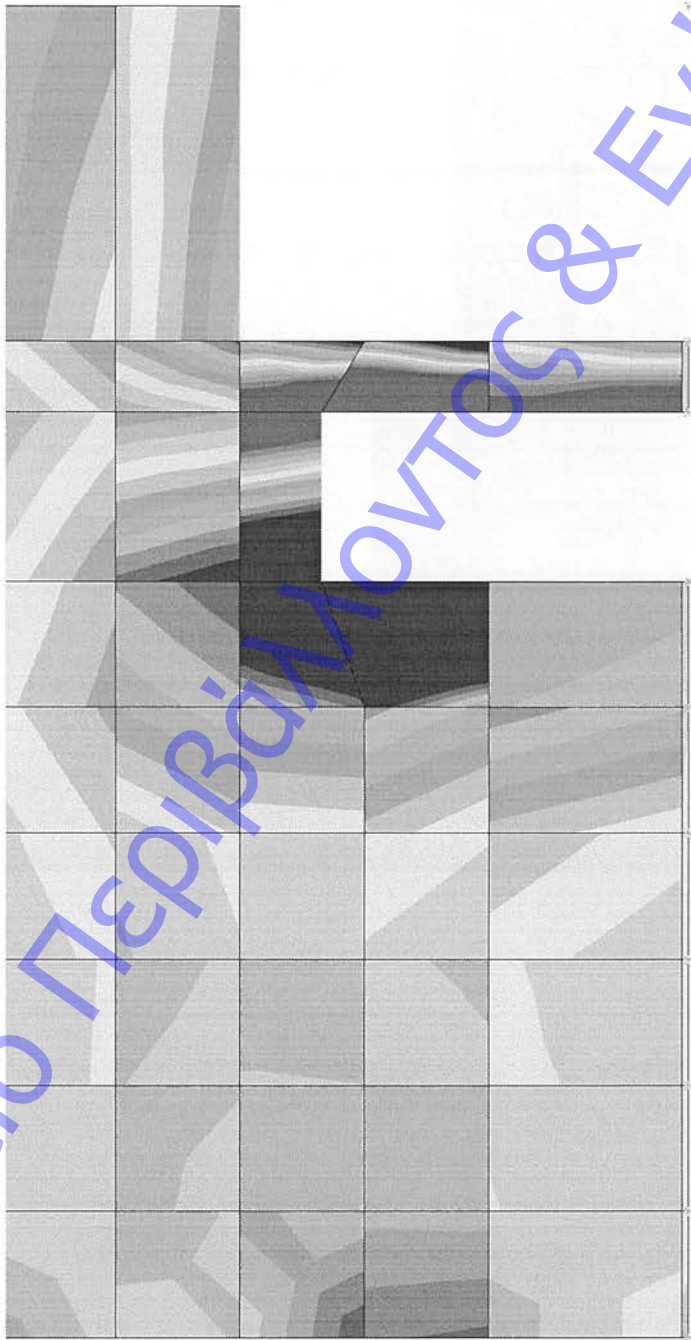

20 OPSI SEISMOS Y - S22

ΤΟ ΜΟΒ ΑΝΤΙΣΤΟΙΧΕΙ ΣΕ ΕΦΕΚΛΙΣΜΟ
+1000KN/m2
ΤΟ ΚΟΚΚΙΝΟ ΑΝΤΙΣΤΟΙΧΕΙ ΣΕ ΤΗΛΙΨΙ
-1000KN/m2.
ΜΑΧ ΕΠΙΤΡΕΠΟΜΕΝΗ ΤΗΛΙΨΤΙΚΗ
ΤΑΣΗ -7300KN/m2
Ο ΕΦΕΚΛΙΣΜΟΣ ΘΑ ΠΑΡΑΛΗΨΤΗΤΗΙ
ΑΠΟ ΤΟΝ ΤΟΡΟΤΗΤΟΥΜΕΝΟ
ΟΠΛΙΣΜΟ

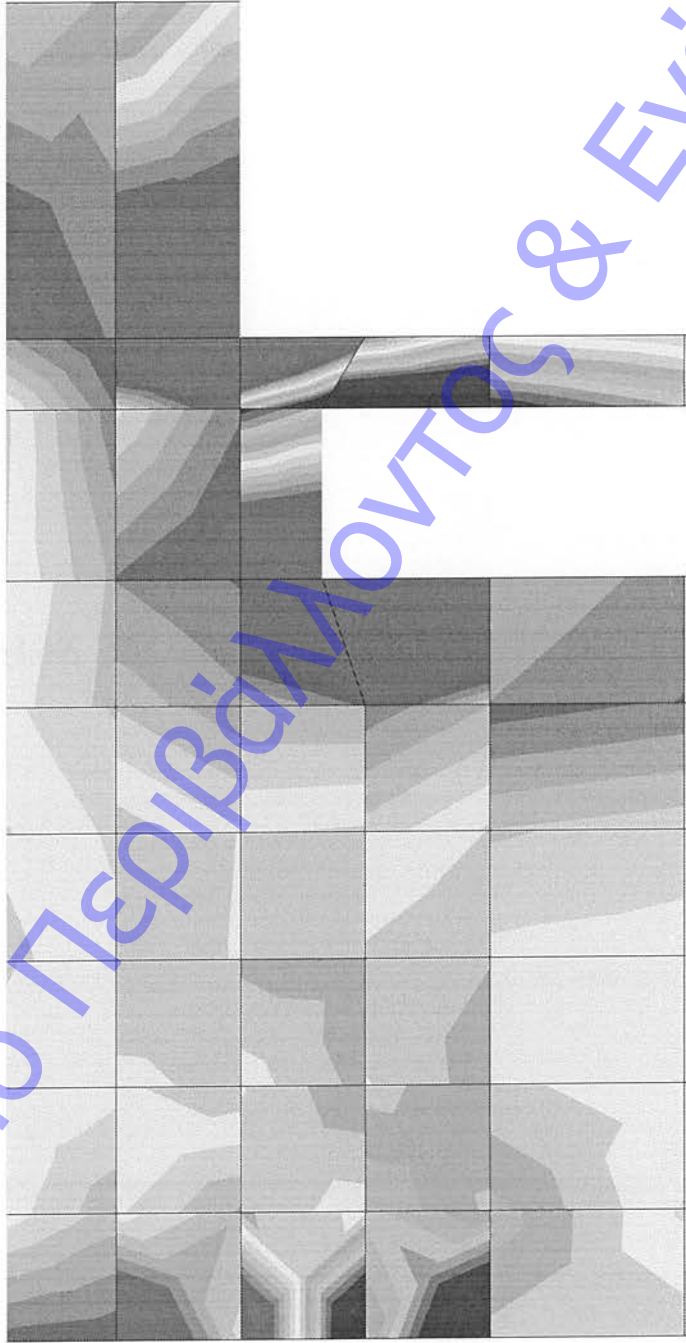

ΕΓΚΥΡΟ ΑΝΤΙΓΡΑΦΟ	Α/Α Πράξης: 423334
 0003543A7F908851CD669C51C48E7881	Ημ/νία έκδοσης πράξης: 07/06/2022 ΕΛΕΓΧΟΣ ΕΓΚΥΡΟΤΗΤΑΣ https://apps.tee.gr/adeiapublic/faces/searchDocFile

**ΑΠΟΤΕΛΕΣΜΑΤΑ ΑΝΑΛΥΣΗΣ ΜΕ ΔΕΙΚΤΗ
ΕΛΑΦΟΥΣ $K_v=20000 \text{ KN/m}^3$**

Υπουργείο Περιβάλλοντος & Ενέργειας

ΕΓΚΥΡΟ ΑΝΤΙΓΡΑΦΟ	Α/Α Πράξης: 423334
 0003543A7F908851CD669C51C48E7881	Ημ/νία έκδοσης πράξης: 07/06/2022 ΕΛΕΓΧΟΣ ΕΓΚΥΡΟΤΗΤΑΣ https://apps.tee.gr/adeiapublic/faces/searchDocFile

ΣΥΝΘΗΚΕΣ ΣΤΗΡΙΞΗΣ ($K_v=20000 \text{ KN/m}^3$)

Υπουργείο Περιβάλλοντος & Ενέργειας

ΤΜΗΜΑ_Β_ΤΕΥΧΟΣ_ΣΤΑΤΙΚΩΝ ΥΠΟΛΟΓΙΣΜΩΝ_ΠΡΟΤΑΣΗΣ ΕΝΙΣΧΥΣΗΣ





UNCOUPLED POINT SPRING ASSIGNMENTS

STORY	POINT	UX	UY	UZ	RX	RY	RZ
STORY1	51-3	0,0000	0,0000	20000,0000	0,0000	0,0000	0,0000
STORY1	76-14	0,0000	0,0000	20000,0000	0,0000	0,0000	0,0000
STORY1	79-14	0,0000	0,0000	20000,0000	0,0000	0,0000	0,0000
STORY1	71-14	0,0000	0,0000	15000,0000	0,0000	0,0000	0,0000
STORY1	70-14	0,0000	0,0000	15000,0000	0,0000	0,0000	0,0000
STORY1	68-14	0,0000	0,0000	20000,0000	0,0000	0,0000	0,0000
STORY1	67-14	0,0000	0,0000	16000,0000	0,0000	0,0000	0,0000
STORY1	81-13	0,0000	0,0000	29000,0000	0,0000	0,0000	0,0000
STORY1	82-14	0,0000	0,0000	10000,0000	0,0000	0,0000	0,0000
STORY1	69-14	0,0000	0,0000	15000,0000	0,0000	0,0000	0,0000
STORY1	72-14	0,0000	0,0000	15000,0000	0,0000	0,0000	0,0000
STORY1	89-7	0,0000	0,0000	0,0000	0,0000	0,0000	0,0000
STORY1	88-7	0,0000	0,0000	0,0000	0,0000	0,0000	0,0000
STORY1	87-7	0,0000	0,0000	18000,0000	0,0000	0,0000	0,0000
STORY1	96-6	0,0000	0,0000	2175,0000	0,0000	0,0000	0,0000
STORY1	77-16	0,0000	0,0000	15000,0000	0,0000	0,0000	0,0000
STORY1	78-16	0,0000	0,0000	34000,0000	0,0000	0,0000	0,0000
STORY1	75-10	0,0000	0,0000	20000,0000	0,0000	0,0000	0,0000
STORY1	73-14	0,0000	0,0000	20000,0000	0,0000	0,0000	0,0000
STORY1	66-14	0,0000	0,0000	20000,0000	0,0000	0,0000	0,0000
STORY1	89-10	0,0000	0,0000	6500,0000	0,0000	0,0000	0,0000
STORY1	88-10	0,0000	0,0000	13000,0000	0,0000	0,0000	0,0000
STORY1	87-10	0,0000	0,0000	18000,0000	0,0000	0,0000	0,0000
STORY1	97-5	0,0000	0,0000	18000,0000	0,0000	0,0000	0,0000
STORY1	95-7	0,0000	0,0000	6400,0000	0,0000	0,0000	0,0000
STORY1	96-7	0,0000	0,0000	12000,0000	0,0000	0,0000	0,0000
STORY1	100-7	0,0000	0,0000	14000,0000	0,0000	0,0000	0,0000
STORY1	110-7	0,0000	0,0000	5500,0000	0,0000	0,0000	0,0000
STORY1	109-7	0,0000	0,0000	27000,0000	0,0000	0,0000	0,0000
STORY1	108-7	0,0000	0,0000	24000,0000	0,0000	0,0000	0,0000
STORY1	107-7	0,0000	0,0000	24000,0000	0,0000	0,0000	0,0000
STORY1	106-7	0,0000	0,0000	24000,0000	0,0000	0,0000	0,0000
STORY1	105-7	0,0000	0,0000	24000,0000	0,0000	0,0000	0,0000
STORY1	104-7	0,0000	0,0000	24000,0000	0,0000	0,0000	0,0000
STORY1	103-7	0,0000	0,0000	24000,0000	0,0000	0,0000	0,0000
STORY1	102-7	0,0000	0,0000	20000,0000	0,0000	0,0000	0,0000
STORY1	101-7	0,0000	0,0000	14000,0000	0,0000	0,0000	0,0000
STORY1	111-8	0,0000	0,0000	25000,0000	0,0000	0,0000	0,0000
STORY1	127-8	0,0000	0,0000	25000,0000	0,0000	0,0000	0,0000
STORY1	112-8	0,0000	0,0000	21000,0000	0,0000	0,0000	0,0000
STORY1	113-7	0,0000	0,0000	21000,0000	0,0000	0,0000	0,0000
STORY1	128-7	0,0000	0,0000	21000,0000	0,0000	0,0000	0,0000
STORY1	129-7	0,0000	0,0000	21000,0000	0,0000	0,0000	0,0000
STORY1	130-8	0,0000	0,0000	21000,0000	0,0000	0,0000	0,0000
STORY1	114-8	0,0000	0,0000	21000,0000	0,0000	0,0000	0,0000
STORY1	126-7	0,0000	0,0000	21000,0000	0,0000	0,0000	0,0000
STORY1	125-7	0,0000	0,0000	24000,0000	0,0000	0,0000	0,0000
STORY1	124-7	0,0000	0,0000	26000,0000	0,0000	0,0000	0,0000
STORY1	123-7	0,0000	0,0000	24000,0000	0,0000	0,0000	0,0000
STORY1	122-7	0,0000	0,0000	24000,0000	0,0000	0,0000	0,0000
STORY1	121-7	0,0000	0,0000	24000,0000	0,0000	0,0000	0,0000
STORY1	120-7	0,0000	0,0000	24000,0000	0,0000	0,0000	0,0000
STORY1	119-7	0,0000	0,0000	24000,0000	0,0000	0,0000	0,0000
STORY1	118-7	0,0000	0,0000	24000,0000	0,0000	0,0000	0,0000
STORY1	117-7	0,0000	0,0000	20000,0000	0,0000	0,0000	0,0000
STORY1	116-7	0,0000	0,0000	7200,0000	0,0000	0,0000	0,0000
STORY1	131-7	0,0000	0,0000	14000,0000	0,0000	0,0000	0,0000
STORY1	132-8	0,0000	0,0000	20000,0000	0,0000	0,0000	0,0000
STORY1	133-8	0,0000	0,0000	15000,0000	0,0000	0,0000	0,0000
STORY1	134-8	0,0000	0,0000	10000,0000	0,0000	0,0000	0,0000
STORY1	135-8	0,0000	0,0000	18000,0000	0,0000	0,0000	0,0000
STORY1	136-8	0,0000	0,0000	18000,0000	0,0000	0,0000	0,0000
STORY1	137-8	0,0000	0,0000	25000,0000	0,0000	0,0000	0,0000
STORY1	138-8	0,0000	0,0000	25000,0000	0,0000	0,0000	0,0000
STORY1	139-8	0,0000	0,0000	18000,0000	0,0000	0,0000	0,0000
STORY1	140-8	0,0000	0,0000	10000,0000	0,0000	0,0000	0,0000
STORY1	141-8	0,0000	0,0000	4500,0000	0,0000	0,0000	0,0000
STORY1	142-5	0,0000	0,0000	18000,0000	0,0000	0,0000	0,0000
STORY1	143-5	0,0000	0,0000	20000,0000	0,0000	0,0000	0,0000
STORY1	145-4	0,0000	0,0000	22000,0000	0,0000	0,0000	0,0000
STORY1	146-5	0,0000	0,0000	18000,0000	0,0000	0,0000	0,0000
STORY1	147-5	0,0000	0,0000	18000,0000	0,0000	0,0000	0,0000
STORY1	148-5	0,0000	0,0000	12000,0000	0,0000	0,0000	0,0000
STORY1	149-5	0,0000	0,0000	2600,0000	0,0000	0,0000	0,0000
STORY1	150-5	0,0000	0,0000	15000,0000	0,0000	0,0000	0,0000
STORY1	151-4	0,0000	0,0000	5400,0000	0,0000	0,0000	0,0000
STORY1	152-5	0,0000	0,0000	15000,0000	0,0000	0,0000	0,0000
STORY1	153-5	0,0000	0,0000	18500,0000	0,0000	0,0000	0,0000
STORY1	156-7	0,0000	0,0000	20000,0000	0,0000	0,0000	0,0000
STORY1	157-7	0,0000	0,0000	20000,0000	0,0000	0,0000	0,0000
STORY1	158-7	0,0000	0,0000	20000,0000	0,0000	0,0000	0,0000
STORY1	159-7	0,0000	0,0000	20000,0000	0,0000	0,0000	0,0000
STORY1	160-7	0,0000	0,0000	20000,0000	0,0000	0,0000	0,0000
STORY1	161-7	0,0000	0,0000	10000,0000	0,0000	0,0000	0,0000
STORY1	162-7	0,0000	0,0000	5500,0000	0,0000	0,0000	0,0000
STORY1	163-4	0,0000	0,0000	20000,0000	0,0000	0,0000	0,0000
STORY1	164-3	0,0000	0,0000	20000,0000	0,0000	0,0000	0,0000

U N C O U P L E D P O I N T S P R I N G A S S I G N M E N T S

STORY	POINT	UX	UY	UZ	RX	RY	RZ
STORY1	166-4	0,0000	0,0000	20000,0000	0,0000	0,0000	0,0000
STORY1	168-4	0,0000	0,0000	10000,0000	0,0000	0,0000	0,0000
STORY1	173-14	0,0000	0,0000	22000,0000	0,0000	0,0000	0,0000
STORY1	174-14	0,0000	0,0000	12000,0000	0,0000	0,0000	0,0000
STORY1	169-14	0,0000	0,0000	15000,0000	0,0000	0,0000	0,0000
STORY1	170-12	0,0000	0,0000	15000,0000	0,0000	0,0000	0,0000
STORY1	83-13	0,0000	0,0000	17000,0000	0,0000	0,0000	0,0000
STORY1	171-12	0,0000	0,0000	22000,0000	0,0000	0,0000	0,0000
STORY1	172-12	0,0000	0,0000	11000,0000	0,0000	0,0000	0,0000
STORY1	176-5	0,0000	0,0000	20000,0000	0,0000	0,0000	0,0000
STORY1	177-5	0,0000	0,0000	20000,0000	0,0000	0,0000	0,0000
STORY1	178-5	0,0000	0,0000	20000,0000	0,0000	0,0000	0,0000
STORY1	179-5	0,0000	0,0000	17700,0000	0,0000	0,0000	0,0000
STORY1	180-5	0,0000	0,0000	7700,0000	0,0000	0,0000	0,0000
STORY1	182-5	0,0000	0,0000	17000,0000	0,0000	0,0000	0,0000
STORY1	181-5	0,0000	0,0000	7600,0000	0,0000	0,0000	0,0000
STORY1	183-5	0,0000	0,0000	22000,0000	0,0000	0,0000	0,0000
STORY1	186-5	0,0000	0,0000	23500,0000	0,0000	0,0000	0,0000
STORY1	187-5	0,0000	0,0000	15000,0000	0,0000	0,0000	0,0000
STORY1	190-5	0,0000	0,0000	14000,0000	0,0000	0,0000	0,0000
STORY1	192-5	0,0000	0,0000	17000,0000	0,0000	0,0000	0,0000
STORY1	191-5	0,0000	0,0000	17000,0000	0,0000	0,0000	0,0000
STORY1	193-5	0,0000	0,0000	14000,0000	0,0000	0,0000	0,0000
STORY1	195-5	0,0000	0,0000	14000,0000	0,0000	0,0000	0,0000
STORY1	194-5	0,0000	0,0000	14000,0000	0,0000	0,0000	0,0000
STORY1	198-5	0,0000	0,0000	20000,0000	0,0000	0,0000	0,0000
STORY1	199-5	0,0000	0,0000	23000,0000	0,0000	0,0000	0,0000
STORY1	200-5	0,0000	0,0000	20000,0000	0,0000	0,0000	0,0000
STORY1	201-5	0,0000	0,0000	15000,0000	0,0000	0,0000	0,0000
STORY1	241-2	0,0000	0,0000	3000,0000	0,0000	0,0000	0,0000
BASE	1	0,0000	0,0000	24000,0000	0,0000	0,0000	0,0000
BASE	2	0,0000	0,0000	3200,0000	0,0000	0,0000	0,0000
BASE	3	0,0000	0,0000	24000,0000	0,0000	0,0000	0,0000
BASE	4	0,0000	0,0000	24000,0000	0,0000	0,0000	0,0000
BASE	5	0,0000	0,0000	24000,0000	0,0000	0,0000	0,0000
BASE	6	0,0000	0,0000	24000,0000	0,0000	0,0000	0,0000
BASE	7	0,0000	0,0000	24000,0000	0,0000	0,0000	0,0000
BASE	8	0,0000	0,0000	24000,0000	0,0000	0,0000	0,0000
BASE	9	0,0000	0,0000	24000,0000	0,0000	0,0000	0,0000
BASE	10	0,0000	0,0000	24000,0000	0,0000	0,0000	0,0000
BASE	11	0,0000	0,0000	24000,0000	0,0000	0,0000	0,0000
BASE	12	0,0000	0,0000	24000,0000	0,0000	0,0000	0,0000
BASE	13	0,0000	0,0000	24000,0000	0,0000	0,0000	0,0000
BASE	14	0,0000	0,0000	24000,0000	0,0000	0,0000	0,0000
BASE	15	0,0000	0,0000	17000,0000	0,0000	0,0000	0,0000
BASE	16	0,0000	0,0000	13700,0000	0,0000	0,0000	0,0000
BASE	17	0,0000	0,0000	24000,0000	0,0000	0,0000	0,0000
BASE	18	0,0000	0,0000	16000,0000	0,0000	0,0000	0,0000
BASE	19	0,0000	0,0000	24000,0000	0,0000	0,0000	0,0000
BASE	20	0,0000	0,0000	24000,0000	0,0000	0,0000	0,0000
BASE	21	0,0000	0,0000	24000,0000	0,0000	0,0000	0,0000
BASE	22	0,0000	0,0000	24000,0000	0,0000	0,0000	0,0000
BASE	23	0,0000	0,0000	24000,0000	0,0000	0,0000	0,0000
BASE	24	0,0000	0,0000	24000,0000	0,0000	0,0000	0,0000
BASE	25	0,0000	0,0000	24000,0000	0,0000	0,0000	0,0000
BASE	26	0,0000	0,0000	24000,0000	0,0000	0,0000	0,0000
BASE	27	0,0000	0,0000	16000,0000	0,0000	0,0000	0,0000
BASE	28	0,0000	0,0000	24000,0000	0,0000	0,0000	0,0000
BASE	29	0,0000	0,0000	18000,0000	0,0000	0,0000	0,0000
BASE	30	0,0000	0,0000	21000,0000	0,0000	0,0000	0,0000
BASE	31	0,0000	0,0000	24000,0000	0,0000	0,0000	0,0000
BASE	32	0,0000	0,0000	24000,0000	0,0000	0,0000	0,0000
BASE	33	0,0000	0,0000	24000,0000	0,0000	0,0000	0,0000
BASE	34	0,0000	0,0000	24000,0000	0,0000	0,0000	0,0000
BASE	35	0,0000	0,0000	24000,0000	0,0000	0,0000	0,0000
BASE	36	0,0000	0,0000	24000,0000	0,0000	0,0000	0,0000
BASE	37	0,0000	0,0000	24000,0000	0,0000	0,0000	0,0000
BASE	38	0,0000	0,0000	24000,0000	0,0000	0,0000	0,0000
BASE	39	0,0000	0,0000	24000,0000	0,0000	0,0000	0,0000
BASE	40	0,0000	0,0000	24000,0000	0,0000	0,0000	0,0000
BASE	41	0,0000	0,0000	20000,0000	0,0000	0,0000	0,0000
BASE	42	0,0000	0,0000	32000,0000	0,0000	0,0000	0,0000
BASE	43	0,0000	0,0000	10000,0000	0,0000	0,0000	0,0000
BASE	44	0,0000	0,0000	10000,0000	0,0000	0,0000	0,0000
BASE	46	0,0000	0,0000	20000,0000	0,0000	0,0000	0,0000
BASE	47	0,0000	0,0000	20000,0000	0,0000	0,0000	0,0000
BASE	48	0,0000	0,0000	20000,0000	0,0000	0,0000	0,0000
BASE	49	0,0000	0,0000	20000,0000	0,0000	0,0000	0,0000
BASE	50	0,0000	0,0000	20000,0000	0,0000	0,0000	0,0000
BASE	51	0,0000	0,0000	20000,0000	0,0000	0,0000	0,0000
BASE	52	0,0000	0,0000	11000,0000	0,0000	0,0000	0,0000
BASE	53	0,0000	0,0000	11000,0000	0,0000	0,0000	0,0000
BASE	54	0,0000	0,0000	20000,0000	0,0000	0,0000	0,0000
BASE	55	0,0000	0,0000	20000,0000	0,0000	0,0000	0,0000
BASE	56	0,0000	0,0000	20000,0000	0,0000	0,0000	0,0000
BASE	57	0,0000	0,0000	10000,0000	0,0000	0,0000	0,0000
BASE	58	0,0000	0,0000	23000,0000	0,0000	0,0000	0,0000





0003543A7F908851CD669C51C48E7881

UNCOUPLED POINT SPRING ASSIGNMENTS

STORY	POINT	UX	UY	UZ	RX	RY	RZ
BASE	59	0,0000	0,0000	26000,0000	0,0000	0,0000	0,0000
BASE	60	0,0000	0,0000	23000,0000	0,0000	0,0000	0,0000
BASE	61	0,0000	0,0000	20000,0000	0,0000	0,0000	0,0000
BASE	62	0,0000	0,0000	20000,0000	0,0000	0,0000	0,0000
BASE	63	0,0000	0,0000	24000,0000	0,0000	0,0000	0,0000
BASE	64	0,0000	0,0000	26000,0000	0,0000	0,0000	0,0000
BASE	65	0,0000	0,0000	26000,0000	0,0000	0,0000	0,0000
BASE	98	0,0000	0,0000	24000,0000	0,0000	0,0000	0,0000
BASE	99	0,0000	0,0000	23500,0000	0,0000	0,0000	0,0000
BASE	115	0,0000	0,0000	23500,0000	0,0000	0,0000	0,0000

Υπουργείο Περιβάλλοντος & Ενέργειας

ΕΓΚΥΡΟ ΑΝΤΙΓΡΑΦΟ	Α/Α Πράξης: 423334
 0003543A7F90B851CD669C51C48E7881	Ημ/νία έκδοσης πράξης: 07/06/2022 ΕΛΕΓΧΟΣ ΕΓΚΥΡΟΤΗΤΑΣ https://apps.tee.gr/adeiapublic/faces/searchDocFile

**ΟΡΙΖΟΝΤΙΕΣ ΜΕΤΑΚΙΝΗΣΕΙΣ ΣΕ
ΧΑΡΑΚΤΗΡΙΣΤΙΚΕΣ ΘΕΣΕΙΣ**

Υπουργείο Περιβάλλοντος & Ενέργειας



Story	Point	Load	UX	UY	UZ	RX	RY	RZ
STORY5	78-5	DEAD	0	-0.0001	-0.0006	0.00002	-0.00001	0
STORY5	78-5	LIVE	0.0001	0	-0.0007	0	0	-0.00001
STORY5	78-5	EXSTAT	0.0057	0.0017	-0.0049	-0.00014	0.00045	-0.00015
STORY5	78-5	EYSTAT	0.0014	0.017	-0.0012	-0.00153	0.00011	-0.00067
STORY5	78-5	SELFWEIGHT	0.0011	0.0039	-0.0074	-0.00038	0.0001	0.00005
STORY3	2,-6	DEAD	0	-0.0001	-0.0003	-0.00001	0.00003	0.00001
STORY3	2,-6	LIVE	0	0	-0.0001	-0.00001	0.00002	0.00001
STORY3	2,-6	EXSTAT	0.0021	0	0.002	0.00001	0.00012	-0.00048
STORY3	2,-6	EYSTAT	0.0001	0.0042	-0.0024	-0.00045	-0.00019	0.00009
STORY3	2,-6	SELFWEIGHT	0.0001	-0.0006	-0.0044	0.00017	-0.00006	-0.00002
STORY3	29,-6	DEAD	0	-0.0001	-0.0004	0.00002	0.00001	0
STORY3	29,-6	LIVE	0.0001	0	-0.0002	0.00001	0.00001	0
STORY3	29,-6	EXSTAT	0.0014	0.0001	0.002	0	0.0002	-0.00018
STORY3	29,-6	EYSTAT	-0.0001	0.0043	0.0028	-0.00061	-0.00001	0.00073
STORY3	29,-6	SELFWEIGHT	-0.0003	-0.0006	-0.0055	0.00009	-0.00006	0
STORY3	112-4	DEAD	0	0	-0.0006	0.00001	-0.00002	0
STORY3	112-4	LIVE	0.0001	0.0001	-0.0006	-0.00001	0	0
STORY3	112-4	EXSTAT	0.0026	0.0008	-0.0025	-0.00018	0.00038	-0.0001
STORY3	112-4	EYSTAT	-0.0028	0.0071	0.0097	-0.00122	-0.00043	-0.00031
STORY3	112-4	SELFWEIGHT	0.0001	0.0018	-0.0038	-0.00035	-0.00002	-0.00005

Υπουργείο Περιβάλλοντος

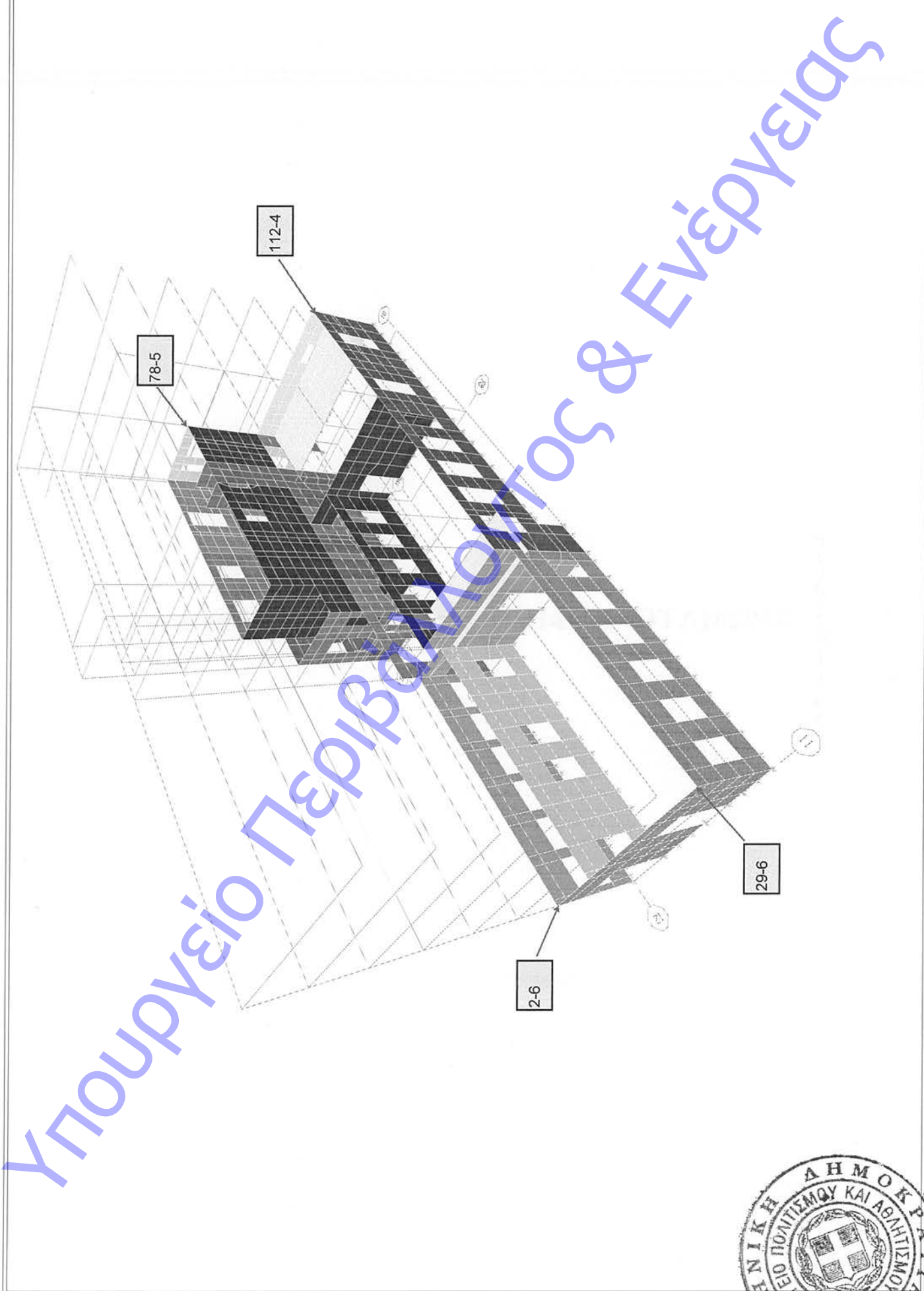

ΕΓΚΥΡΟ ΑΝΤΙΓΡΑΦΟ	Α/Α Πράξης: 423334
 0003543A7900851CD669C51C48E7881	Ημ/νία έκδοσης πράξης: 07/06/2022 ΕΛΕΓΧΟΣ ΕΓΚΥΡΟΤΗΤΑΣ https://apps.tee.gr/adeiapublic/faces/searchDocFile

ΧΡΩΜΑΤΟΓΡΑΦΙΚΗ ΑΠΕΙΚΟΝΙΣΗ ΤΑΣΕΩΝ

Υπουργείο Περιβάλλοντος & Ενέργειας

10 OPSI 135MON+150KIN-S22

TO MOB ANTISTOIXEI SE EFEKLISMO
 +1000KN/m2
 TO KOKKINO ANTISTOIXEI SE THLIPSI
 -1000KN/m2.
 MAX EPITREPOMENH THLIPTIKH
 TASH -7300KN/m2
 O EFEKLISMOS THA PARALHFTHEI
 APO TON TOPOTHETOYMENO
 OPLISMO

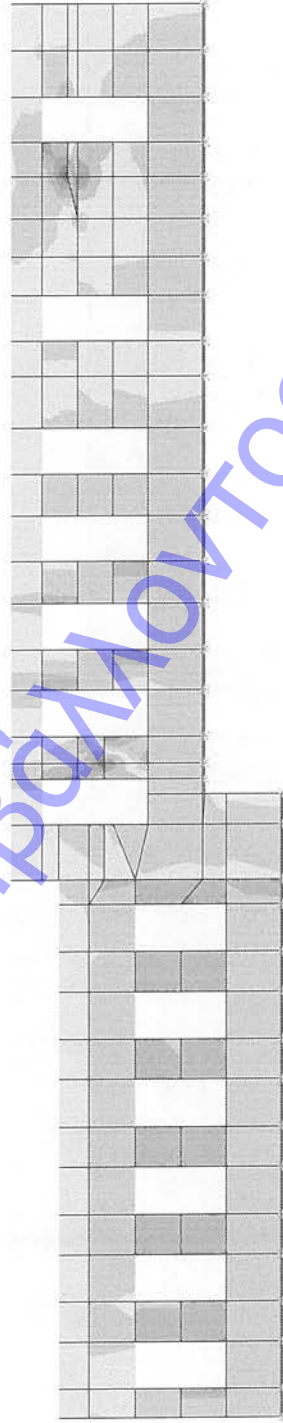



ETABS

10 OPSI SEISMOS X+ S22

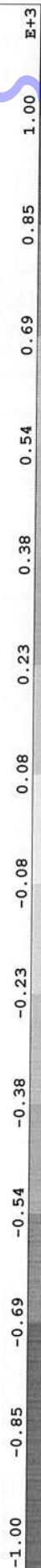
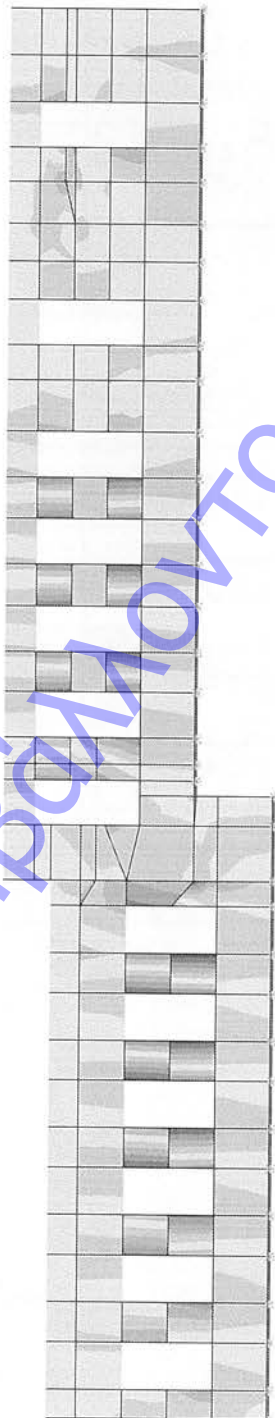



ETABS

10 OPSI SEISMOS X - S22

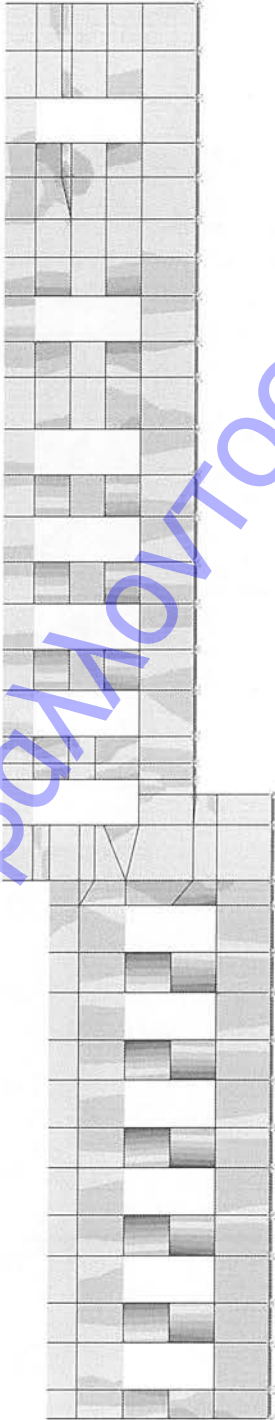

E+3 1.00 0.85 0.69 0.54 0.38 0.23 0.08 -0.08 -0.23 -0.38 -0.54 -0.69 -0.85





ETABS

12 OPSI 135MON+150KIN-S22

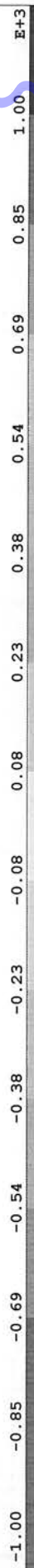
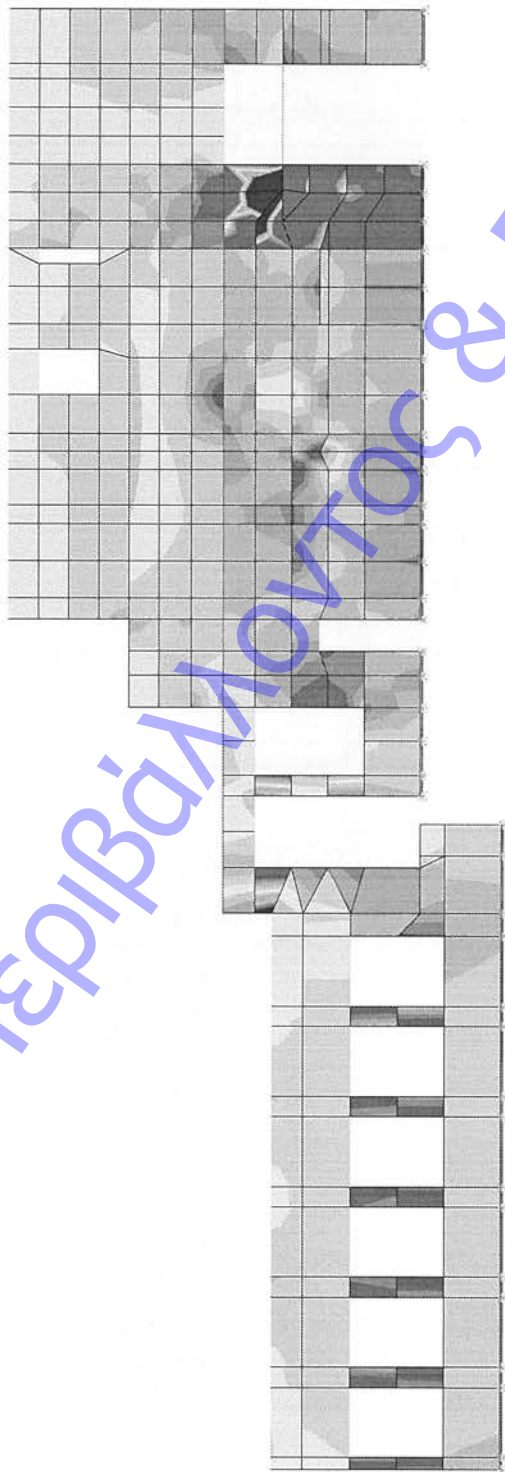



ETABS

12 OPSI SEISMOS X+ S22

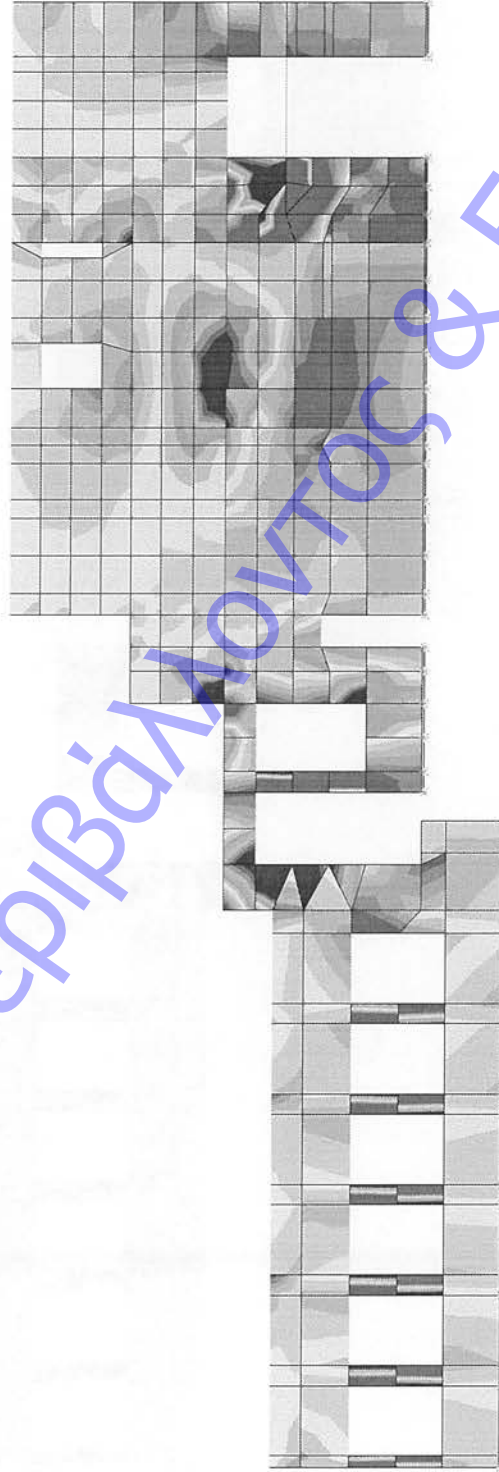

E+3

1.00

0.85

0.69

0.54

0.38

0.23

0.08

-0.08

-0.23

-0.38

-0.54

-0.69

-0.85





ETABS

12 OPSI SEISMOS X - S22

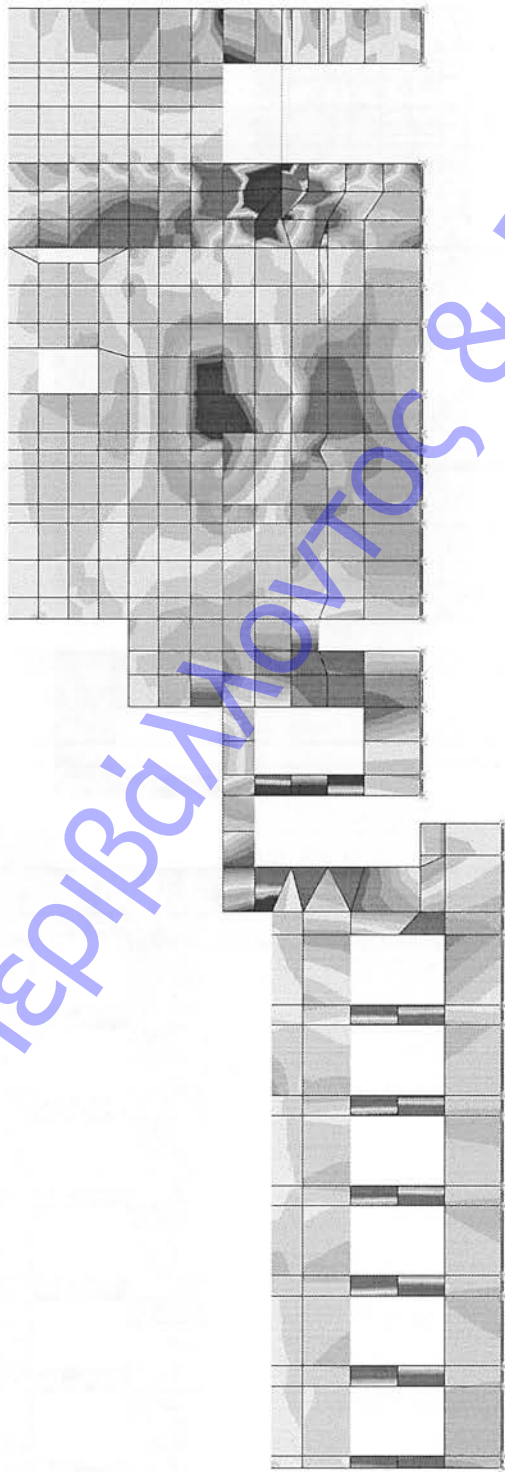



ETABS

19 OPSI 135MON+150KIN-S22

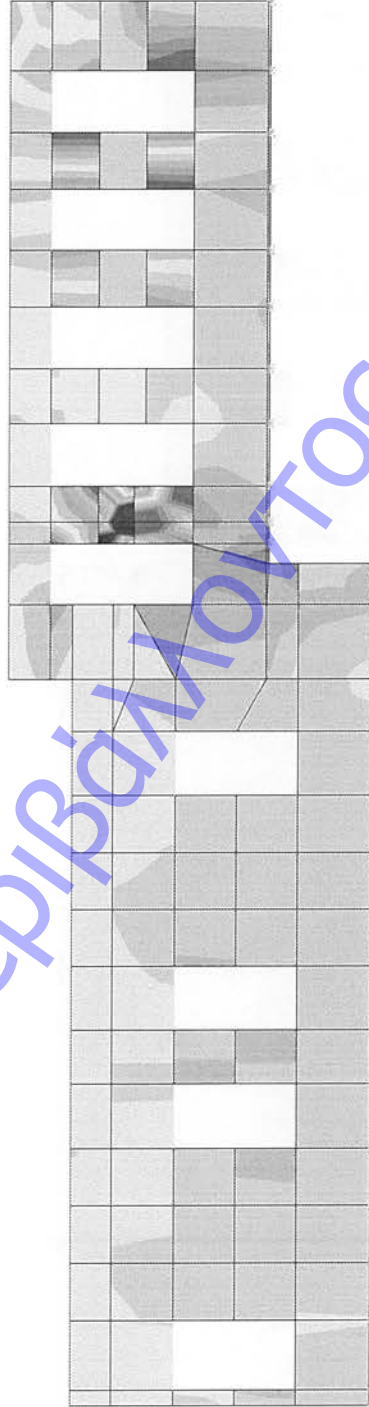



0003543A7F908851CD669C51C48E7881

ETABS

19 OPSI SEISMOS X+ S22

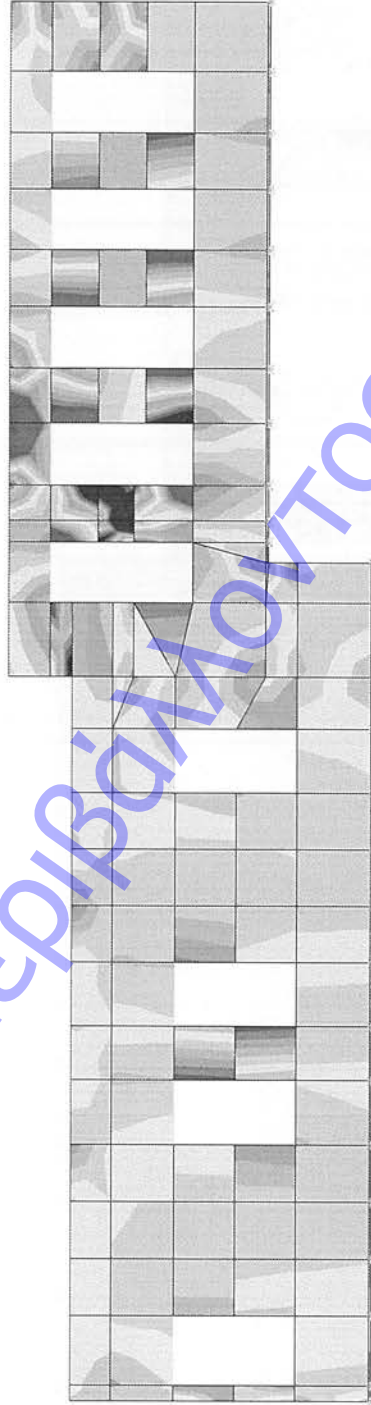



ETABS

19 OPSI SEISMOS X- S22

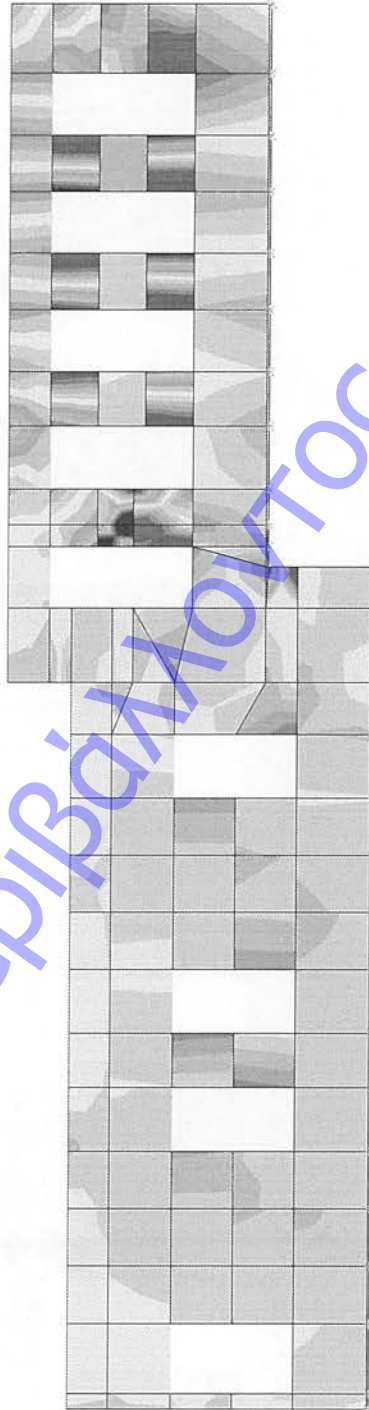

1.00 0.85 0.69 0.54 0.38 0.23 0.08 -0.08 -0.23 -0.38 -0.54 -0.69 -0.85 E+3





ETABS

16 OPSI 135MON+150KIN-S22

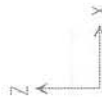
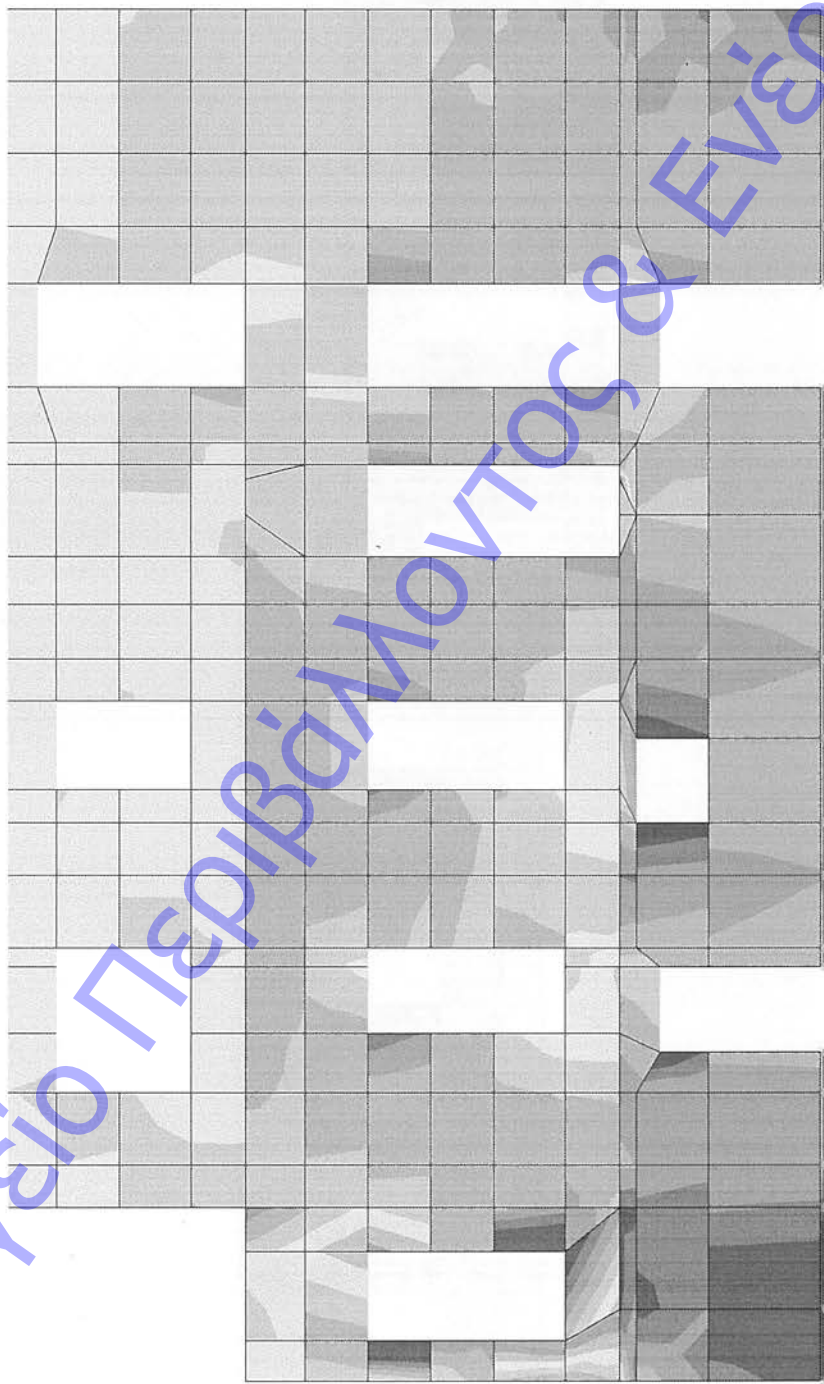

ETABS

16 OPSI SEISMOS X+ S22

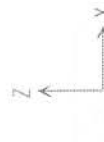
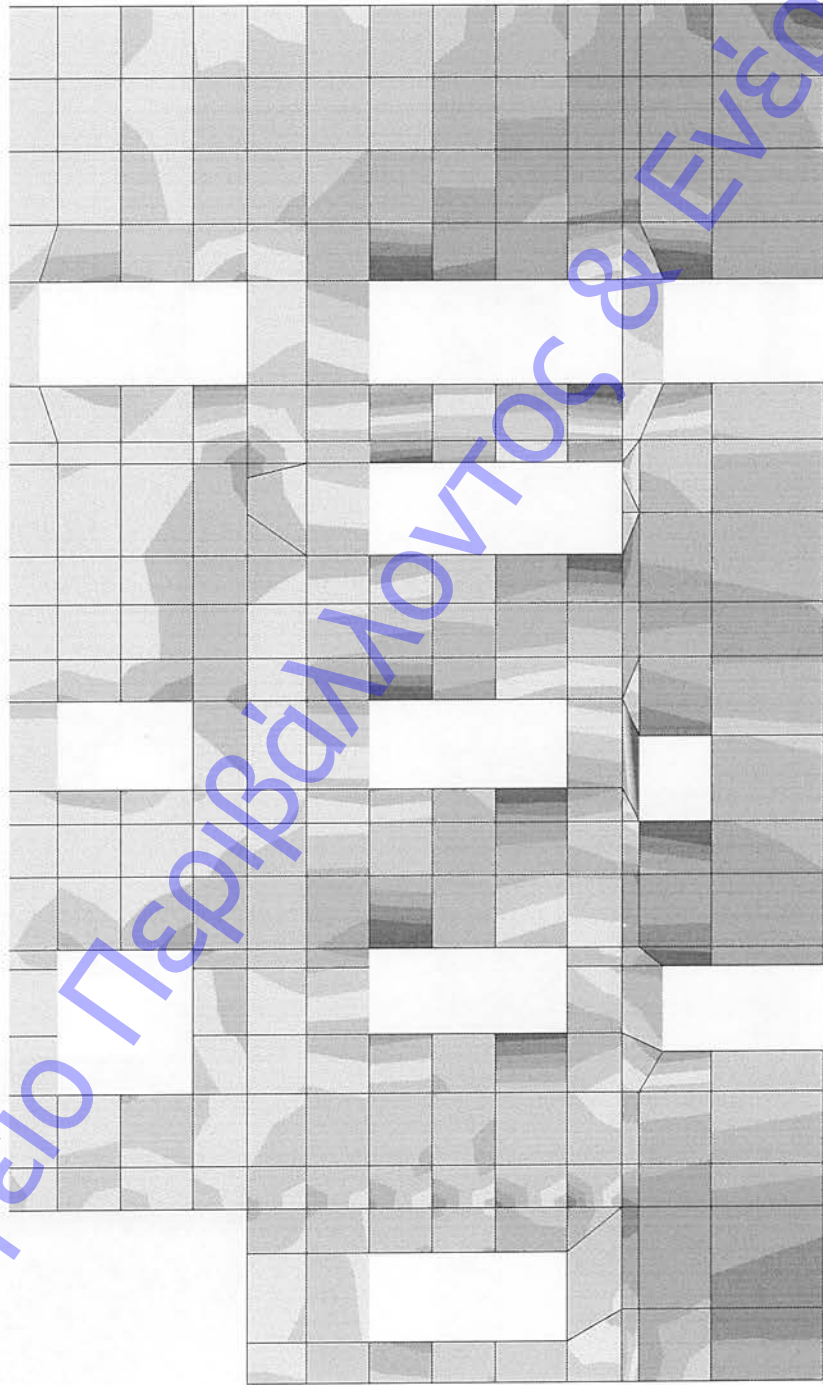

-0.85 -0.69 -0.54 -0.38 -0.23 -0.08 0.08 0.23 0.38 0.54 0.69 0.85 1.00 E+3





ETABS

16 OPSI SEISMOS X- S22

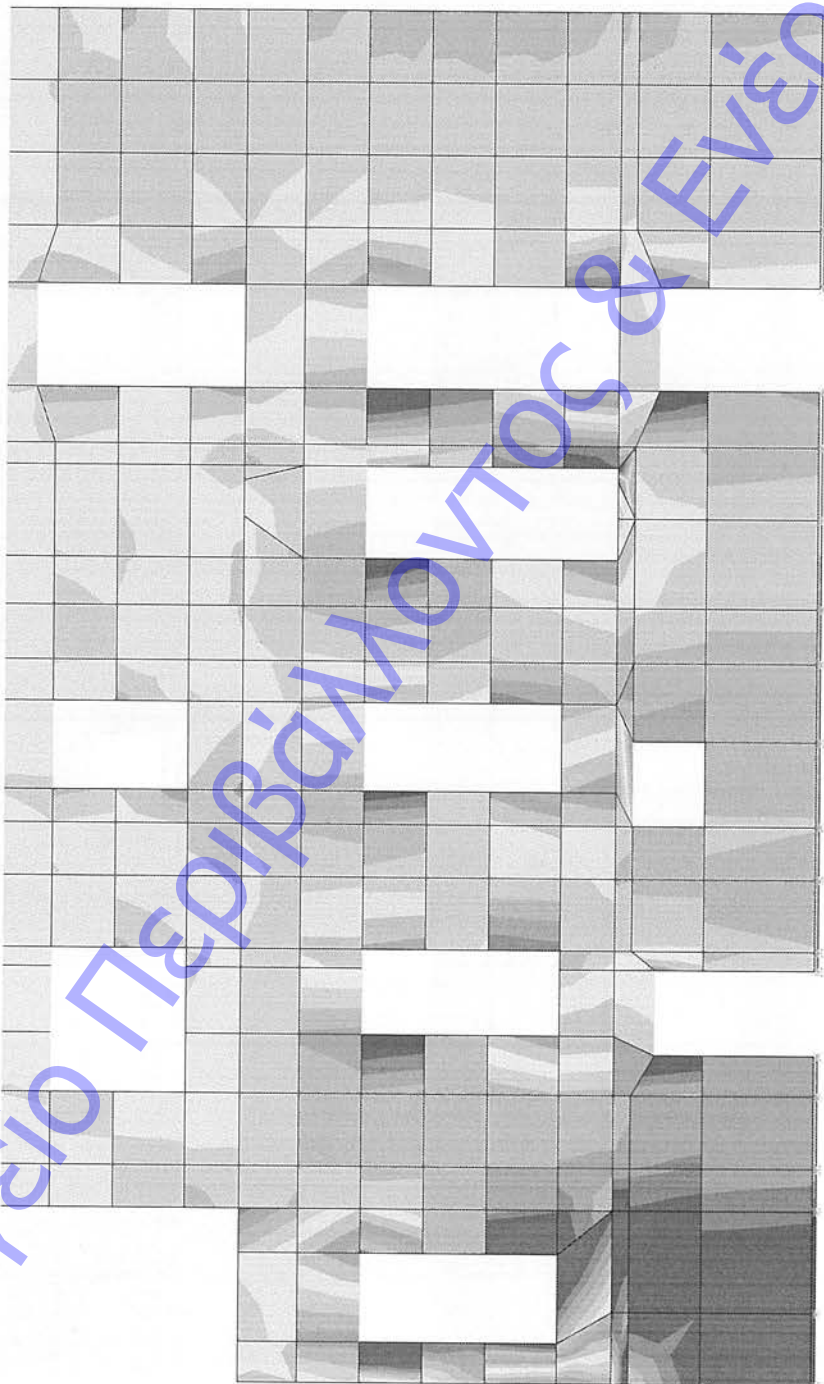



ETABS

11 OPSI 135MON+150KIN-S22

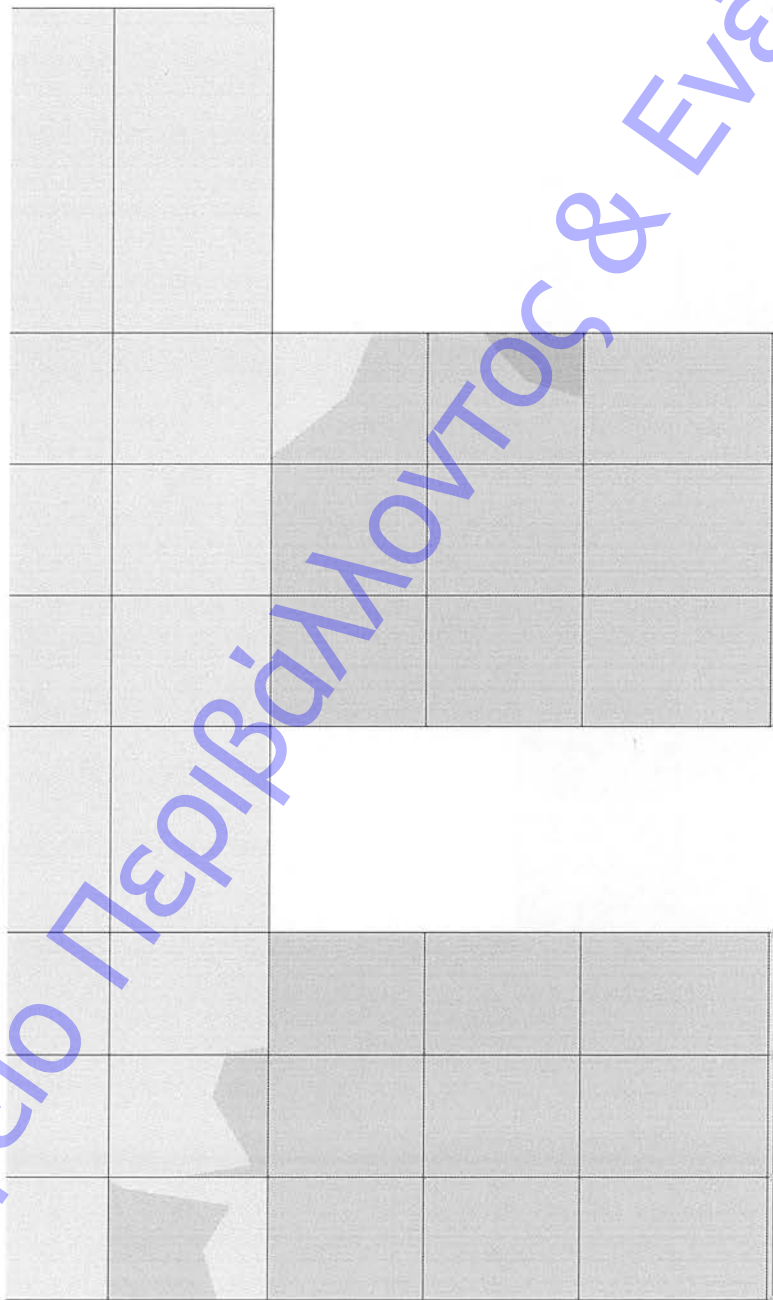



0003543A7F90B851CD669C51C48E7881

ETABS

11 OPSI SEISMOS Y+ S22

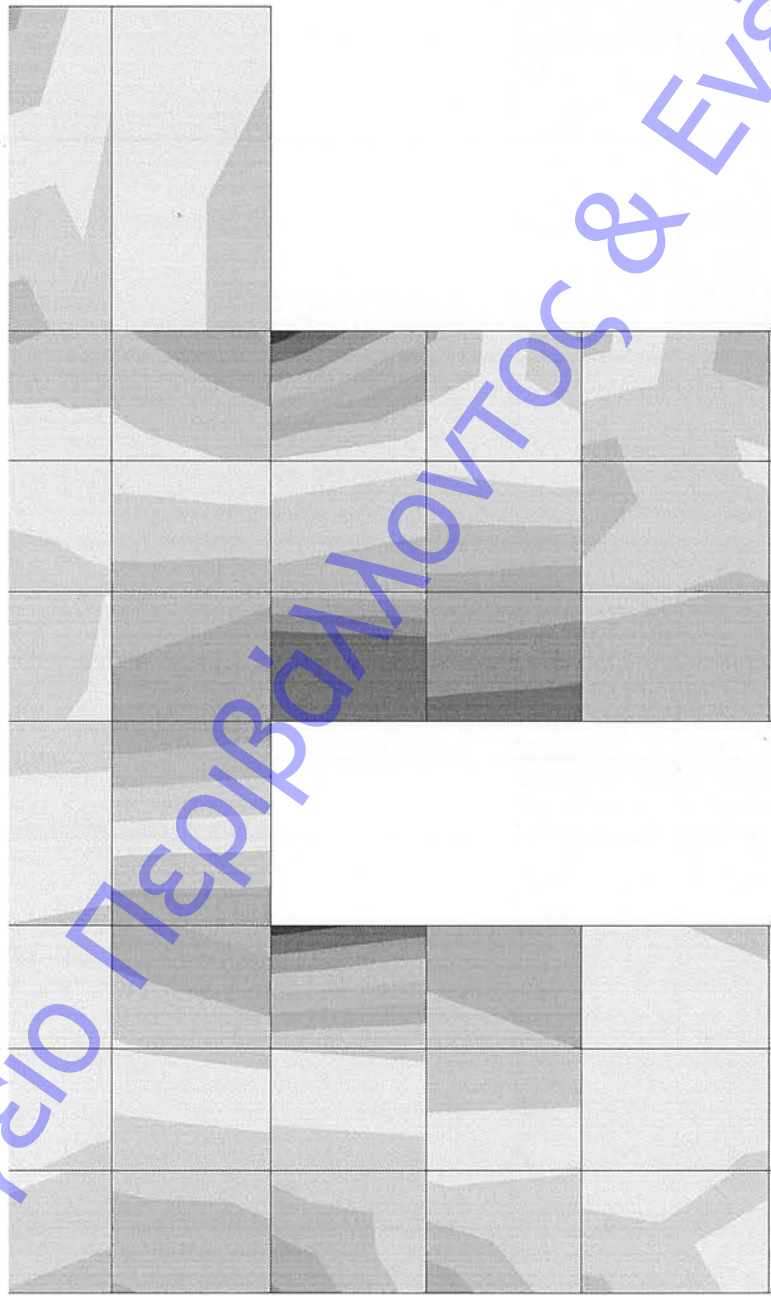



0003543A7F90B851CD669C51C48E7881

ETABS

11 OPSI SEISMOS Y - S22

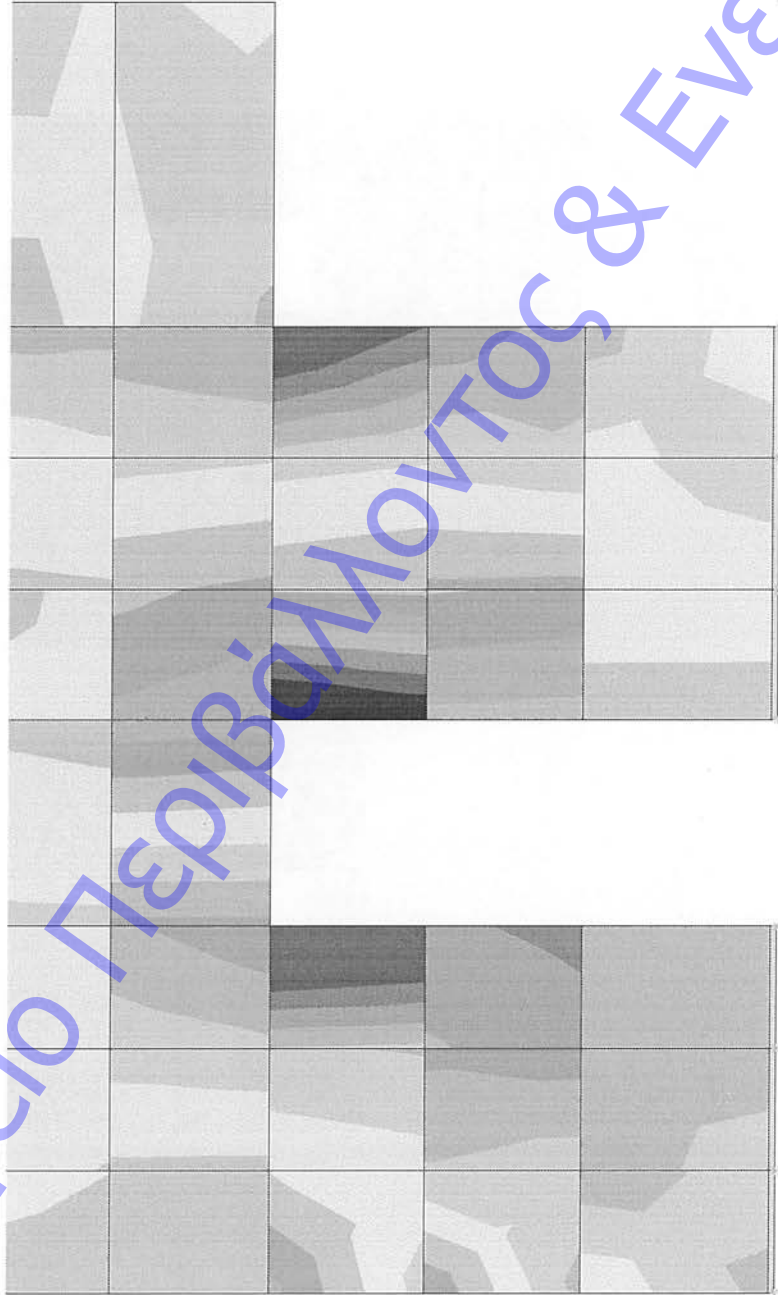

1.00 0.85 0.69 0.54 0.38 0.23 -0.08 -0.23 -0.38 -0.54 -0.69 -0.85 E+3



13 OPSI 135MON+150KIN-S22

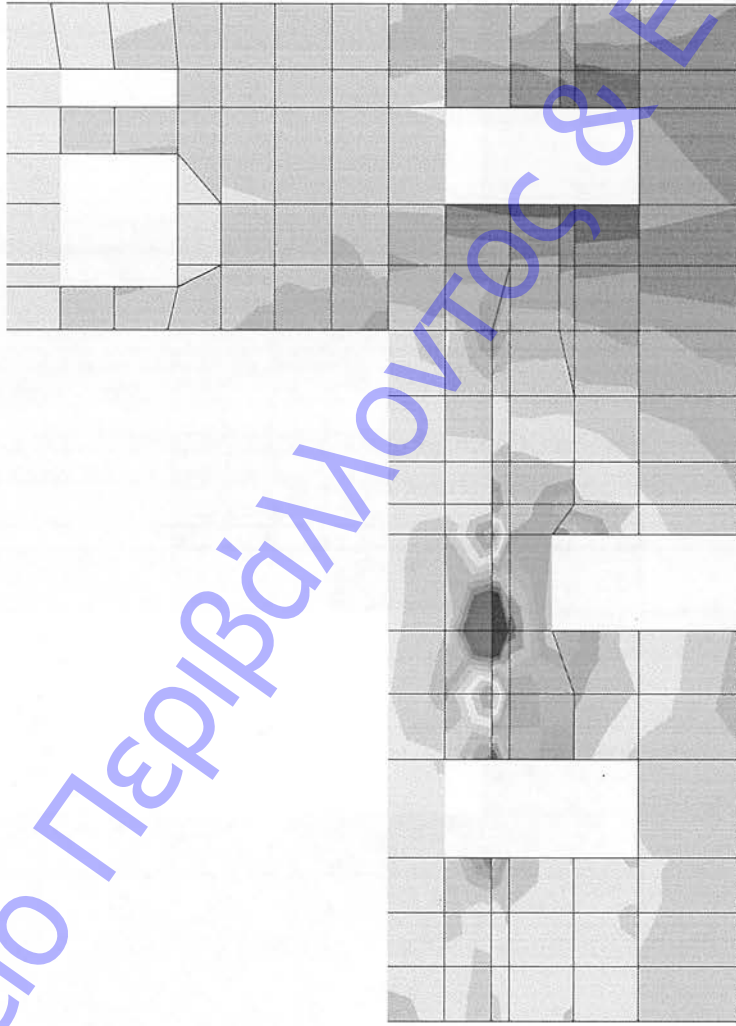

-1.00 -0.85 -0.69 -0.54 -0.38 -0.23 -0.08 -0.08 0.08 0.23 0.38 0.54 0.69 0.85 1.00 E+3



ETABS

13 OPSI SEISMOS Y+ S22

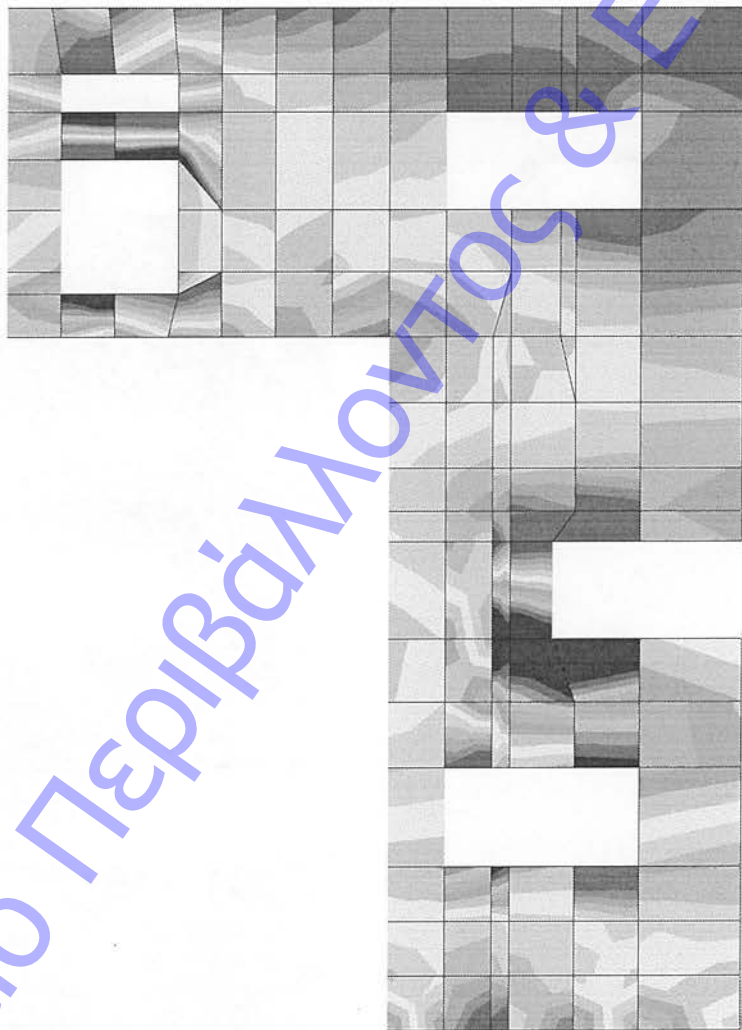

1.00 0.85 0.69 0.54 0.38 0.23 0.08 -0.08 -0.23 -0.38 -0.54 -0.69 -0.85 E+3



13 OPSI SEISMOS Y- S22

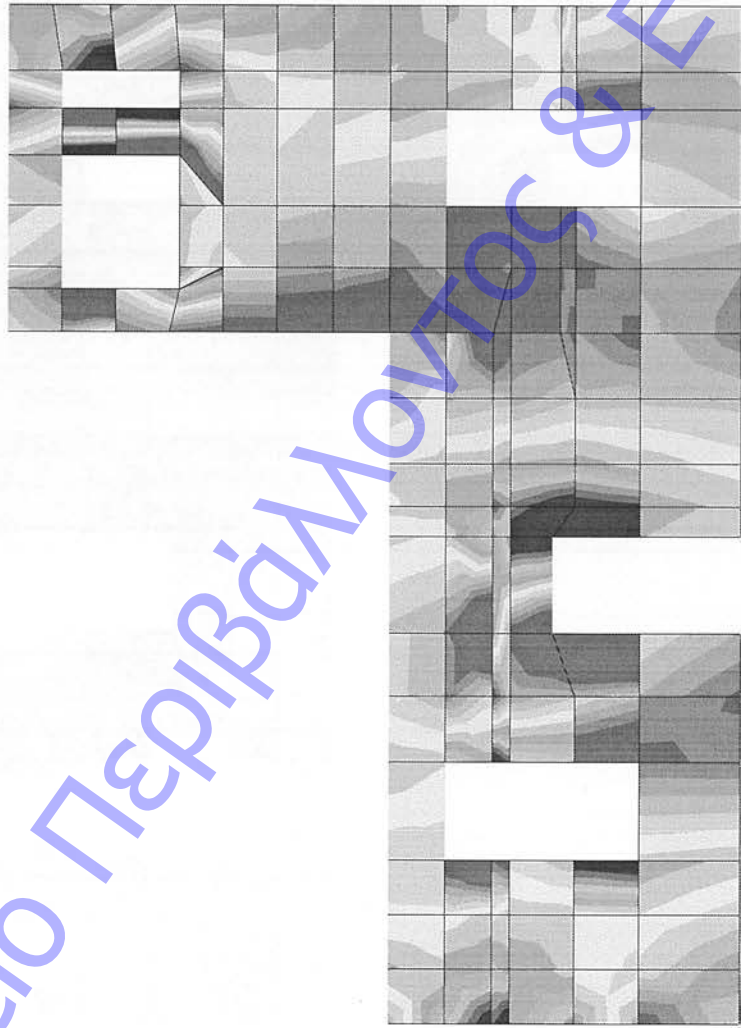

-1.00 -0.85 -0.69 -0.54 -0.38 -0.23 -0.08 -0.08 0.08 0.23 0.38 0.54 0.69 0.85 1.00 E+3



0003543A7F908851CD669C51C48E7881

ETABS

15 OPSI 135MON+150KIN-S22

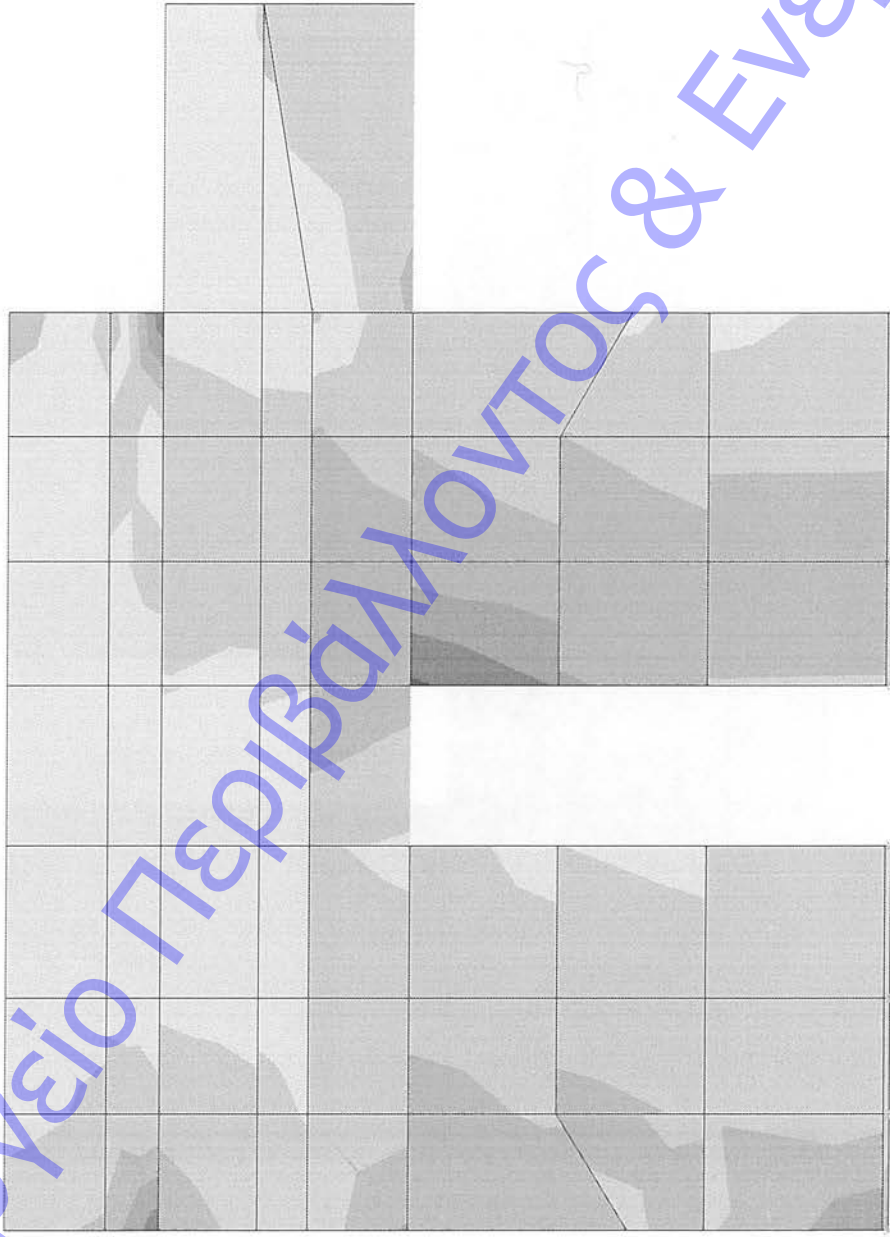



0003543A7F908851CD669C51C48E7881

ETABS

15 OPSI SEISMOS Y+ S22

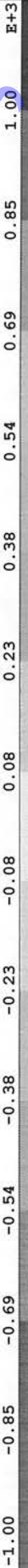
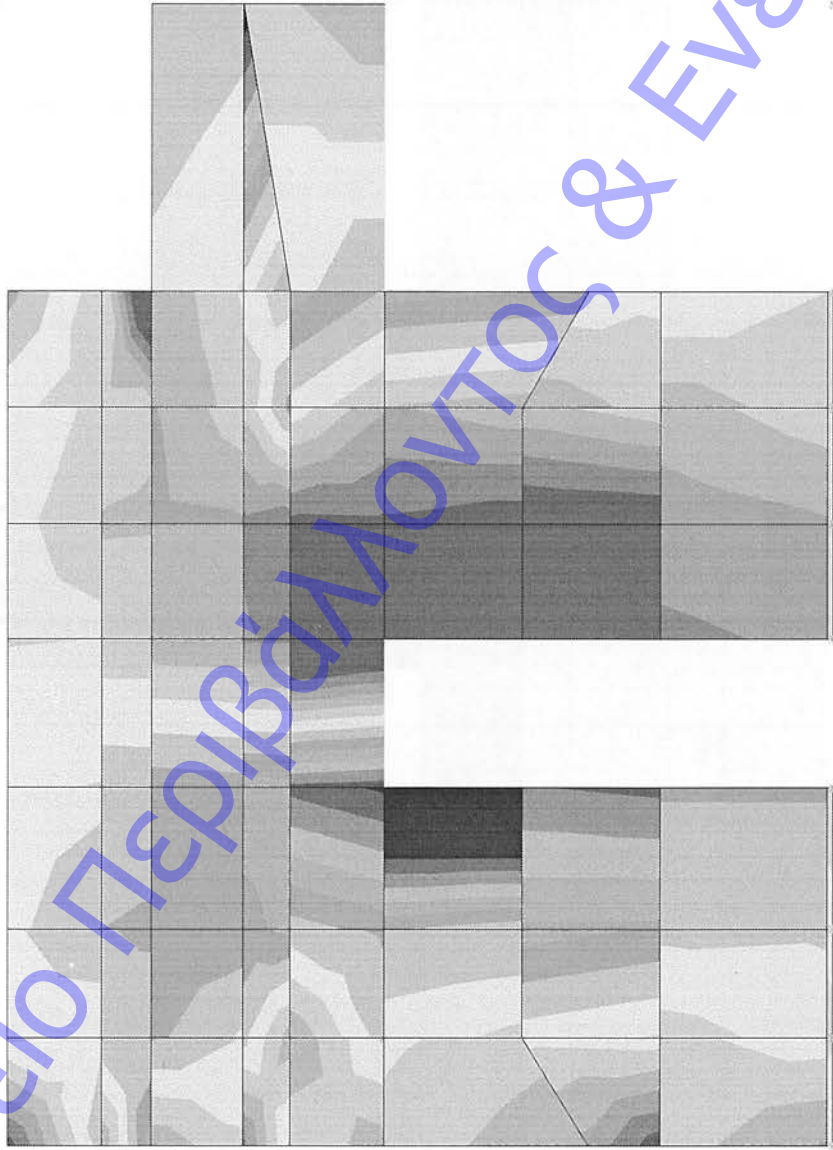



ETABS

15 OPSI SEISMOS Y-S22

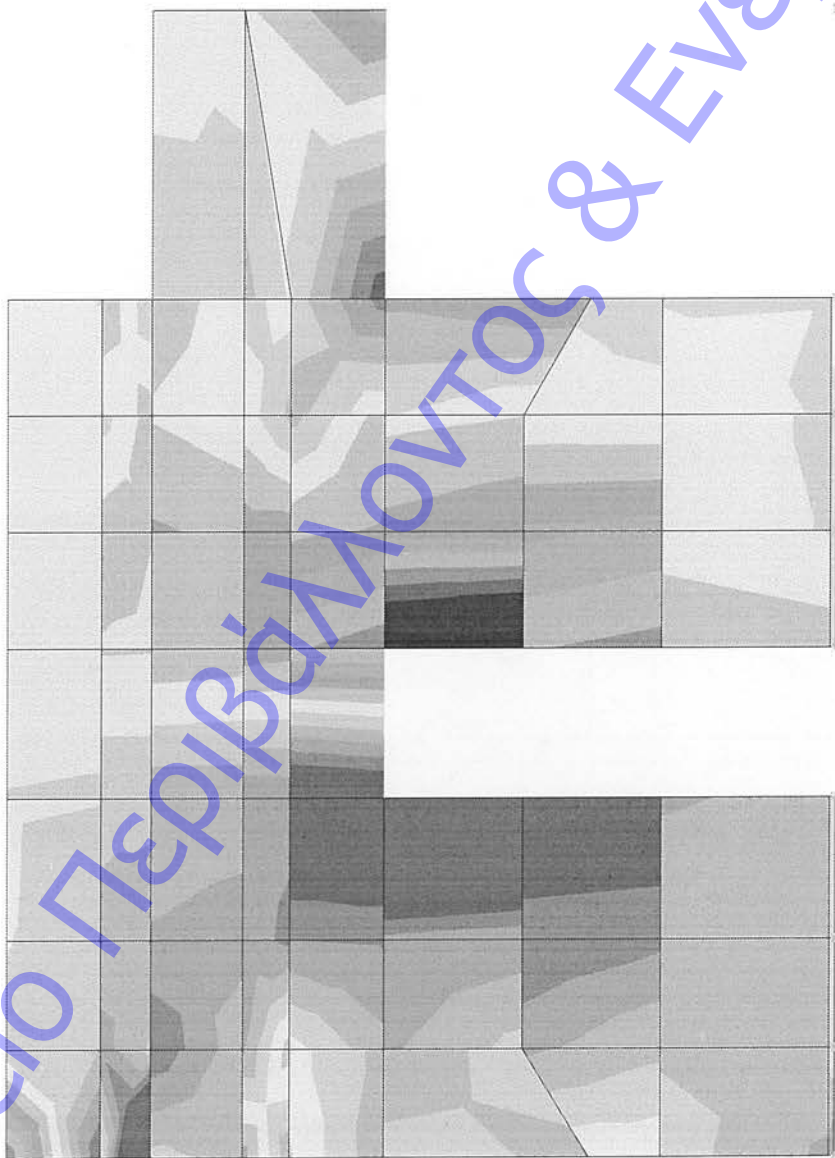

-0.85 -0.69 -0.54 -0.38 -0.23 -0.08 0.08 0.23 0.38 0.54 0.69 0.85 1.00 E+3



17 OPSI 135MON+150KIN-S22

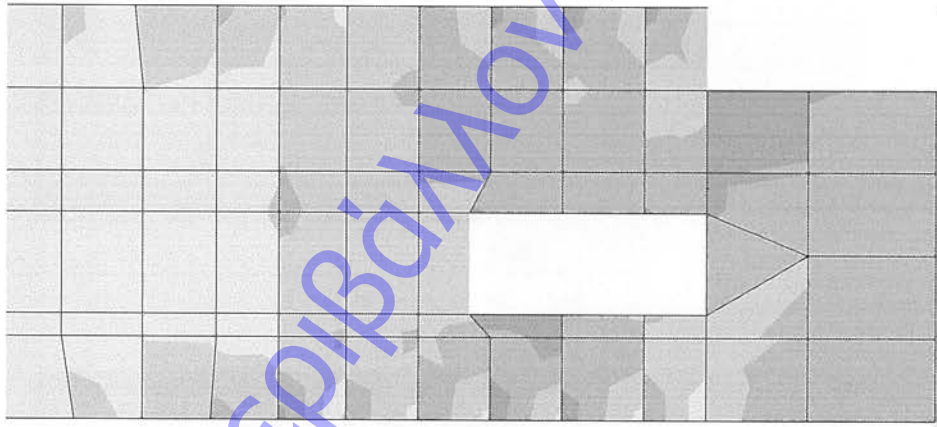

ΥΠΟΥΡΓΕΙΟ ΠΕΡΙΒΑΛΛΟΝΤΟΣ & ΕΝΕΡΓΕΙΑΣ

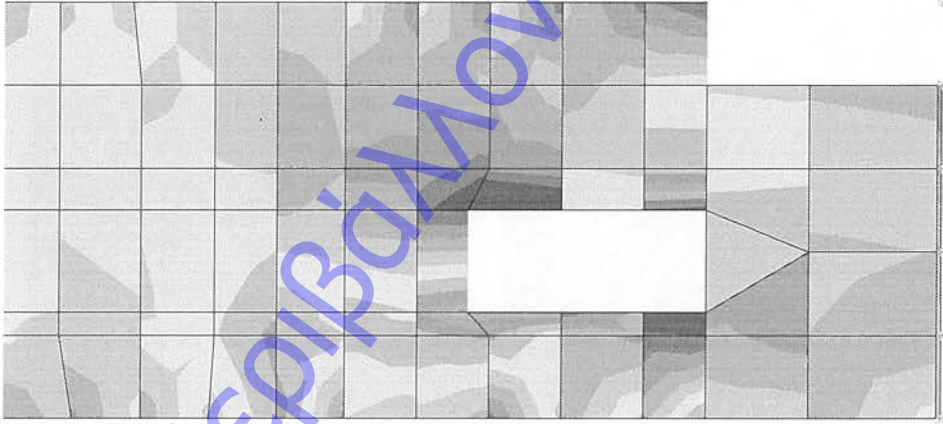

17 OPSI SEISMOS Y+ S22

0.85 -0.69 -0.54 -0.38 -0.23 -0.08 -0.08 0.08 0.23 0.38 0.54 0.69 0.85 1.00 E+3



ETABS

17 OPSI SEISMOS Y-S22

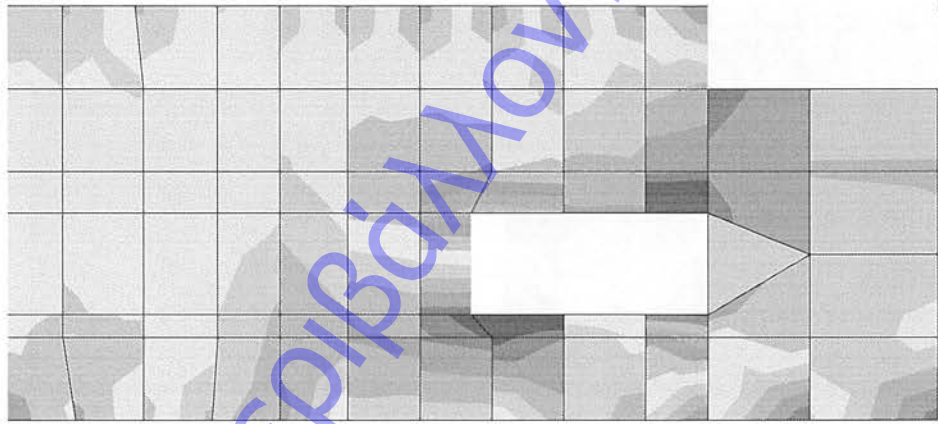

-1.00 -0.85 -0.69 -0.54 -0.38 -0.23 -0.08 0.08 0.23 0.38 0.54 0.69 0.85 1.00 E+3



0003543A7F90B851CD669C51C48E7881

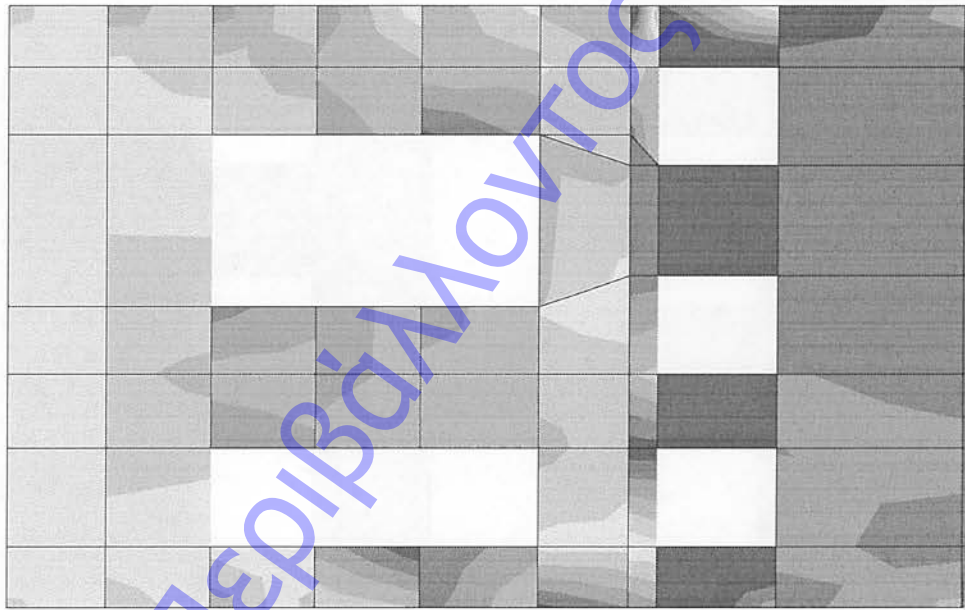

1.00 0.85 0.69 0.54 0.38 0.23 0.08 -0.08 -0.23 -0.38 -0.54 -0.69 1.00 E+3

ΤΜΗΜΑ Β_ ΤΕΥΧΟΣ_ΣΤΑΤΙΚΩΝ ΥΠΟΛΟΓΙΣΜΩΝ_ΠΡΟΤΑΣΗΣ_ΕΝΙΣΧΥΣΗΣ

ETABS v9.7.0 - File: ANATOLIKH_PTERYGA_20000_enisixisi - Οάδο γία ηέιό 22.2010 19:11
Elevation View - 18 Stress S22 Diagram (DGRAV) - KN-m Units



18 OPSI 135MON+150KIN-S22

ETABS

ΥΠΟΥΡΓΕΙΟ ΠΕΡΙΒΑΛΛΟΝΤΟΣ & ΕΝΕΡΓΕΙΑΣ



18 OPSI SEISMOS Y+ S22

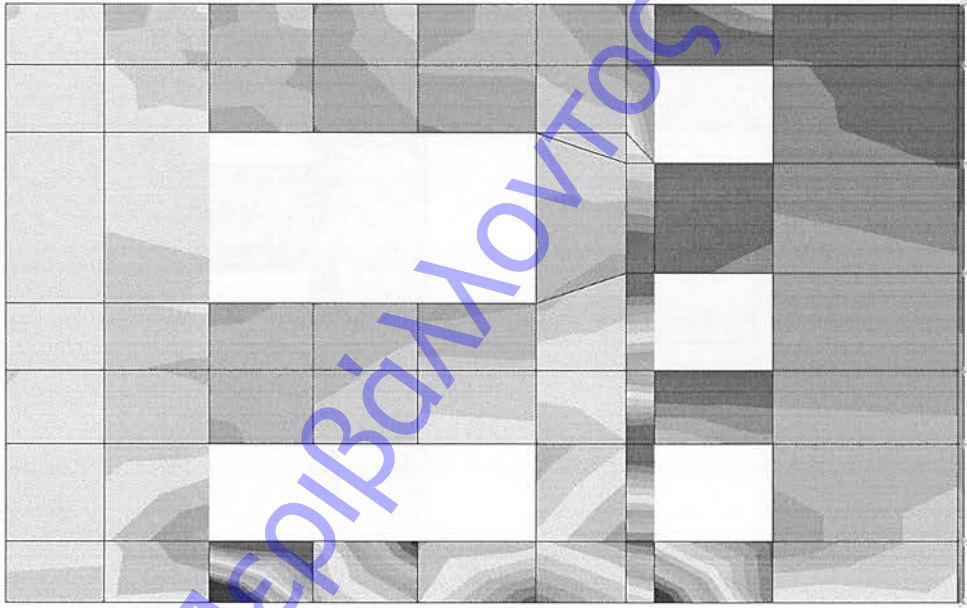

-1.00 -0.85 -0.69 -0.54 -0.38 -0.23 -0.08 0.08 0.23 0.38 0.54 0.69 0.85 1.00 E+3

18 OPSI SEISMOS Y- S22

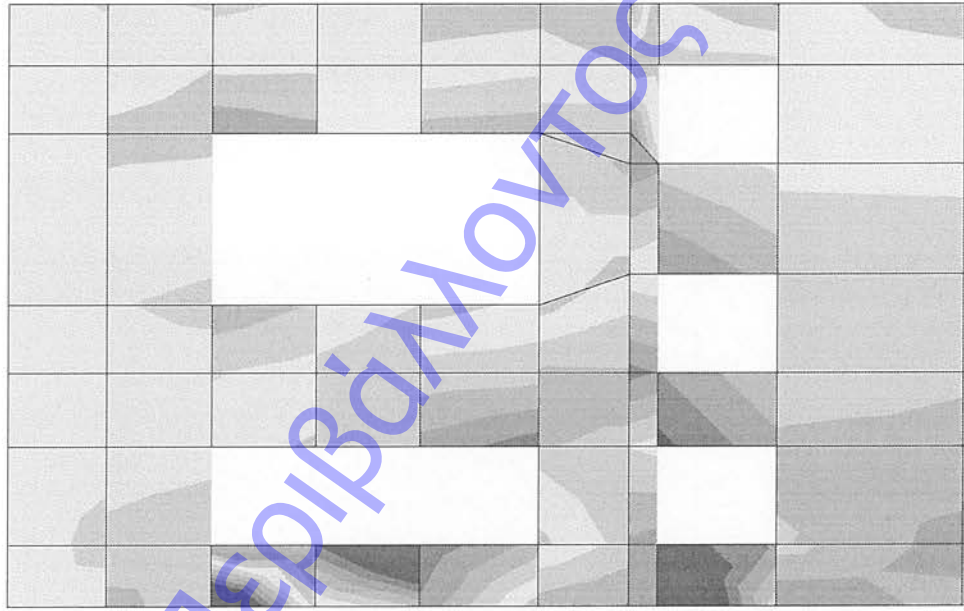

-0.85 -0.69 -0.54 -0.38 -0.23 -0.08 0.08 0.23 0.38 0.54 0.69 0.85 1.00 E+3





ETABS

20 OPSI 135ΜΟΝ+150ΚΙΝ-S22

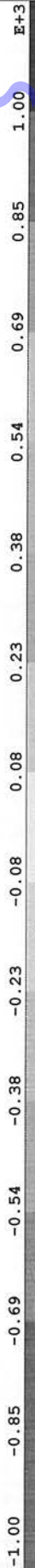
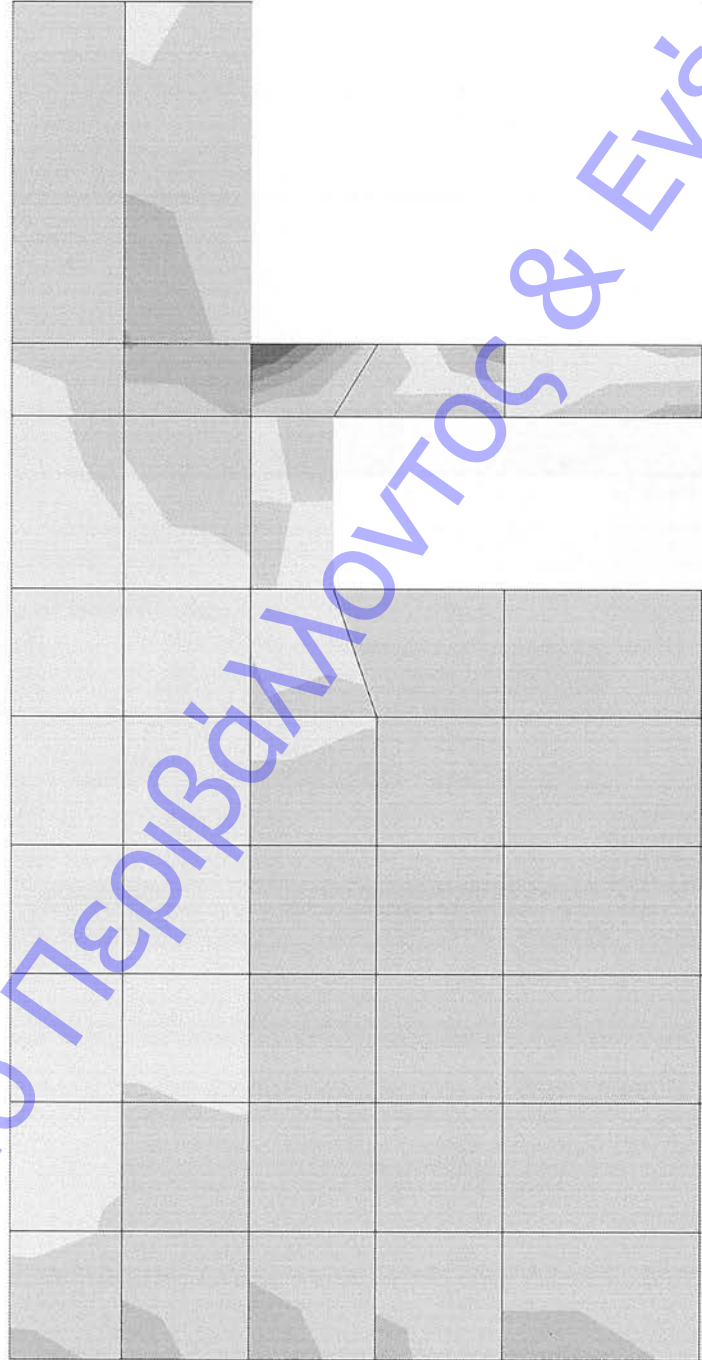

ETABS

20 OPSI SEISMOS Y+ S22

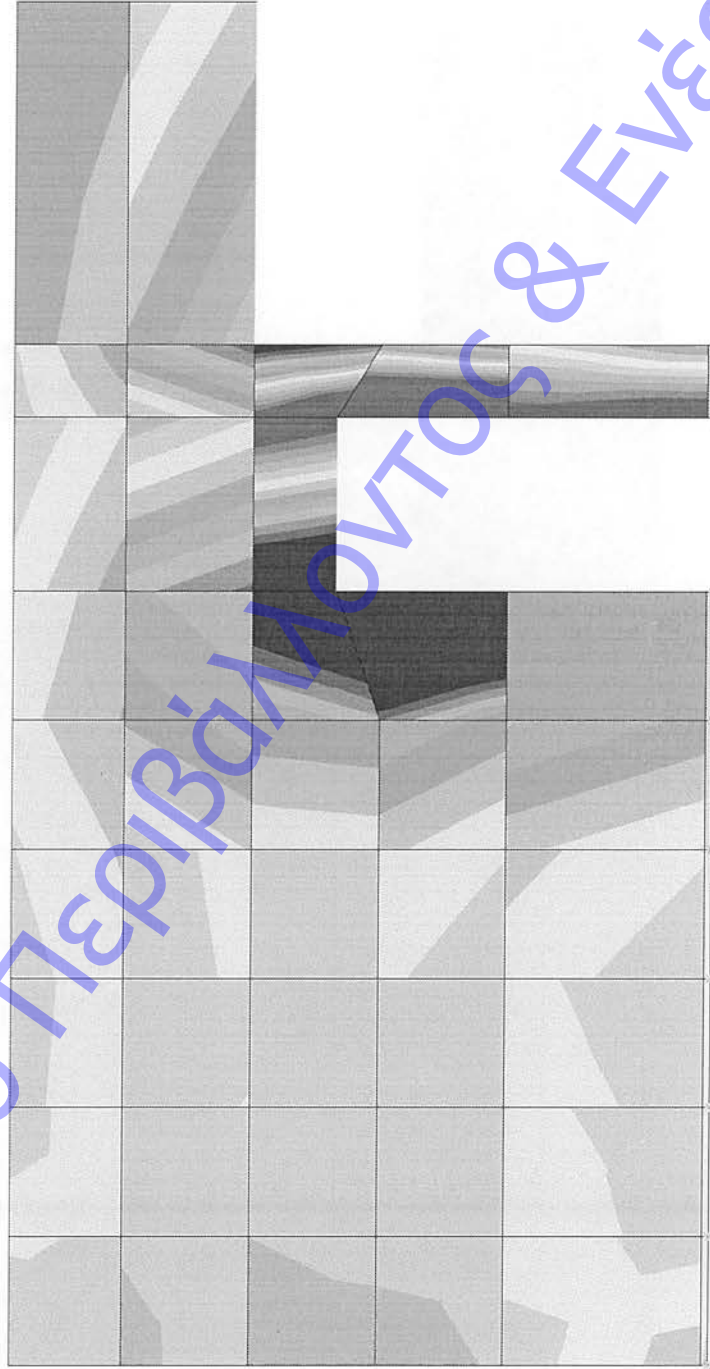

-0.85 -0.69 -0.54 -0.38 -0.23 -0.08 0.08 0.23 0.38 0.54 0.69 0.85 1.00 E+3





ETABS

20 OPSI SEISMOS Y- S22

